

# R&S®FSW-K70

## Vector Signal Analysis

### User Manual



1173.9292.02 – 04

This manual applies to the following R&S®FSW models with firmware version 1.51 and higher:

- R&S®FSW8 (1312.8000K08)
- R&S®FSW13 (1312.8000K13)
- R&S®FSW26 (1312.8000K26)

The following firmware options are described:

- R&S FSW-K70 (1313.1416.02)

The firmware of the instrument makes use of several valuable open source software packages. For information, see the "Open Source Acknowledgement" on the user documentation CD-ROM (included in delivery).

Rohde & Schwarz would like to thank the open source community for their valuable contribution to embedded computing.

© 2012 Rohde & Schwarz GmbH & Co. KG

Muehldorfstr. 15, 81671 Munich, Germany

Phone: +49 89 41 29 - 0

Fax: +49 89 41 29 12 164

E-mail: [info@rohde-schwarz.com](mailto:info@rohde-schwarz.com)

Internet: <http://www.rohde-schwarz.com>

Printed in Germany – Subject to change – Data without tolerance limits is not binding.

R&S® is a registered trademark of Rohde & Schwarz GmbH & Co. KG.

Trade names are trademarks of the owners.

The following abbreviations are used throughout this manual: R&S®FSW is abbreviated as R&S FSW.

# Contents

<b>1</b>	<b>Preface</b> .....	<b>7</b>
1.1	About this Manual.....	7
1.2	Documentation Overview.....	8
1.3	Conventions Used in the Documentation.....	9
<b>2</b>	<b>Welcome to the Vector Signal Analysis Application</b> .....	<b>11</b>
2.1	Starting the VSA Application.....	11
2.2	Understanding the Display Information.....	12
<b>3</b>	<b>Measurements and Result Displays</b> .....	<b>15</b>
3.1	Evaluation Data Sources in VSA.....	15
3.2	Result Types in VSA.....	19
3.3	Common Parameters in VSA.....	48
<b>4</b>	<b>Measurement Basics</b> .....	<b>50</b>
4.1	Filters and Bandwidths During Signal Processing.....	50
4.2	Sample Rate, Symbol Rate and I/Q Bandwidth.....	57
4.3	Symbol Mapping.....	63
4.4	Overview of the Demodulation Process.....	84
4.5	Signal Model, Estimation and Modulation Errors.....	96
4.6	Measurement Ranges.....	111
4.7	Display Points vs Estimation Points per Symbol.....	115
4.8	Known Data Files - Dependencies and Restrictions.....	116
4.9	VSA in MSRA Operating Mode.....	118
<b>5</b>	<b>Configuration</b> .....	<b>119</b>
5.1	Default Settings for Vector Signal Analysis.....	120
5.2	Configuration According to Digital Standards.....	121
5.3	Configuration Overview.....	123
5.4	Signal Description.....	126
5.5	Input and Frontend Settings.....	134
5.6	Signal Capture.....	151
5.7	Burst and Pattern Configuration.....	160
5.8	Result Range Configuration.....	169

5.9	Demodulation Settings.....	171
5.10	Measurement Filter Settings.....	179
5.11	Evaluation Range Configuration.....	181
5.12	Adjusting Settings Automatically.....	183
<b>6</b>	<b>Analysis.....</b>	<b>185</b>
6.1	Trace Settings.....	185
6.2	Trace Export Settings.....	188
6.3	Markers.....	189
6.4	Modulation Accuracy Limit Lines.....	194
6.5	Display and Window Configuration.....	196
6.6	Zoom Functions.....	199
<b>7</b>	<b>How to Perform Vector Signal Analysis.....</b>	<b>201</b>
7.1	How to Perform VSA According to Digital Standards.....	201
7.2	How to Perform Customized VSA Measurements.....	203
7.3	How to Analyze the Measured Data.....	212
<b>8</b>	<b>Measurement Examples.....</b>	<b>219</b>
8.1	Connecting the Transmitter and Analyzer.....	219
8.2	Measurement Example 1: Continuous QPSK Signal.....	220
8.3	Measurement Example 2: Burst GSM EDGE Signals.....	228
<b>9</b>	<b>Optimizing and Troubleshooting the Measurement.....</b>	<b>237</b>
9.1	Flow Chart for Troubleshooting.....	237
9.2	Explanation of Error Messages.....	239
9.3	Frequently Asked Questions.....	248
9.4	Obtaining Technical Support.....	255
<b>10</b>	<b>Remote Commands for VSA.....</b>	<b>257</b>
10.1	Introduction.....	257
10.2	Activating Vector Signal Analysis.....	262
10.3	Digital Standards.....	265
10.4	Configuring VSA.....	267
10.5	Performing a Measurement.....	326
10.6	Analysis.....	332
10.7	Configuring the Result Display.....	349

10.8	Retrieving Results.....	360
10.9	Status Reporting System.....	378
10.10	Obsolete Commands.....	388
10.11	Programming Examples.....	390
<b>A</b>	<b>Annex.....</b>	<b>398</b>
A.1	Predefined Standards and Settings.....	398
A.2	Predefined Measurement and Tx Filters.....	404
A.3	ASCII File Export Format for VSA Data.....	406
A.4	Known Data File Syntax Description.....	408
A.5	Formulae.....	410
A.6	Abbreviations.....	424
	<b>List of Remote Commands (VSA).....</b>	<b>426</b>
	<b>Index.....</b>	<b>436</b>



# 1 Preface

## 1.1 About this Manual

This R&S FSW Vector Signal Analysis User Manual provides all the information **specific to the application**. All general instrument functions and settings common to all applications and operating modes are described in the main R&S FSW User Manual.

The main focus in this manual is on the measurement results and the tasks required to obtain them. The following topics are included:


- **Welcome to the VSA Application**  
Introduction to and getting familiar with the application
- **Typical applications**  
Example measurement scenarios in which the application is frequently used.
- **Measurements and Result Displays**  
Details on supported measurements and their result types
- **Measurement Basics**  
Background information on basic terms and principles in the context of the measurement
- **Configuration + Analysis**  
A concise description of all functions and settings available to configure measurements and analyze results with their corresponding remote control command
- **How to Perform Measurements in VSA**  
The basic procedure to perform each measurement and step-by-step instructions for more complex tasks or alternative methods
- **Measurement Examples**  
Detailed measurement examples to guide you through typical measurement scenarios and allow you to try out the application immediately
- **Optimizing and Troubleshooting the Measurement**  
Hints and tips on how to handle errors and optimize the test setup
- **Remote Commands for VSA**  
Remote commands required to configure and perform VSA measurements in a remote environment, sorted by tasks  
(Commands required to set up the environment or to perform common tasks on the instrument are provided in the main R&S FSW User Manual)  
Programming examples demonstrate the use of many commands and can usually be executed directly for test purposes
- **Annex**  
Reference material
- **List of remote commands**  
Alphabetical list of all remote commands described in the manual
- **Index**

## 1.2 Documentation Overview

The user documentation for the R&S FSW consists of the following parts:

- "Getting Started" printed manual
- Online Help system on the instrument
- Documentation CD-ROM with:
  - Getting Started
  - User Manuals for base unit and options
  - Service Manual
  - Release Notes
  - Data sheet and product brochures

### Online Help

The Online Help is embedded in the instrument's firmware. It offers quick, context-sensitive access to the complete information needed for operation and programming. Online help is available using the  icon on the toolbar of the R&S FSW.

### Getting Started

This manual is delivered with the instrument in printed form and in PDF format on the CD. It provides the information needed to set up and start working with the instrument. Basic operations and handling are described. Safety information is also included.

The Getting Started manual in various languages is also available for download from the R&S website, on the R&S FSW product page at <http://www2.rohde-schwarz.com/product/FSW.html>.

### User Manuals

User manuals are provided for the base unit and each additional (software) option.

The user manuals are available in PDF format - in printable form - on the Documentation CD-ROM delivered with the instrument. In the user manuals, all instrument functions are described in detail. Furthermore, they provide a complete description of the remote control commands with programming examples.

The user manual for the base unit provides basic information on operating the R&S FSW in general, and the Spectrum application in particular. Furthermore, the software functions that enhance the basic functionality for various applications are described here. An introduction to remote control is provided, as well as information on maintenance, instrument interfaces and troubleshooting.

In the individual application manuals, the specific instrument functions of the application are described in detail. For additional information on default settings and parameters, refer to the data sheets. Basic information on operating the R&S FSW is not included in the application manuals.

All user manuals are also available for download from the R&S website, on the R&S FSW product page at <http://www2.rohde-schwarz.com/product/FSW.html>.



### Service Manual

This manual is available in PDF format on the CD delivered with the instrument. It describes how to check compliance with rated specifications, instrument function, repair, troubleshooting and fault elimination. It contains all information required for repairing the R&S FSW by replacing modules.

### Release Notes

The release notes describe the installation of the firmware, new and modified functions, eliminated problems, and last minute changes to the documentation. The corresponding firmware version is indicated on the title page of the release notes.

The most recent release notes are also available for download from the R&S website, on the R&S FSW product page at <http://www2.rohde-schwarz.com/product/FSW.html> > Downloads > Firmware.

## 1.3 Conventions Used in the Documentation

### 1.3.1 Typographical Conventions

The following text markers are used throughout this documentation:

Convention	Description
"Graphical user interface elements"	All names of graphical user interface elements on the screen, such as dialog boxes, menus, options, buttons, and softkeys are enclosed by quotation marks.
KEYS	Key names are written in capital letters.
File names, commands, program code	File names, commands, coding samples and screen output are distinguished by their font.
<i>Input</i>	Input to be entered by the user is displayed in italics.
<a href="#">Links</a>	Links that you can click are displayed in blue font.
"References"	References to other parts of the documentation are enclosed by quotation marks.

### 1.3.2 Conventions for Procedure Descriptions

When describing how to operate the instrument, several alternative methods may be available to perform the same task. In this case, the procedure using the touchscreen is described. Any elements that can be activated by touching can also be clicked using an additionally connected mouse. The alternative procedure using the keys on the instrument or the on-screen keyboard is only described if it deviates from the standard operating procedures.

The term "select" may refer to any of the described methods, i.e. using a finger on the touchscreen, a mouse pointer in the display, or a key on the instrument or on a keyboard.

## 2 Welcome to the Vector Signal Analysis Application

The R&S FSW-K70 is a firmware application that adds functionality to perform Vector Signal Analysis (VSA) to the R&S FSW.

The VSA application performs vector and scalar measurements on digitally modulated single-carrier signals. To perform the measurements it converts RF signals into the complex baseband. It can also use the optional Digital Baseband interface (R&S FSW-B17 option) to analyze I/Q signals already delivered to the complex baseband.

The VSA application features:

- Flexible modulation analysis from MSK to 64QAM
- Numerous standard-specific default settings
- Various graphical, numerical and statistical evaluations and result displays
- Spectrum analyses of the measurement and error signal
- Flexible burst search for the analysis of complex signal combinations, short bursts or signal mix

This user manual contains a description of the functionality that the application provides, including remote control operation.

All functions not discussed in this manual are the same as in the base unit and are described in the R&S FSW User Manual. The latest version is available for download at the product homepage (<http://www2.rohde-schwarz.com/product/FSW.html>).

### Installation

You can find detailed installation instructions in the R&S FSW Getting Started manual or in the Release Notes.

## 2.1 Starting the VSA Application

The VSA application adds a new application to the R&S FSW.

### To activate the VSA application

1. Press the MODE key on the front panel of the R&S FSW.  
A dialog box opens that contains all operating modes and applications currently available on your R&S FSW.
2. Select the "VSA" item.



The R&S FSW opens a new measurement channel for the VSA application.


The measurement is started immediately with the default settings. It can be configured in the VSA "Overview" dialog box, which is displayed when you select the "Overview" softkey from any menu (see [chapter 5.3, "Configuration Overview"](#), on page 123).

### Multiple Measurement Channels and Sequencer Function

When you activate an application, a new measurement channel is created which determines the measurement settings for that application. The same application can be activated with different measurement settings by creating several channels for the same application.

The number of channels that can be configured at the same time depends on the available memory on the instrument.

Only one measurement can be performed at any time, namely the one in the currently active channel. However, in order to perform the configured measurements consecutively, a Sequencer function is provided.

If activated, the measurements configured in the currently active channels are performed one after the other in the order of the tabs. The currently active measurement is indicated by a  symbol in the tab label. The result displays of the individual channels are updated in the tabs (including the "MultiView") as the measurements are performed. Sequential operation itself is independent of the currently *displayed* tab.

For details on the Sequencer function see the R&S FSW User Manual.

## 2.2 Understanding the Display Information

The following figure shows a measurement diagram during analyzer operation. All different information areas are labeled. They are explained in more detail in the following sections.



- 1 = Channel bar for firmware and measurement settings
- 2+3 = Window title bar with diagram-specific (trace) information
- 4 = Diagram area
- 5 = Diagram footer with diagram-specific information, depending on measurement application
- 6 = Instrument status bar with error messages, progress bar and date/time display



### MSRA operating mode

In MSRA operating mode, additional tabs and elements are available. A colored background of the screen behind the measurement channel tabs indicates that you are in MSRA operating mode.

For details on the MSRA operating mode see the R&S FSW MSRA User Manual.

### Channel bar information

In VSA application, the R&S FSW shows the following settings:

**Table 2-1: Information displayed in the channel bar in VSA application**

<b>Ref Level</b>	Reference level
<b>Freq</b>	Center frequency for the RF signal
<b>Mod</b>	Modulation type, if no standard is active (or default standard is changed)
<b>Res Len</b>	Result Length
<b>SR</b>	Symbol Rate
<b>Att</b>	Mechanical and electronic RF attenuation
<b>Offset</b>	Reference level offset
<b>Cap Len</b>	Capture Length (instead of result length for capture buffer display), see <a href="#">"Capture Length Settings"</a> on page 152
<b>Input</b>	Input type of the signal source, see <a href="#">chapter 5.5.1, "Input Settings"</a> , on page 134
<b>Burst</b>	Burst search active (see <a href="#">"Enabling Burst Searches"</a> on page 162)
<b>Pattern</b>	Pattern search active (see <a href="#">"Enabling Pattern Searches"</a> on page 163)
<b>Stat Count</b>	Statistics count for averaging and other statistical operations, see <a href="#">"Statistic Count"</a> on page 159; cannot be edited directly
<b>Capt Count</b>	Capture count; the current number of captures performed if several captures are necessary to obtain the number of results defined by "Statistics Count"; cannot be edited directly
<b>SGL</b>	The sweep is set to single sweep mode.

In addition, the channel bar also displays information on instrument settings that affect the measurement results even though this is not immediately apparent from the display of the measured values (e.g. transducer or trigger settings). This information is displayed only when applicable for the current measurement. For details see the R&S FSW Getting Started manual.

### Window title bar information

For each diagram, the header provides the following information:



**Fig. 2-1: Window title bar information in VSA application**

- 1 = Window name
- 2 = Result type
- 3 = Data source type
- 4 = Trace color
- 5 = Displayed signal for Meas&Ref data source: M (Meas) or R (Ref)
- 6 = Trace mode

### Diagram area

The diagram area displays the results according to the selected result displays (see [chapter 3, "Measurements and Result Displays"](#), on page 15).

### Diagram footer information

The diagram footer (beneath the diagram) contains the start and stop symbols or time of the evaluation range.

### Status bar information

Global instrument settings, the instrument status and any irregularities are indicated in the status bar beneath the diagram. Furthermore, the progress of the current operation is displayed in the status bar.

### 3 Measurements and Result Displays

Various different result displays for VSA measurements are available. Which result types are available depends on the selected data source. You can define which part of the measured signal is to be evaluated and displayed.

The determined result and evaluation ranges are included in the result displays (where useful) to visualize the basis of the displayed values and traces.

For background information on the result and evaluation ranges see [chapter 4.6, "Measurement Ranges"](#), on page 111.)

- [Evaluation Data Sources in VSA](#).....15
- [Result Types in VSA](#).....19
- [Common Parameters in VSA](#).....48

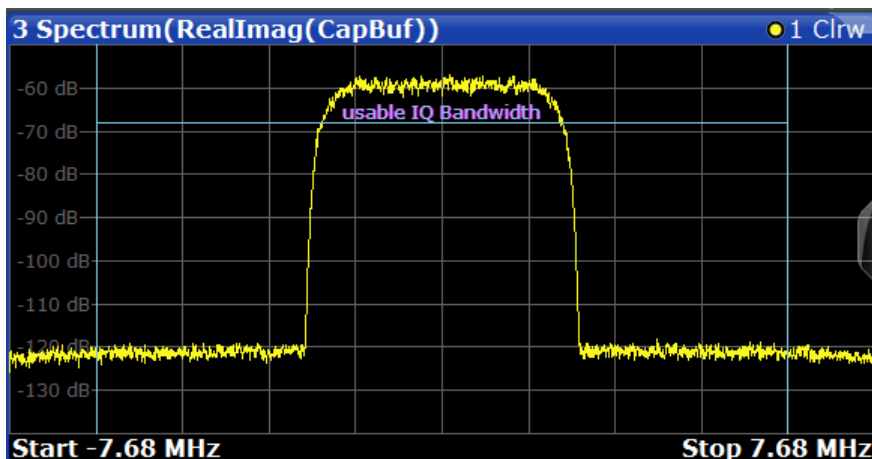
#### 3.1 Evaluation Data Sources in VSA

All data sources for evaluation available for VSA are displayed in the evaluation bar in SmartGrid mode. The data source determines which result types are available (see [table 3-1](#)).

For details on selecting the data source for evaluation see [chapter 6.5, "Display and Window Configuration"](#), on page 196.



In diagrams in the frequency domain (Spectrum transformation, see ["Result Type Transformation"](#) on page 197) the usable I/Q bandwidth is indicated by vertical blue lines.



- [Capture Buffer](#).....16
- [Measurement & Reference Signal](#).....16
- [Symbols](#).....17
- [Error Vector](#).....17

Modulation Errors.....	17
Modulation Accuracy.....	18
Equalizer.....	18

### Capture Buffer

The captured I/Q data

In capture buffer result diagrams the result ranges are indicated by green bars along the time axis. The currently displayed result range is indicated by a blue bar.

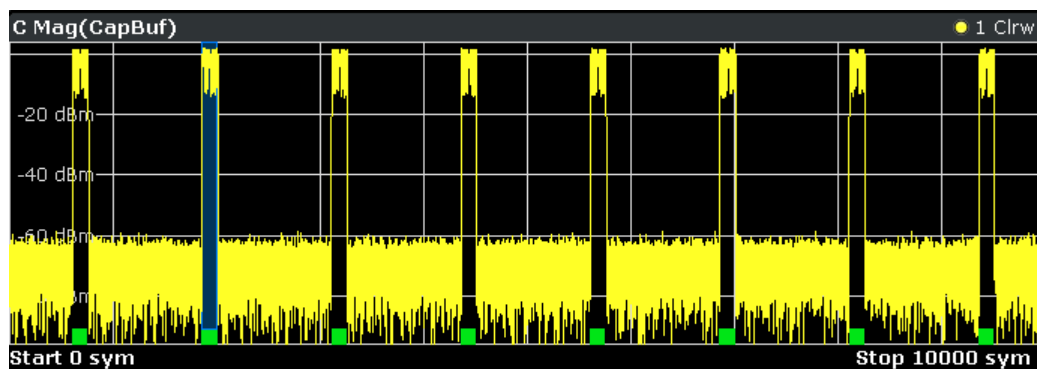


Fig. 3-1: Result ranges for a burst signal

**Note: Tip:** You can use the capture buffer display to navigate through the available result ranges (using [Select Result Rng](#) softkey), and analyze the individual result ranges in separate windows.

You can change the position of the result range quickly and easily by dragging the blue bar representing the result range to a different position in the capture buffer.

The default result type is "Magnitude Absolute".

The following result types are available:

- [chapter 3.2.1, "Magnitude Absolute"](#), on page 21
- [chapter 3.2.7, "Real/Imag \(I/Q\)"](#), on page 26
- [chapter 3.2.5, "Frequency Absolute"](#), on page 24
- [chapter 3.2.13, "Vector I/Q"](#), on page 31

SCPI command:

LAY:ADD? '1',BEL,MTAB(see [LAYout:ADD\[:WINDow\]?](#) on page 351)

### Measurement & Reference Signal

The measurement signal or the ideal reference signal (or both)

The default result type is "Magnitude Relative".

The following result types are available:

- [chapter 3.2.1, "Magnitude Absolute"](#), on page 21
- [chapter 3.2.2, "Magnitude Relative"](#), on page 22
- [chapter 3.2.3, "Phase Wrap"](#), on page 22
- [chapter 3.2.4, "Phase Unwrap"](#), on page 23
- [chapter 3.2.5, "Frequency Absolute"](#), on page 24
- [chapter 3.2.6, "Frequency Relative"](#), on page 25
- [chapter 3.2.7, "Real/Imag \(I/Q\)"](#), on page 26
- [chapter 3.2.8, "Eye Diagram Real \(I\)"](#), on page 27



- [chapter 3.2.9, "Eye Diagram Imag \(Q\)", on page 28](#)
- [chapter 3.2.10, "Eye Diagram Frequency", on page 29](#)
- [chapter 3.2.11, "Constellation I/Q", on page 30](#)
- [chapter 3.2.13, "Vector I/Q", on page 31](#)
- [chapter 3.2.14, "Constellation Frequency", on page 32](#)
- [chapter 3.2.15, "Vector Frequency", on page 33](#)

SCPI command:

LAY:ADD? '1', BEL, REF(see [LAYout:ADD\[:WINDOW\]? on page 351](#))

### Symbols

The detected symbols (i.e. the detected bits) displayed in a table

The default result type is a hexadecimal symbol table.

Other formats for the symbol table are available, but no other result types (see [chapter 3.2.16, "Symbol Table", on page 33](#)).

SCPI command:

LAY:ADD? '1', BEL, SYMB(see [LAYout:ADD\[:WINDOW\]? on page 351](#))

### Error Vector

The modulated difference between the complex measurement signal and the complex reference signal:

Modulation (measurement signal - reference signal)

For example:  $EVM = \text{Mag}(\text{meas} - \text{ref})$

The default result type is "EVM".

The following result types are available:

- [chapter 3.2.17, "Error Vector Magnitude \(EVM\)", on page 34](#)
- [chapter 3.2.7, "Real/Imag \(I/Q\)", on page 26](#)
- [chapter 3.2.13, "Vector I/Q", on page 31](#)

SCPI command:

LAY:ADD? '1', BEL, EVEC(see [LAYout:ADD\[:WINDOW\]? on page 351](#))

### Modulation Errors

The difference between the modulated complex samples in the measurement and the modulated reference signal:

Modulation (measurement signal) - Modulation (reference signal)

For example:  $\text{Magnitude Error} = \text{Mag}(\text{meas}) - \text{Mag}(\text{ref})$

The default result type is "Magnitude Error".

The following result types are available:

- [chapter 3.2.1, "Magnitude Absolute", on page 21](#)
- [chapter 3.2.19, "Phase Error", on page 36](#)
- [chapter 3.2.20, "Frequency Error Absolute", on page 37](#)
- [chapter 3.2.21, "Frequency Error Relative", on page 38](#)

SCPI command:

LAY:ADD? '1', BEL, MERR(see [LAYout:ADD\[:WINDOW\]? on page 351](#))

### Modulation Accuracy

Parameters that characterize the accuracy of modulation.

The default result type is "Result Summary".

The following result types are available:

- [chapter 3.2.22, "Result Summary"](#), on page 39
- [chapter 3.2.23, "Bit Error Rate \(BER\)"](#), on page 42

The results of a modulation accuracy measurement can be checked for violation of defined limits automatically. If limit check is activated and the measured values exceed the limits, those values are indicated in red in the result summary table. If limit check is activated and no values exceed the limits, the checked values are indicated in green.

1 Result Summary		Current	Peak	Unit
*EVM	RMS	12.59*	12.59	%
*	Peak	103.31*	103.31	%
MER	RMS	18.00	18.00	dB
	Peak	-0.28	-0.28	dB
Phase Error	RMS	6.62	6.62	deg
	Peak	44.67	44.67	deg
Magnitude Error	RMS	5.04	5.04	%
	Peak	48.74	48.74	%
Carrier Frequency Error		-201.04	-201.04	Hz
Rho		0.984 404	0.984 404	
I/Q Offset		-40.15	-40.15	dB
I/Q Imbalance		-57.56	-57.56	dB
Gain Imbalance		0.01	0.01	dB
Quadrature Error		0.14	0.14	deg
Amplitude Droop		-0.000 53	0.000 005	dB/sym

SCPI command:

LAY:ADD? '1', BEL, MACC(see [LAYout:ADD\[:WINDow\]?](#) on page 351)

### Equalizer

Filter characteristics of the equalizer used to compensate for channel distortion and parameters of the distortion itself.

The default result type is "Frequency Response Magnitude".

The following result types are available:

- [chapter 3.2.24, "Impulse Response Magnitude"](#), on page 44
- [chapter 3.2.25, "Impulse Response Phase"](#), on page 44
- [chapter 3.2.26, "Impulse Response Real/Imag"](#), on page 45
- [chapter 3.2.27, "Frequency Response Magnitude"](#), on page 45
- [chapter 3.2.28, "Frequency Response Phase"](#), on page 46
- [chapter 3.2.29, "Group Delay"](#), on page 46
- [chapter 3.2.30, "Channel Frequency Response Magnitude"](#), on page 47
- [chapter 3.2.31, "Channel Group Delay"](#), on page 48

SCPI command:

LAY:ADD? '1', BEL, EQU(see [LAYout:ADD\[:WINDow\]?](#) on page 351)

## 3.2 Result Types in VSA

The available result types for a window depend on the selected evaluation data source.

**Table 3-1: Available result types depending on data source**

Evaluation Data Source	Result Type	SCPI Parameter
Capture Buffer	Magnitude Absolute	MAGNitude
	Real/Imag (I/Q)	RIMag
	Frequency Absolute	FREQUENCY
	Vector I/Q	COMP
Meas & Ref Signal	Magnitude Absolute	MAGNitude
	Magnitude Relative	MAGNitude
	Phase Wrap	PHASe
	Phase Unwrap	UPHase
	Frequency Absolute	FREQUENCY
	Frequency Relative	FREQUENCY
	Real/Imag (I/Q)	RIMag
	Eye Diagram Real (I)	IEYE
	Eye Diagram Imag (Q)	QEYE
	Eye Diagram Frequency	FEYE
	Constellation I/Q	CONS
	Constellation I/Q (Rotated)	RCON
	Vector I/Q	COMP
	Constellation Frequency	CONF
Vector Frequency	COVF	
Symbols	Binary	-
	Octal	-
	Decimal	-
	Hexadecimal	-
Error Vector	EVM	MAGNitude
	Real/Imag (I/Q)	RIMag
	Vector I/Q	COMP
Modulation Errors	Magnitude Error	MAGNitude
	Phase Error	PHASe
	Frequency Error Absolute	FREQUENCY

Evaluation Data Source	Result Type	SCPI Parameter
	Frequency Error Relative	FREquency
Modulation Accuracy	Bit Error Rate	BERate
	Result Summary	RSUM
Equalizer	Impulse Response Magnitude	MAGNitude
	Impulse Response Phase	UPHase
	Impulse Response Real/Image	RIMag
	Frequency Response Magnitude	MAGNitude
	Frequency Response Phase	UPHase
	Group Delay	GDElay
	Channel Frquency Response Magnitude	MAGNitude
	Channel Group Delay	GDElay

For details on selecting the data source and result types for evaluation see [chapter 6.5, "Display and Window Configuration"](#), on page 196.

#### SCPI command:

[CALCulate<n>:FORMat](#) on page 357

• Magnitude Absolute.....	21
• Magnitude Relative.....	22
• Phase Wrap.....	22
• Phase Unwrap.....	23
• Frequency Absolute.....	24
• Frequency Relative.....	25
• Real/Imag (I/Q).....	26
• Eye Diagram Real (I).....	27
• Eye Diagram Imag (Q).....	28
• Eye Diagram Frequency.....	29
• Constellation I/Q.....	30
• Constellation I/Q (Rotated).....	30
• Vector I/Q.....	31
• Constellation Frequency.....	32
• Vector Frequency.....	33
• Symbol Table.....	33
• Error Vector Magnitude (EVM).....	34
• Magnitude Error.....	35
• Phase Error.....	36
• Frequency Error Absolute.....	37
• Frequency Error Relative.....	38
• Result Summary.....	39
• Bit Error Rate (BER).....	42
• Impulse Response Magnitude.....	44

• Impulse Response Phase.....	44
• Impulse Response Real/Imag.....	45
• Frequency Response Magnitude.....	45
• Frequency Response Phase.....	46
• Group Delay.....	46
• Channel Frequency Response Magnitude.....	47
• Channel Group Delay.....	48

### 3.2.1 Magnitude Absolute

Magnitude of the source signal; the actual signal amplitude is displayed

$$Mag_{MEAS}(t) = |MEAS(t)|$$

with  $t = n \cdot T_D$  and  $T_D$  = the duration of one sampling period at the sample rate defined by the display points per symbol parameter (see "Display Points/Sym" on page 198).

Available for source types:

- Capture Buffer
- Meas & Ref Signal

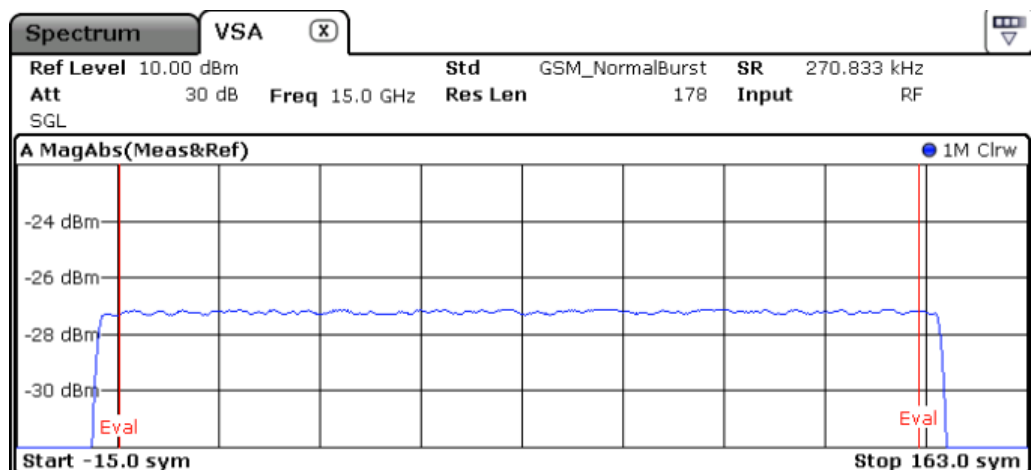


Fig. 3-2: Result display "Magnitude Absolute" for capture buffer data with normal transformation

#### SCPI commands:

```
LAY:ADD? '1',BEL,CBUF
```

to define the required source type (see `LAYout:ADD[:WINDow]?` on page 351)

```
CALC:FORM MAGN
```

to define the result type (see `CALCulate<n>:FORMat` on page 357)

```
TRAC:DATA
```

to query the trace results (see `TRACe<n>[:DATA]` on page 363)

### 3.2.2 Magnitude Relative

Magnitude of the source signal; the signal amplitude is scaled to the ideal reference signal

Available for source types:

- Meas & Ref Signal

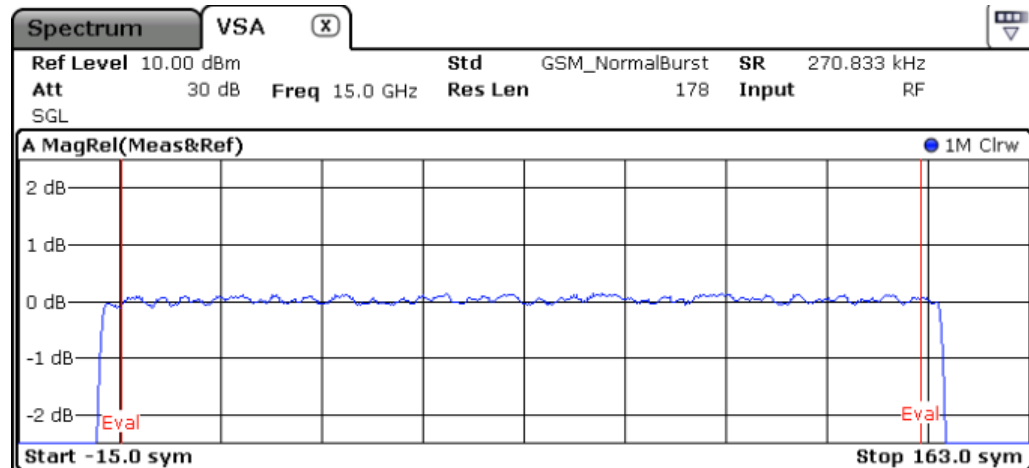


Fig. 3-3: Result display "Magnitude Relative" in normal mode

#### SCPI commands:

```
LAY:ADD? '1',BEL,MEAS
```

to define the required source type (see [LAYout:ADD\[:WINDow\]?](#) on page 351)

```
CALC:FORM MAGN
```

to define the result type (see [CALCulate<n>:FORMat](#) on page 357)

```
DISP:TRAC:Y:MODE REL
```

to define relative values (see [DISPlay\[:WINDow<n>\]:TRACe:Y\[:SCALE\]:MODE](#) on page 360)

```
TRAC:DATA TRACE1
```

to query the trace results (see [TRACe<n>\[:DATA\]](#) on page 363)

### 3.2.3 Phase Wrap

The phase or argument of the signal; the display is limited to the phase value range of  $[-180^\circ, 180^\circ]$

$$Phase_{MEAS}(t) = \angle(MEAS(t))$$

with  $t = n \cdot T_D$  and  $T_D$  = the duration of one sampling period at the sample rate defined by the display points per symbol parameter (see ["Display Points/Sym"](#) on page 198).

Available for source types:

- Meas & Ref Signal

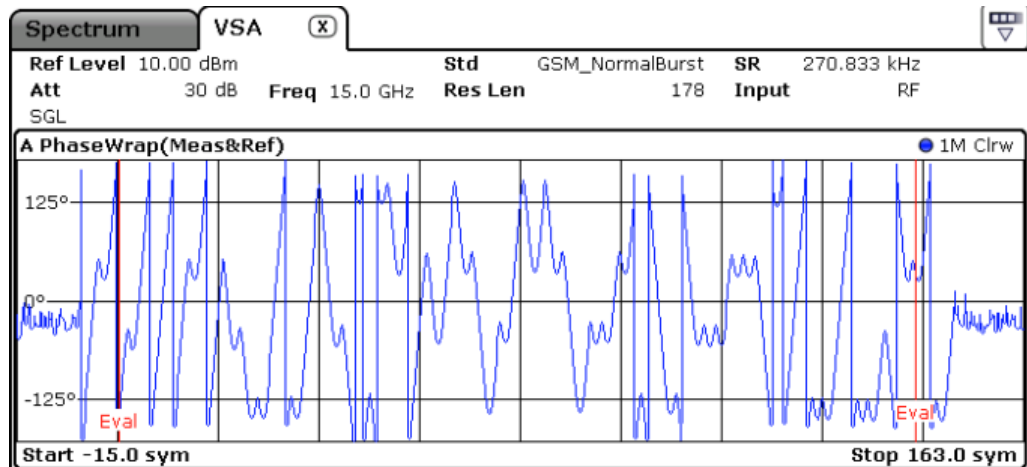


Fig. 3-4: Result display "Phase Wrap" in normal mode

#### SCPI commands:

```
LAY:ADD? '1',BEL,REF
```

to define the required source type (see [LAYout:ADD\[:WINDow\]?](#) on page 351)

```
CALC:FORM PHASe
```

to define the result type (see [CALCulate<n>:FORMat](#) on page 357)

```
TRAC:DATA TRACE1
```

to query the trace results (see [TRACe<n>\[:DATA\]](#) on page 363)

### 3.2.4 Phase Unwrap

The phase of the signal; the display is not limited to  $[-180^\circ, 180^\circ]$ .

Available for source types:

- Meas & Ref Signal

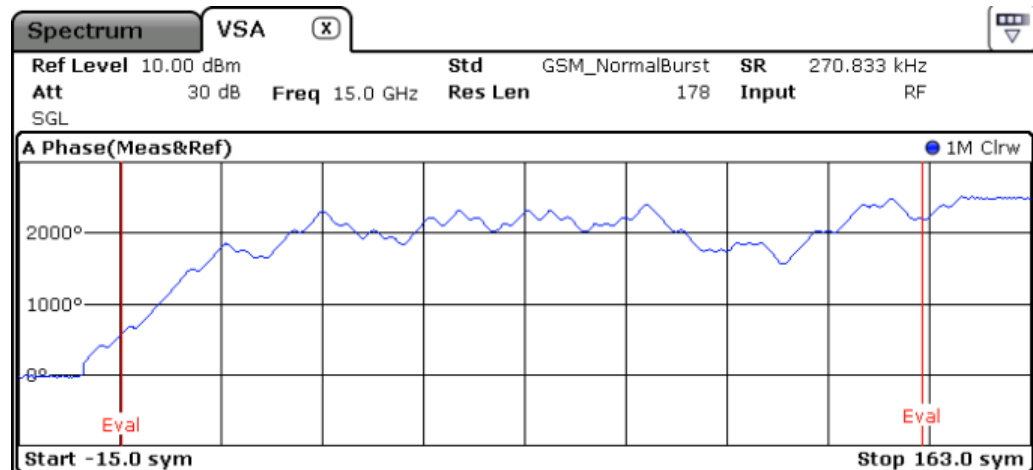


Fig. 3-5: Result display "Phase Unwrap" in normal mode

#### SCPI commands:

```
LAY:ADD? '1',BEL,MEAS
```

to define the required source type (see [LAYout:ADD\[:WINDow\]?](#) on page 351)

```
CALC:FORM UPHase
```

to define the result type (see [CALCulate<n>:FORMat](#) on page 357)

```
TRAC:DATA TRACE1
```

to query the trace results (see [TRACe<n>\[:DATA\]](#) on page 363)

### 3.2.5 Frequency Absolute

The instantaneous frequency of the signal source; the absolute value is displayed in Hz.

Available for source types:

- Meas & Ref Signal
- Capture Buffer

#### Meas&Ref signal:

$$FREQ_{MEAS}(t) = \frac{1}{2 \cdot \pi} \frac{d}{dt} \angle MEAS(t)$$

with  $t = n \cdot T_D$  and  $T_D$  = the duration of one sampling period at the sample rate defined by the display points per symbol parameter (see ["Display Points/Sym"](#) on page 198).

#### Capture buffer:

$$FREQ_{CAPT.}(t) = \frac{1}{2 \cdot \pi} \frac{d}{dt} \angle Capt(t)$$



When evaluating the capture buffer, the absolute frequency is derived from the measured phase, with  $T_D$  = the duration of one sampling period at the sample rate (see "Sample Rate" on page 153).



This measurement is mainly of interest when using the MSK or FSK modulation, but can also be used for the PSK/QAM modulations. However, since these modulations can have transitions through zero in the I/Q plane, in this case you might notice uncritical spikes. This is due to the fact that the phase of zero (or a complex value close to zero) is of limited significance, but still influences the result of the instantaneous frequency measurement.

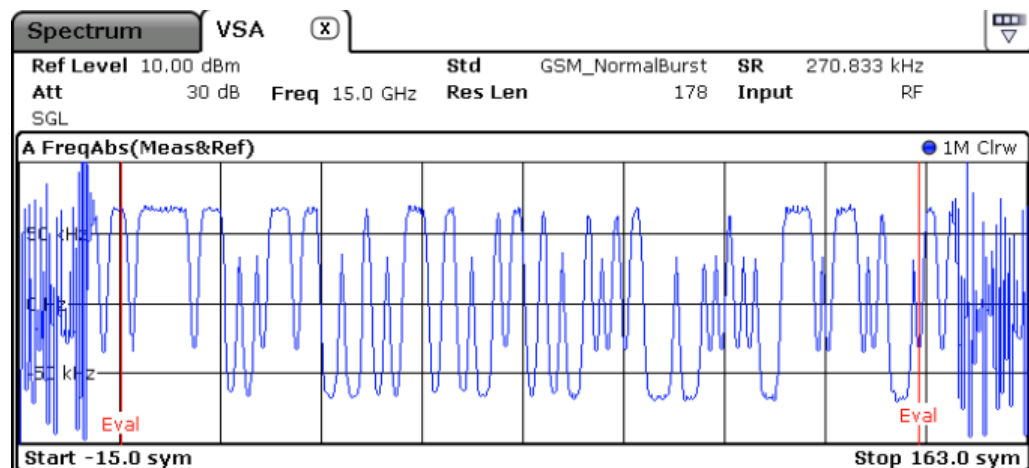


Fig. 3-6: Result display "Frequency Absolute" in normal mode

#### SCPI commands:

```
LAY:ADD? '1',BEL,MEAS
```

to define the required source type (see `LAYout:ADD[:WINDow]?` on page 351)

```
CALC:FORM FREQ
```

to define the result type (see `CALCulate<n>:FORMat` on page 357)

```
TRAC:DATA TRACE1
```

to query the trace results (see `TRACe<n>[:DATA]` on page 363)

### 3.2.6 Frequency Relative

The instantaneous frequency of the signal source.

The results are normalized to the symbol rate (PSK and QAM modulated signals), the estimated FSK deviation (FSK modulated signals) or one quarter of the symbol rate (MSK modulated signals).

$$FREQ_{MEAS}(t) = \frac{1}{2 \cdot \pi} \frac{d}{dt} \angle MEAS(t)$$

with  $t=n \cdot T_D$  and  $T_D$ =the duration of one sampling period at the sample rate defined by the display points per symbol parameter (see "Display Points/Sym" on page 198).



This measurement is mainly of interest when using the MSK or FSK modulation, but can also be used for the PSK/QAM modulations. See also the note for [chapter 3.2.5, "Frequency Absolute"](#), on page 24.

Available for source types:

- Meas & Ref Signal

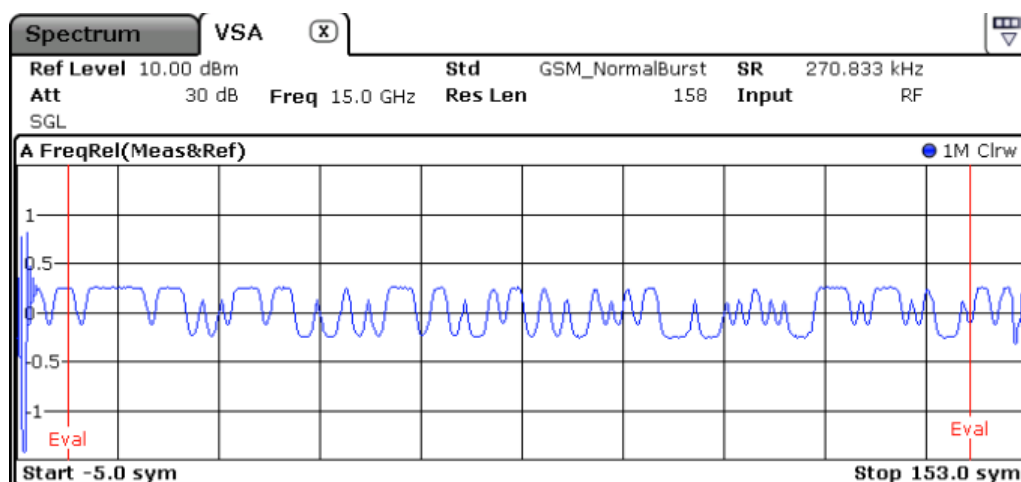


Fig. 3-7: Result display "Frequency Relative" in normal mode

#### SCPI commands:

```
LAY:ADD? '1',BEL,MEAS
```

to define the required source type (see [LAYout:ADD\[:WINDOW\]?](#) on page 351)

```
CALC:FORM FREQ
```

to define the result type (see [CALCulate<n>:FORMat](#) on page 357)

```
DISP:TRAC:Y:MODE REL
```

to define relative values (see [DISPlay\[:WINDOW<n>\]:TRACe:Y\[:SCALE\]:MODE](#) on page 360)

```
TRAC:DATA TRACE1
```

to query the trace results (see [TRACe<n>\[:DATA\]](#) on page 363)

### 3.2.7 Real/Imag (I/Q)

Real and imaginary part of the measurement or reference signal in separate measurement diagrams; the x-axis (scaled in time units or symbols) is identical for both diagrams

The scaling of the capture buffer is

- relative to the current reference level if you are using the RF input
- relative to the full scale level if you are using the I/Q input

Available for source types:

- Capture Buffer
- Meas & Ref Signal
- Error Vector

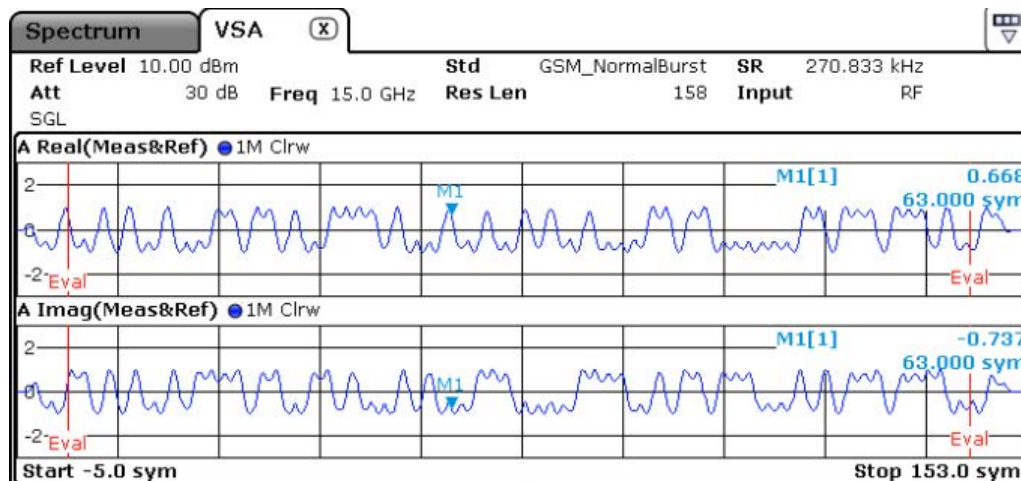


Fig. 3-8: Result display "Real/Imag (I/Q)" in normal mode

#### SCPI commands:

```
LAY:ADD? '1',BEL,MEAS
```

to define the required source type (see [LAYout:ADD\[:WINDow\]?](#) on page 351)

```
CALC:FORM RIMag
```

to define the result type (see [CALCulate<n>:FORMat](#) on page 357)

```
TRAC:DATA TRACE1
```

to query the trace results (see [TRACe<n>\[:DATA\]](#) on page 363)

### 3.2.8 Eye Diagram Real (I)

The eye pattern of the inphase (I) channel; the x-axis value range is from -1 to +1 symbols (MSK: -2 to +2)

Available for source types:

- Meas & Ref Signal

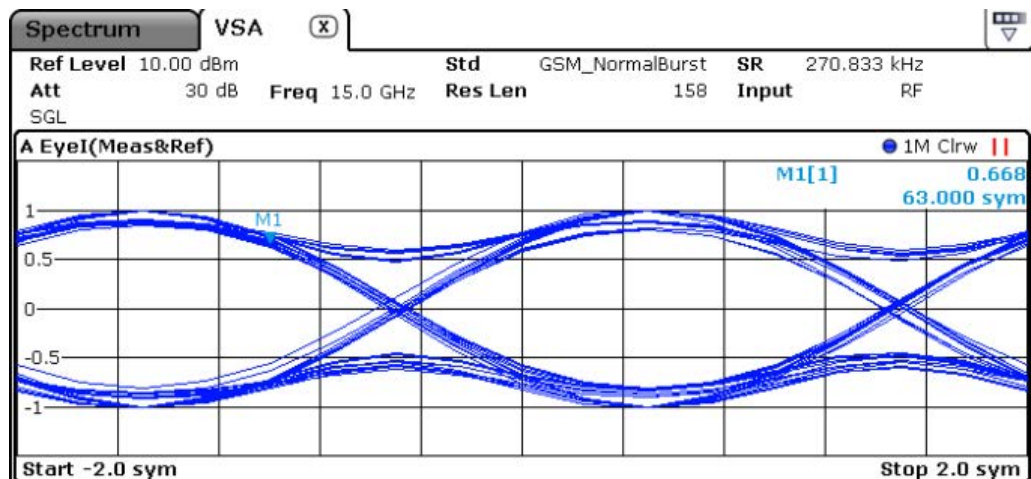


Fig. 3-9: Result display "Eye Diagram Real (I)" in normal mode

#### SCPI commands:

```
LAY:ADD? '1',BEL,MEAS
```

to define the required source type (see [LAYout:ADD\[:WINDow\]?](#) on page 351)

```
CALC:FORM IEYE
```

to define the result type (see [CALCulate<n>:FORMat](#) on page 357)

```
TRAC:DATA TRACE1
```

to query the trace results (see [TRACe<n>\[:DATA\]](#) on page 363)

### 3.2.9 Eye Diagram Imag (Q)

The eye pattern of the quadrature (Q) channel; the x-axis range is from -1 to +1 symbols (MSK: -2 to +2)

Available for source types:

- Meas & Ref Signal

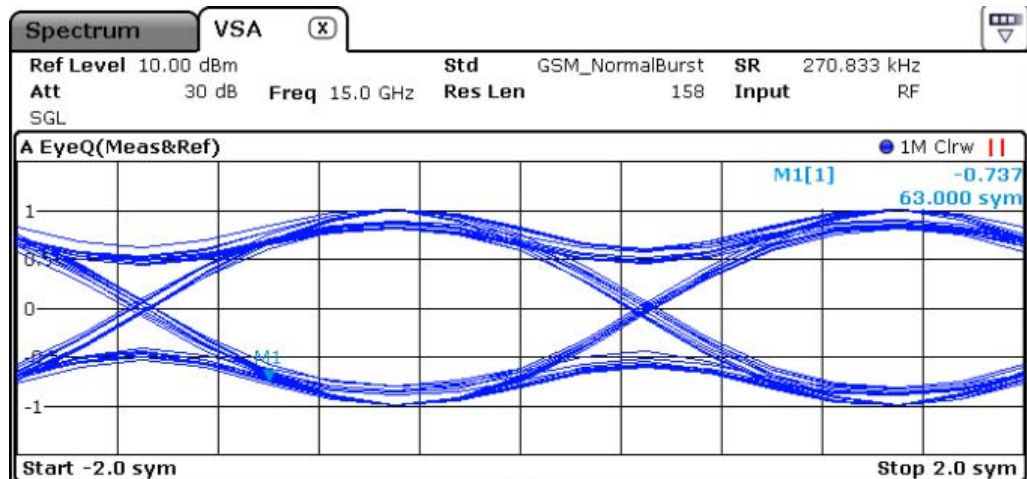


Fig. 3-10: Result display "Eye Diagram Imag (Q)" in normal mode

#### SCPI commands:

```
LAY:ADD? '1',BEL,MEAS
```

to define the required source type (see [LAYout:ADD\[:WINDow\]?](#) on page 351)

```
CALC:FORM QEYE
```

to define the result type (see [CALCulate<n>:FORMat](#) on page 357)

```
TRAC:DATA TRACE1
```

to query the trace results (see [TRACe<n>\[:DATA\]](#) on page 363)

### 3.2.10 Eye Diagram Frequency

The eye diagram of the currently measured frequencies and/or the reference signal. The time span of the data depends on the evaluation range (capture buffer).

Available for source types:

- Meas & Ref Signal

#### SCPI commands:

```
LAY:ADD? '1',BEL,MEAS
```

to define the required source type (see [LAYout:ADD\[:WINDow\]?](#) on page 351)

```
CALC:FORM FEYE
```

to define the result type (see [CALCulate<n>:FORMat](#) on page 357)

```
TRAC:DATA TRACE1
```

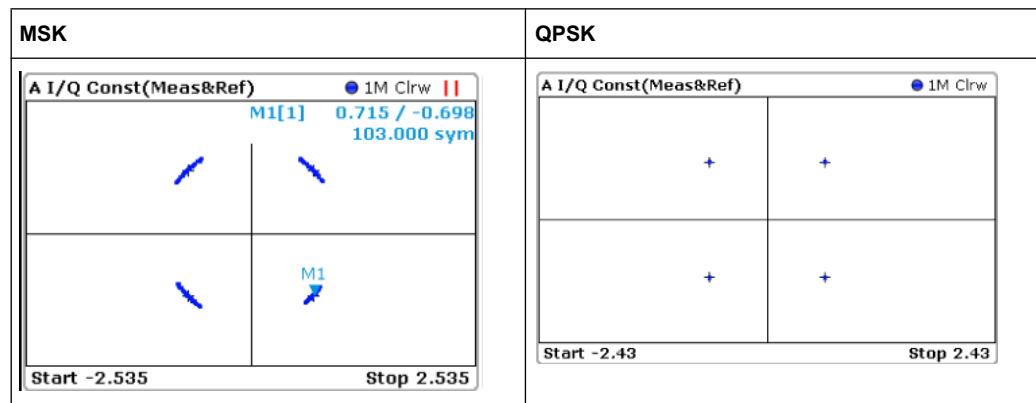
to query the trace results (see [TRACe<n>\[:DATA\]](#) on page 363)

### 3.2.11 Constellation I/Q

The complex source signal (without inter-symbol interference) as an X/Y plot; only the (de-rotated) symbol decision instants are drawn and not connected

Available for source types:

- Meas & Ref Signal



#### SCPI commands:

```
LAY:ADD? '1',BEL,MEAS
```

to define the required source type (see [LAYout:ADD\[:WINDow\]?](#) on page 351)

```
CALC:FORM CONS
```

to define the result type (see [CALCulate<n>:FORMat](#) on page 357)

```
TRAC:DATA TRACE1
```

to query the trace results (see [TRACe<n>\[:DATA\]](#) on page 363)

### 3.2.12 Constellation I/Q (Rotated)

The complex source signal as an X/Y plot; As opposed to the common Constellation I/Q display, the symbol decision instants, *including the rotated ones*, are drawn and not connected

Available for source types:

- Meas & Ref Signal  
This result type is only available for signals with a rotating modulation.

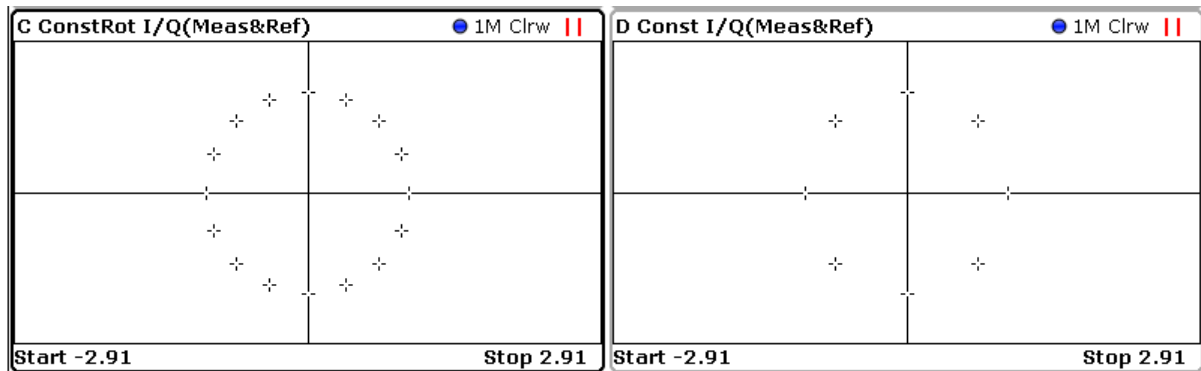


Fig. 3-11: Result display "Constellation I/Q (Rotated)" vs. common "Constellation I/Q" for 8PSK modulation

#### SCPI commands:

```
LAY:ADD? '1',BEL,MEAS
```

to define the required source type (see [LAYout:ADD\[:WINDow\]?](#) on page 351)

```
CALC:FORM RCON
```

to define the result type (see [CALCulate<n>:FORMat](#) on page 357)

```
TRAC:DATA TRACE1
```

to query the trace results (see [TRACe<n>\[:DATA\]](#) on page 363)

### 3.2.13 Vector I/Q

The complex source signal as an X/Y plot; all available samples (as defined by the display points per symbol parameter, see ["Display Points/Sym"](#) on page 198) are drawn and connected.

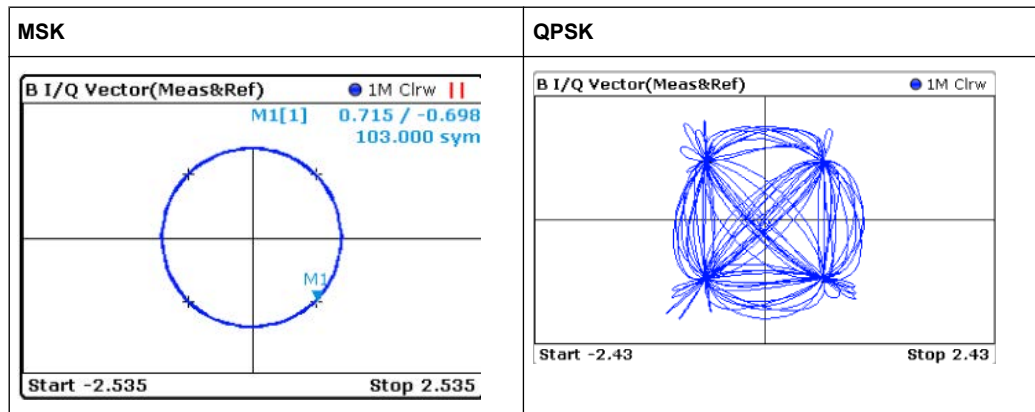


The scaling of the capture buffer is:

- relative to the current reference level if you are using the RF input
- relative to the full scale level if you are using the I/Q input

Available for source types:

- Capture Buffer
- Meas & Ref Signal
- Error Vector

**SCPI commands:**

```
LAY:ADD? '1',BEL,MEAS
```

to define the required source type (see [LAYout:ADD\[:WINDow\]?](#) on page 351)

```
CALC:FORM COMP
```

to define the result type (see [CALCulate<n>:FORMat](#) on page 357)

```
TRAC:DATA TRACE1
```

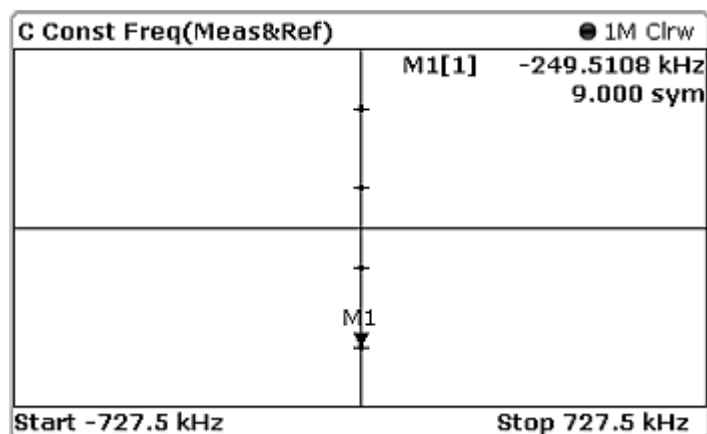
to query the trace results (see [TRACe<n>\[:DATA\]](#) on page 363)

**3.2.14 Constellation Frequency**

The instantaneous frequency of the source signal (without inter-symbol interference) as an X/Y plot; only the symbol decision instants are drawn and not connected.

Available for source types:

- Meas & Ref Signal

**SCPI commands:**

```
LAY:ADD? '1',BEL,MEAS
```



to define the required source type (see [LAYout:ADD\[:WINDow\]?](#) on page 351)

```
CALC:FORM CONF
```

to define the result type (see [CALCulate<n>:FORMat](#) on page 357)

```
TRAC:DATA TRACE1
```

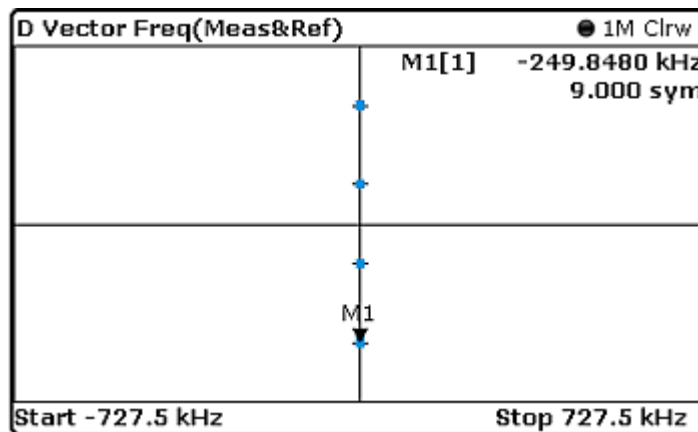
to query the trace results (see [TRACe<n>\[:DATA\]](#) on page 363)

### 3.2.15 Vector Frequency

The instantaneous frequency of the source signal as an X/Y plot; all available samples (as defined by the display points per symbol parameter (see ["Display Points/Sym"](#) on page 198)) are drawn and connected.

Available for source types:

- Meas & Ref Signal



#### SCPI commands:

```
LAY:ADD? '1',BEL,MEAS
```

to define the required source type (see [LAYout:ADD\[:WINDow\]?](#) on page 351)

```
CALC:FORM COVF
```

to define the result type (see [CALCulate<n>:FORMat](#) on page 357)

```
TRAC:DATA TRACE1
```

to query the trace results (see [TRACe<n>\[:DATA\]](#) on page 363)

### 3.2.16 Symbol Table

Symbol numbers are displayed as a table. Each symbol is represented by an entry in the table. The symbols can be displayed in binary, octal, hexadecimal or decimal format.

**Example:**

A Symbol Table (Binary)																									
	+	1	+	3	+	5	+	7	+	9	+	11	+	13	+	15	+	17	+	19	+	21	+	23	+
0	01	01	00	01	00	10	00	01	10	01	11	00	00	10	11	11	01	10	11	00	11	01	00	00	11
25	10	11	11	00	00	11	11	11	11	10	00	00	11	11	01	11	11	00	01	01	11	00	11	00	10
50	00	00	10	01	01	00	11	10	11	01	00	01	11	10	01	11	11	00	11	01	10	00	10	10	10
75	01	00	01	11	00	01	10	11	01	01	01	11	00	01	00	11	00	01	00	01	00	00	00	00	10

**Fig. 3-12: Result display for "Symbols" in binary mode**

If a pattern search is active, a found pattern is indicated in the symbol table, as well.

**SCPI commands:**

```
LAY:ADD? '1',BEL, 'XTIM:DDEM:SYMB'
```

to define the required source type (see [LAYout:ADD\[:WINDow\]?](#) on page 351)

```
TRAC:DATA TRACE1
```

to query the trace results (see [TRACe<n>\[:DATA\]](#) on page 363)

**3.2.17 Error Vector Magnitude (EVM)**

Displays the error vector magnitude as a function of symbols or time.

$$EVM(t) = \frac{|EV(t)|}{C}$$

with  $t = n \cdot T_D$  and  $T_D$  = the duration of one sampling period at the sample rate defined by the display points per symbol parameter (see ["Display Points/Sym"](#) on page 198).

The normalization constant  $C$  is chosen according to the EVM normalization. By default  $C^2$  is the mean power of the reference signal.

$$C = \sqrt{\frac{1}{K} \sum_k |REF(k \cdot T)|^2}$$

and

$T$  = duration of symbol periods

Note that  $k = 0.5 \cdot n \cdot T$  for Offset QPSK with inactive Offset EVM.

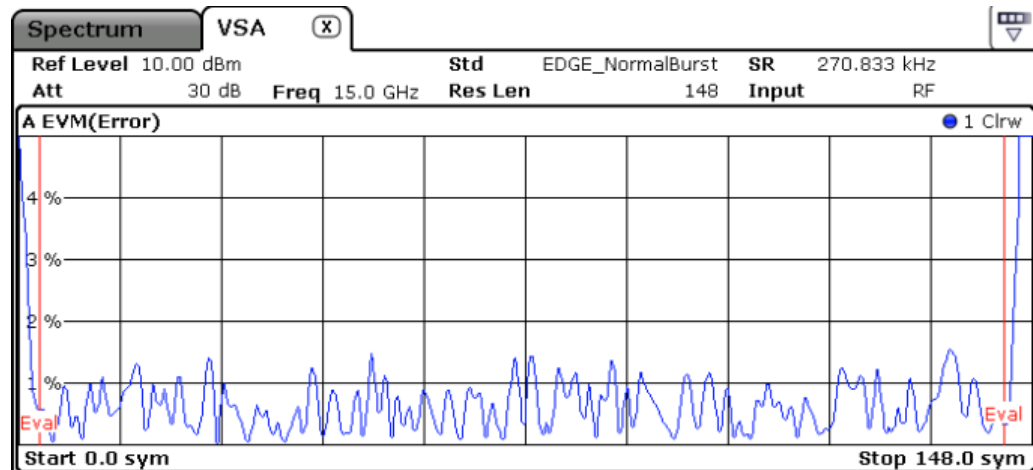


Fig. 3-13: Result display "Error Vector Magnitude" in normal mode

Available for source types:

- Error Vector

#### SCPI commands:

```
LAY:ADD? '1',BEL,EVEC
```

to define the required source type (see [LAYout:ADD\[:WINDow\]?](#) on page 351)

```
CALC:FORM MAGN
```

to define the result type (see [CALCulate<n>:FORMat](#) on page 357)

```
TRAC:DATA TRACE1
```

to query the trace results (see [TRACe<n>\[:DATA\]](#) on page 363)

### 3.2.18 Magnitude Error

Displays the magnitude error of the measurement signal with respect to the reference signal (as a function of symbols over time)

$$MAG\_ERR(t) = MAG_{MEAS}(t) - MAG_{REF}(t)$$

with  $t = n \cdot T_D$  and  $T_D$  = the duration of one sampling period at the sample rate defined by the display points per symbol parameter (see ["Display Points/Sym"](#) on page 198).

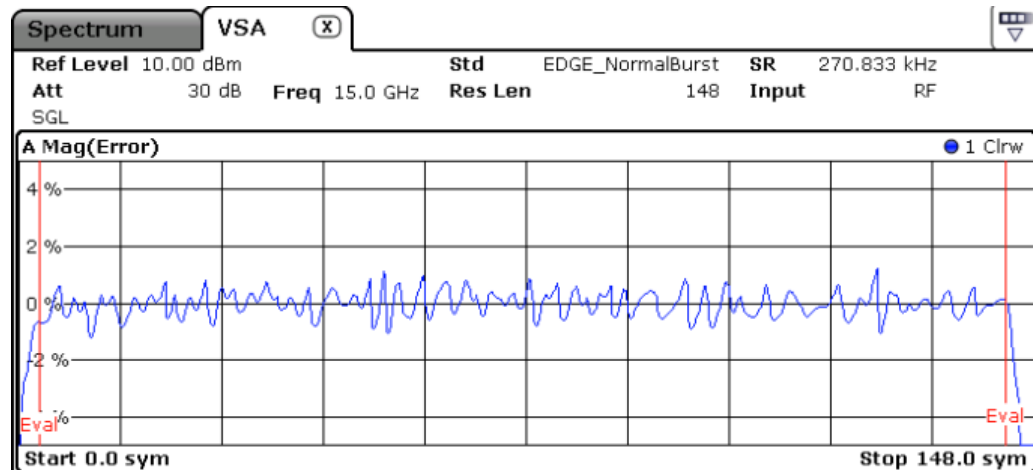


Fig. 3-14: Result display "Magnitude Error" in normal mode

Available for source types:

- Modulation Errors

#### SCPI commands:

```
LAY:ADD? '1',BEL,MERR
```

to define the required source type (see [LAYout:ADD\[:WINDow\]?](#) on page 351)

```
CALC:FORM MAGN
```

to define the result type (see [CALCulate<n>:FORMat](#) on page 357)

```
TRAC:DATA TRACE1
```

to query the trace results (see [TRACe<n>\[:DATA\]](#) on page 363)

### 3.2.19 Phase Error

Displays the phase error of the measurement signal with respect to the reference signal as a function of symbols over time.

$$PHASE\_ERR(t) = PHASE_{MEAS}(t) - PHASE_{REF}(t)$$

with  $t = n \cdot T_D$  and  $T_D$  = the duration of one sampling period at the sample rate defined by the display points per symbol parameter (see ["Display Points/Sym"](#) on page 198).

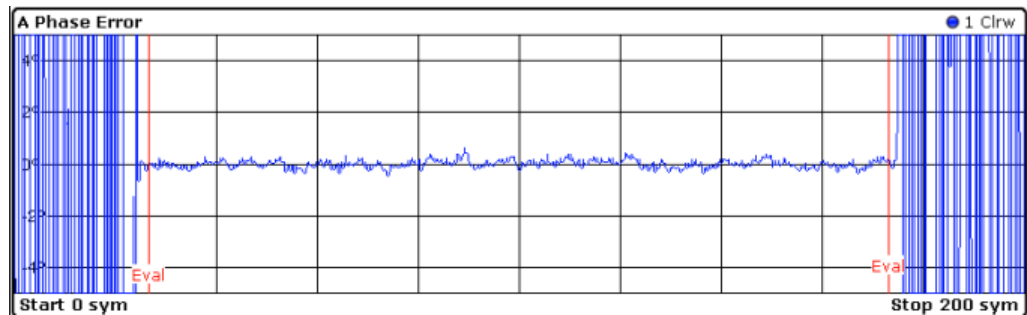


Fig. 3-15: Result display "Phase Error" in normal mode

Available for source types:

- Modulation Errors

#### SCPI commands:

```
LAY:ADD? '1',BEL,MERR
```

to define the required source type (see [LAYout:ADD\[:WINDow\]?](#) on page 351)

```
CALC:FORM PHAS
```

to define the result type (see [CALCulate<n>:FORMat](#) on page 357)

```
TRAC:DATA TRACE1
```

to query the trace results (see [TRACe<n>\[:DATA\]](#) on page 363)

### 3.2.20 Frequency Error Absolute

Displays the error of the instantaneous frequency in Hz of the measurement signal with respect to the reference signal as a function of symbols over time.

$$FREQ\_ERR(t) = FREQ_{MEAS}(t) - FREQ_{REF}(t)$$

with  $t = n \cdot T_D$  and  $T_D$  = the duration of one sampling period at the sample rate defined by the display points per symbol parameter (see "[Display Points/Sym](#)" on page 198).

Note that this measurement does not consider a possible carrier frequency offset. This has already been compensated for in the measurement signal.



This measurement is mainly of interest when using the MSK or FSK modulation, but can also be used for the PSK/QAM modulations. However, since these modulations can have transitions through zero in the I/Q plane, in this case you might notice uncritical spikes. This is due to the fact that the phase of zero (or a complex value close to zero) has in fact limited significance, but still influences the result of the current frequency measurement.

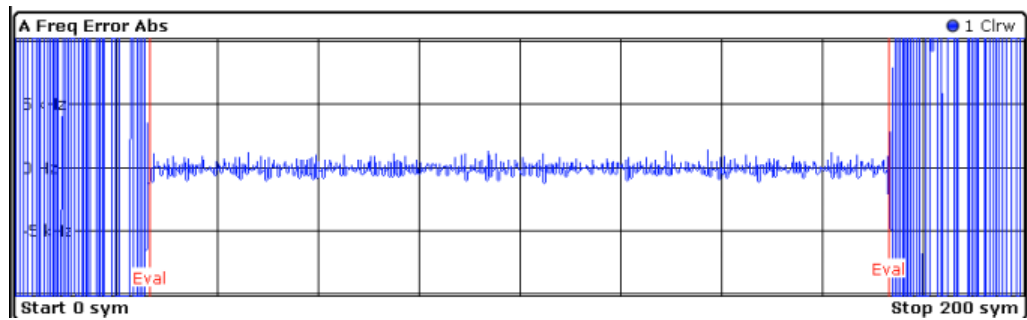


Fig. 3-16: Result display "Frequency Error Absolute" in normal mode

Available for source types:

- Modulation Errors

#### SCPI commands:

```
LAY:ADD? '1',BEL,MERR
```

to define the required source type (see [LAYout:ADD\[:WINDow\]?](#) on page 351)

```
CALC:FORM FREQ
```

to define the result type (see [CALCulate<n>:FORMat](#) on page 357)

```
TRAC:DATA TRACE1
```

to query the trace results (see [TRACe<n>\[:DATA\]](#) on page 363)

### 3.2.21 Frequency Error Relative

Displays the error of the instantaneous frequency of the measurement signal with respect to the reference signal as a function of symbols over time.

The results are normalized to the symbol rate (PSK and QAM modulated signals), the estimated FSK deviation (FSK modulated signals) or one quarter of the symbol rate (MSK modulated signals).

$$FREQ\_ERR(t) = FREQ_{MEAS}(t) - FREQ_{REF}(t)$$

with  $t = n \cdot T_D$  and  $T_D$  = the duration of one sampling period at the sample rate defined by the display points per symbol parameter (see ["Display Points/Sym"](#) on page 198).



This measurement is mainly of interest when using the MSK or FSK modulation, but can also be used for the PSK/QAM modulations. See also the note for [chapter 3.2.20, "Frequency Error Absolute"](#), on page 37.

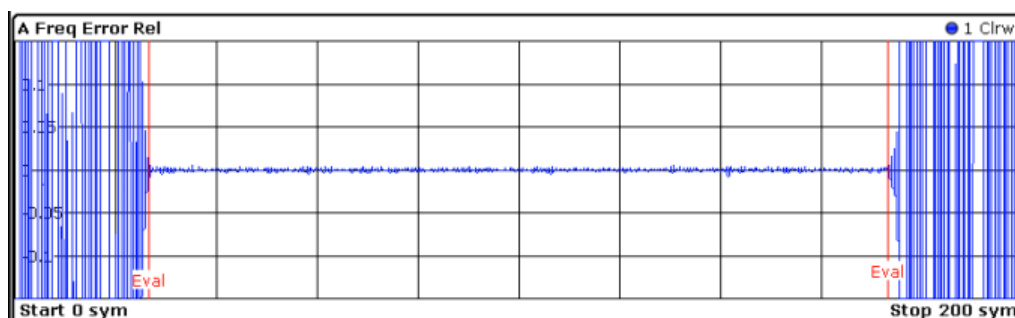


Fig. 3-17: Result display "Frequency Error Relative" in normal mode

Available for source types:

- Modulation Errors

#### SCPI commands:

```
LAY:ADD? '1',BEL,MERR
```

to define the required source type (see [LAYout:ADD\[:WINDow\]?](#) on page 351)

```
CALC:FORM FREQ
```

to define the result type (see [CALCulate<n>:FORMat](#) on page 357)

```
DISP:TRAC:Y:MODE REL
```

to define relative values (see [DISPlay\[:WINDow<n>\]:TRACe:Y\[:SCALE\]:MODE](#) on page 360)

```
TRAC:DATA TRACE1
```

to query the trace results (see [TRACe<n>\[:DATA\]](#) on page 363)

### 3.2.22 Result Summary

The Modulation Accuracy results in a table. For details on the parameters see [chapter 3.3, "Common Parameters in VSA"](#), on page 48.

#### Basis of evaluation

The majority of the values that are displayed in the Result Summary are calculated over the "Evaluation Range" (see [chapter 5.11, "Evaluation Range Configuration"](#), on page 181). They are evaluated according to the setting of the [Display Points/Sym](#) parameter. For example, if "Display Points/Symbol" is "1", only the symbol instants contribute to the result displayed in the result summary.

Table 3-2: Results calculated over the evaluation range

PSK, MSK, QAM	FSK
EVM	Frequency Error
MER	Magnitude Error

PSK, MSK, QAM	FSK
Phase Error	Power
Magnitude Error	
Rho	
Power	

The following results that are based on internal estimation algorithms (see [chapter 4.5, "Signal Model, Estimation and Modulation Errors"](#), on page 96) are calculated over the "Estimation range" (see also [chapter 4.5.1.2, "Estimation"](#), on page 97).

**Table 3-3: Results calculated over the estimation range**

PSK, MSK, QAM	FSK
Carrier Frequency Error	FSK Deviation Error
Symbol Rate Error	Symbol Rate Error
I/Q Offset	FSK Measurement Deviation
I/Q Imbalance	Carrier Frequency Error
Gain Imbalance	Carrier Frequency Drift
Quadrature Error	
Amplitude Droop	

### Current value

In the "Current" column, the value evaluation for the current evaluation is displayed. For example, the EVM Peak value in the current sweep corresponds to the peak of the trace values within the evaluation range for the current sweep (as indicated by marker 1 in [figure 3-18](#)).



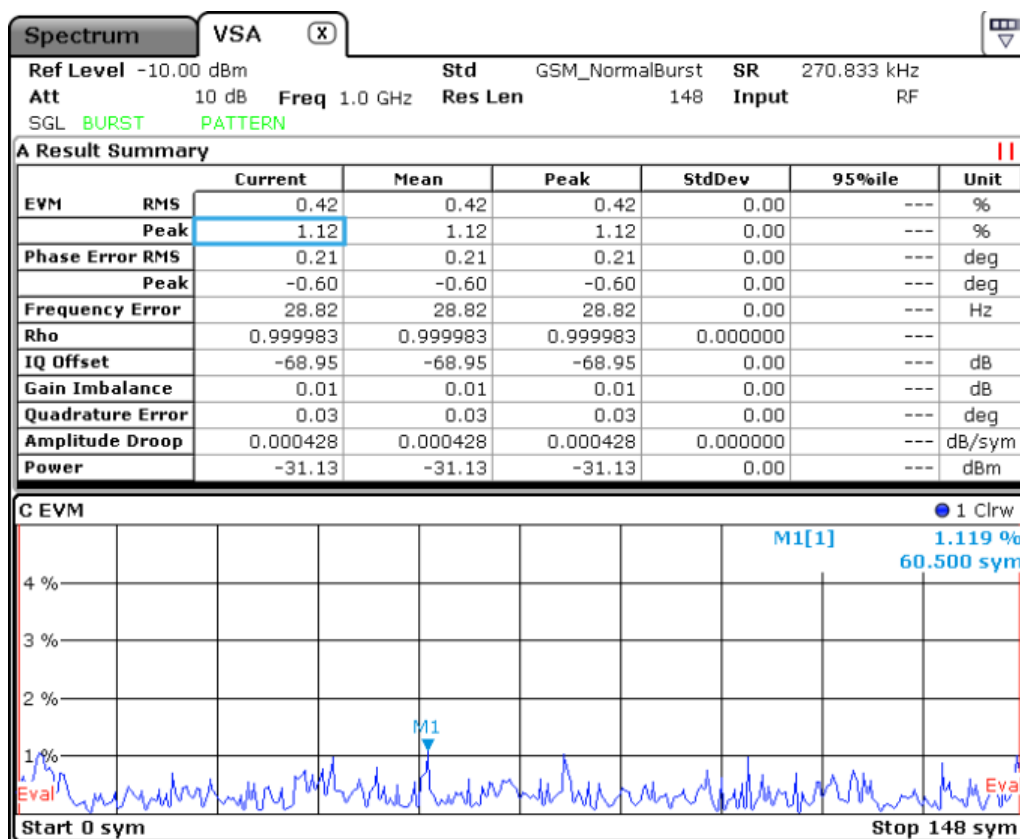


Fig. 3-18: Example for result summary with current EVM peak value marked

If you want to compare the trace values to the results of the Result Summary, make sure to match the displayed points per symbol of the trace and of the Result Summary. Refer to "Display Points/Sym" on page 198 for details.

### Mean value

In the "Mean" column, the linear mean of the values that are in the "Current" column is displayed. Note that if the values are in a logarithmic representation, e.g. the I/Q Offset, the linear values are averaged.

### Peak value

In the "Peak" column, the maximum value that occurred during several evaluations is displayed. Note that when the value can be positive and negative, e.g. the phase error, the maximum absolute value (maintaining its sign) is displayed. The peak value of Rho is handled differently, since its minimum value represents the worst case. In that case, the minimum value is displayed.

### Standard Deviation

The value for the standard deviation is calculated on the linear values and then converted to the displayed unit.

### 95-percentile

The 95-percentile value is based on the distribution of the current values. Since the phase error and the magnitude error can usually be assumed to be distributed around zero, the 95-Percentile for these values is calculated based on their absolute values. Again, the Rho value is handled differently. Here, the 5-Percentile is displayed, since the lowest Rho value represents the worst case.

#### SCPI commands:

```
LAY:ADD? '1',BEL, MACC
```

to define the required source type (see [LAYout:ADD\[:WINDow\]?](#) on page 351)

```
CALC:FORM RSUM
```

to define the result type (see [CALCulate<n>:FORMat](#) on page 357)

```
TRAC:DATA
```

to query the trace results (see [TRACe<n>\[:DATA\]](#) on page 363)

```
CALC:MARK:FUNC:DDEM:STAT:<parameter>
```

to query individual parameter values (see [chapter 10.8.2, "Retrieving Parameter Values"](#), on page 365)

### 3.2.23 Bit Error Rate (BER)

A bit error rate (BER) measurement compares the transmitted bits with the determined symbol decision bits:

BER = error bits / number of analyzed bits

As a prerequisite for this measurement, the VSA application must know which bit sequences are correct, i.e. which bit sequences may occur. This knowledge must be provided as a list of possible data sequences in xml format, which is loaded in the VSA application (see [chapter 4.8, "Known Data Files - Dependencies and Restrictions"](#), on page 116).

If such a file is loaded in the application, the BER result display is available.

Available for source types:

- Modulation Accuracy



Note that this measurement may take some time, as each symbol decision must be compared to the possible data sequences one by one.

The BER measurement is an indicator for the quality of the demodulated signal. High BER values indicate problems such as:

- inadequate demodulation settings
- poor quality in the source data
- false or missing sequences in the Known Data file
- result range alignment leads to a mismatch of the input data with the defined sequences

A BER value of 0.5 means that for at least one measurement no matching sequence was found.

See also [chapter 4.4.3, "Demodulation and Symbol Decisions"](#), on page 89

B Bit Error Rate				
	Current	Minimum	Maximum	Accumulative
Bit Error Rate	0.000 000 000	0.000 000 000	0.461 711 705	0.003 577 107
Total # of Errors	0	0	205	216
Total # of Bits	444	444	444	59940

The following information is provided in the BER result display:

- **Bit Error Rate:** error bits / number of analyzed bits
- **Total # of Errors:** number of detected bit errors (known data compared to symbol decisions)
- **Total # of Bits:** number of analyzed bits

For each of these results, the following values are provided:

BER Result	Description
Current	Value for current result range
Minimum	Minimum "Current" value during the current measurement
Maximum	Maximum "Current" value during the current measurement
Accumulative	Total value over several measurements; for BER: Total # of Errors / Total # of Bits (similar to average function)

#### SCPI commands:

```
LAY:ADD? '1',BEL,MACC
```

to define the required source type (see [LAYout:ADD\[:WINDow\]?](#) on page 351)

```
CALC:FORM BER
```

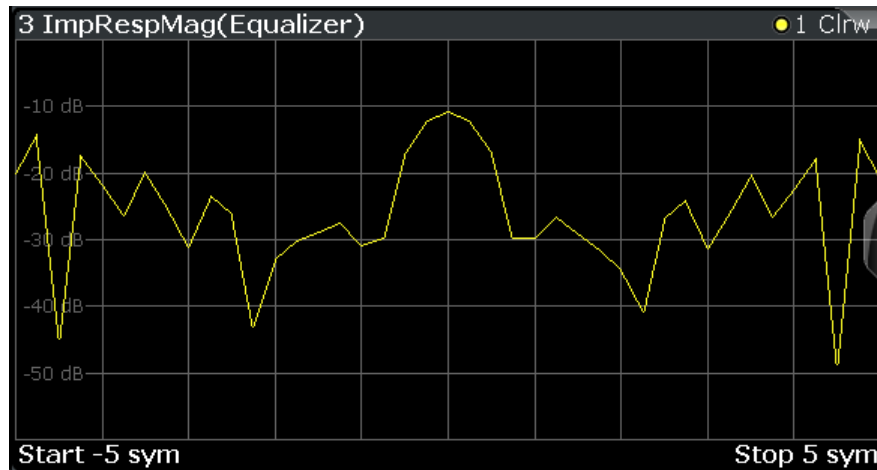
to define the result type (see [CALCulate<n>:FORMat](#) on page 357)

```
CALC:BER?
```

to query the results (see [CALCulate<n>:BERate](#) on page 365)

### 3.2.24 Impulse Response Magnitude

The impulse response magnitude of the equalizer shows the filter in the time domain.



#### SCPI commands:

```
LAY:ADD? '1',BEL,EQU
```

to define the required source type (see [LAYout:ADD\[:WINDow\]?](#) on page 351)

```
CALC:FORM MAGN
```

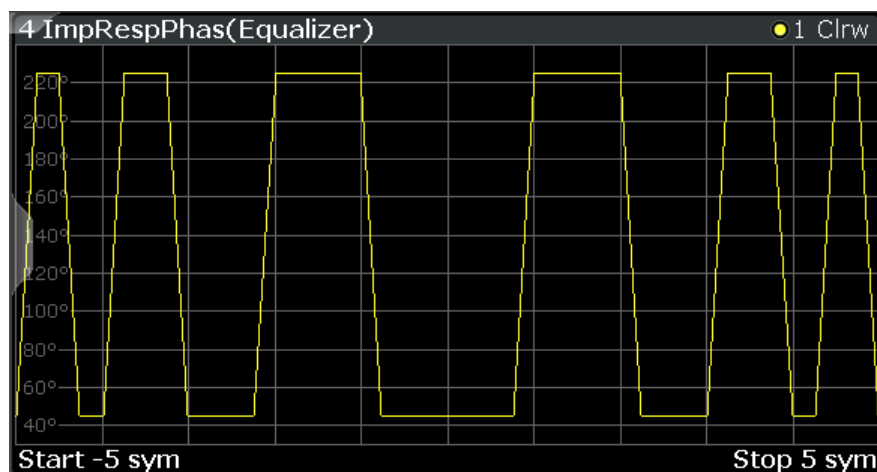
to define the result type (see [CALCulate<n>:FORMat](#) on page 357)

```
TRAC:DATA TRACE1
```

to query the trace results (see [TRACe<n>\[:DATA\]](#) on page 363)

### 3.2.25 Impulse Response Phase

The Impulse Response Phase is the derivation of the Impulse Response Magnitude.



**SCPI commands:**

```
LAY:ADD? '1',BEL,EQU
```

to define the required source type (see [LAYout:ADD\[:WINDow\]?](#) on page 351)

```
CALC:FORM UPH
```

to define the result type (see [CALCulate<n>:FORMat](#) on page 357)

```
TRAC:DATA TRACE1
```

to query the trace results (see [TRACe<n>\[:DATA\]](#) on page 363)

**3.2.26 Impulse Response Real/Imag**

The Real/Imag diagram of the impulse response is a stem diagram. It displays the filter characteristics in the time domain for both the I and the Q branches individually. Using this information the equalizer is uniquely characterized and can be recreated by other applications.

**SCPI commands:**

```
LAY:ADD? '1',BEL,EQU
```

to define the required source type (see [LAYout:ADD\[:WINDow\]?](#) on page 351)

```
CALC:FORM RIM
```

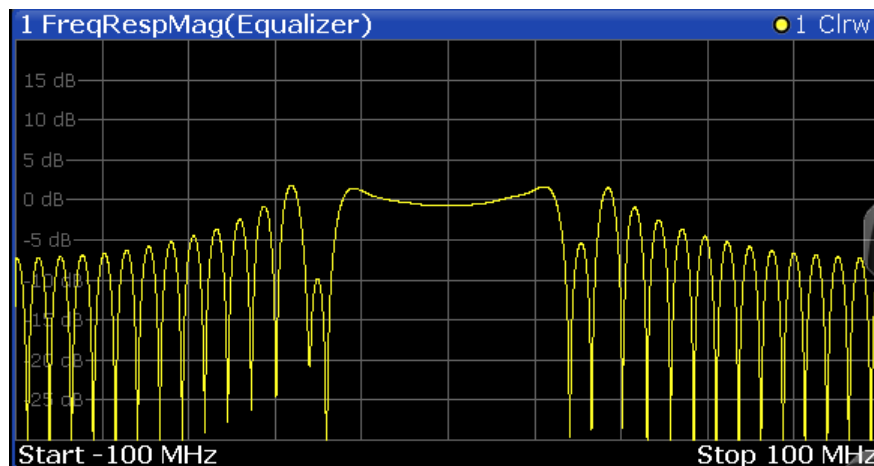
to define the result type (see [CALCulate<n>:FORMat](#) on page 357)

```
TRAC:DATA TRACE1
```

to query the trace results (see [TRACe<n>\[:DATA\]](#) on page 363)

**3.2.27 Frequency Response Magnitude**

Frequency response of the current equalizer to the input signal. Note that the frequency response of the equalizer is not a pure inverted function of the channel response, as both functions are calculated independently. The frequency response is calculated by determining an optimal EVM for the input signal.

**SCPI commands:**

```
LAY:ADD? '1',BEL,EQU
```

to define the required source type (see [LAYout:ADD\[:WINDow\]?](#) on page 351)

```
CALC:FORM MAGN
```

to define the result type (see [CALCulate<n>:FORMat](#) on page 357)

```
TRAC:DATA TRACE1
```

to query the trace results (see [TRACe<n>\[:DATA\]](#) on page 363)

**3.2.28 Frequency Response Phase**

The frequency response phase of the equalizer is derived from the Frequency Response Magnitude.

**SCPI commands:**

```
LAY:ADD? '1',BEL,EQU
```

to define the required source type (see [LAYout:ADD\[:WINDow\]?](#) on page 351)

```
CALC:FORM UPH
```

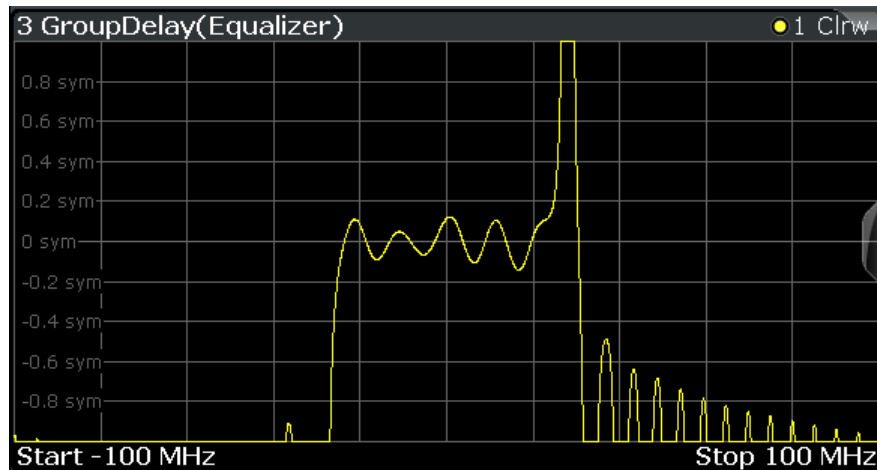
to define the result type (see [CALCulate<n>:FORMat](#) on page 357)

```
TRAC:DATA TRACE1
```

to query the trace results (see [TRACe<n>\[:DATA\]](#) on page 363)

**3.2.29 Group Delay**

The group delay of the equalizer is the derivation of phase over frequency. It is a measure of phase distortion.

**SCPI commands:**

```
LAY:ADD? '1',BEL,EQU
```

to define the required source type (see [LAYout:ADD\[:WINDow\]?](#) on page 351)

```
CALC:FORM GDEL
```

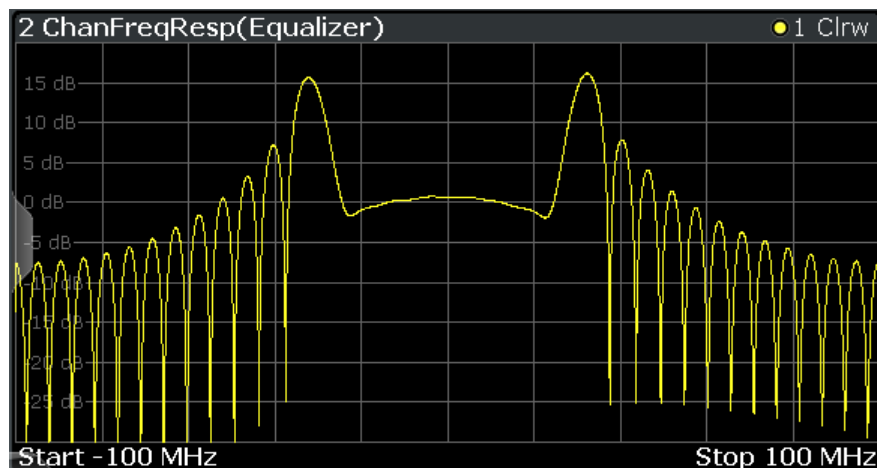
to define the result type (see [CALCulate<n>:FORMat](#) on page 357)

```
TRAC:DATA TRACE1
```

to query the trace results (see [TRACe<n>\[:DATA\]](#) on page 363)

**3.2.30 Channel Frequency Response Magnitude**

The frequency response magnitude of the channel indicates which distortions occurred during transmission of the input signal. It is only determined if the equalizer is activated.



The bandwidth for which the channel transfer function can be estimated is not only limited by the usable I/Q bandwidth, but also by the bandwidth of the analyzed input signal. Areas with low reception power, e.g. at the filter edges, may suffer from less accurate estimation results.

**SCPI commands:**

```
LAY:ADD? '1',BEL,EQU
```

to define the required source type (see [LAYout:ADD\[:WINDow\]?](#) on page 351)

```
CALC:FORM MAGN
```

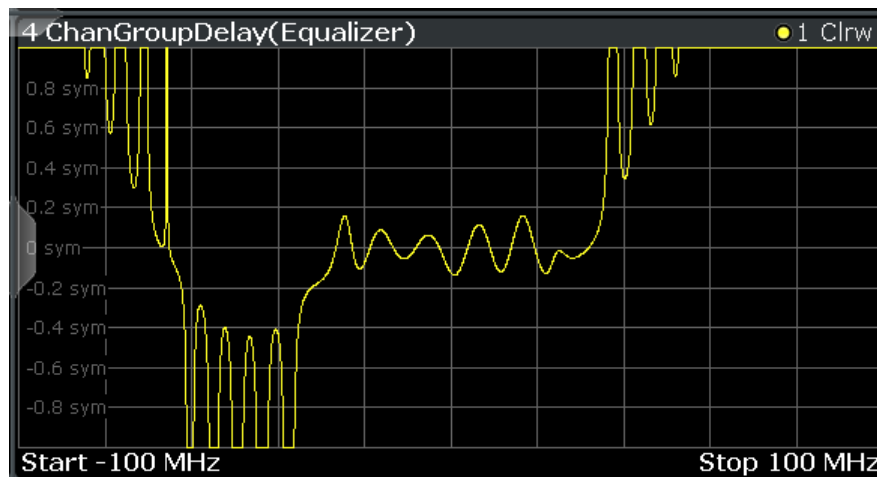
to define the result type (see [CALCulate<n>:FORMat](#) on page 357)

```
TRAC:DATA TRACE1
```

to query the trace results (see [TRACe<n>\[:DATA\]](#) on page 363)

**3.2.31 Channel Group Delay**

The group delay of the channel is the derivation of phase over frequency for the original input signal. It is a measure of phase distortion.

**SCPI commands:**

```
LAY:ADD? '1',BEL,EQU
```

to define the required source type (see [LAYout:ADD\[:WINDow\]?](#) on page 351)

```
CALC:FORM GDEL
```

to define the result type (see [CALCulate<n>:FORMat](#) on page 357)

```
TRAC:DATA TRACE1
```

to query the trace results (see [TRACe<n>\[:DATA\]](#) on page 363)

**3.3 Common Parameters in VSA**

Depending on the modulation type you are using, different signal parameters are determined during vector signal analysis.



Details concerning the calculation of individual parameters can be found in [chapter 4.5, "Signal Model, Estimation and Modulation Errors"](#), on page 96 and [chapter A.5, "Formulae"](#), on page 410.

**Table 3-4: Parameters for PSK, QAM and MSK modulation**

Parameter	Description	SCPI Parameter
EVM - RMS/Peak	Error Vector Magnitude	EVM
MER - RMS/Peak	Modulation Error Ratio	SNR
Phase Error - RMS/Peak	The phase difference between the measurement vector and the reference vector	PERR
Magnitude Error - RMS/Peak	The average (RMS) and peak magnitude error in %. The magnitude error is the difference of the measured magnitude to the magnitude of the reference signal. The magnitude error is normalized to the mean magnitude of the reference signal.	MERRor
Carrier Frequency Error	The mean carrier frequency offset in Hz	CFERror
Symbol Rate Error		SRER
Rho		RHO
I/Q Offset	Offset in the original input	OOffset
I/Q Imbalance	Not for BPSK.	IQIMbalance
Gain Imbalance	Not for BPSK.	GIMBalance
Quadrature Error	Not for BPSK.	QERRor
Amplitude Droop	The decrease of the signal power over time in the transmitter	ADRoop
Power	The power of the measured signal	MPOWer

**Table 3-5: Parameters for FSK modulation only**

Parameter	Description	SCPI parameter
Frequency Error - RMS/Peak	The average (RMS) and peak frequency error in %. The frequency error is the difference of the measured frequency and the reference frequency. The frequency error is normalized to the estimated FSK deviation.	FSK:DERRor
FSK Deviation Error	The deviation error of FSK modulated signals in Hz. The FSK deviation error is the difference of the FSK deviation of the measured signal and the FSK reference deviation you have set.	FDERRor
FSK Meas Deviation	The estimated deviation of FSK modulated signals in Hz.	FSK:MDEViation
FSK Ref Deviation	The reference deviation you have set in Hz.	FSK:RDEViation
Carrier Frequency Drift	The mean carrier frequency drift in Hz per symbol.	FSK:CFDRift

**SCPI command:**

CALCulate<n>:MARKer<m>:FUNCTion:DDEMod:STATistic:<Parameter>?

## 4 Measurement Basics

Some background knowledge on basic terms and principles used in VSA is provided here for a better understanding of the required configuration settings.

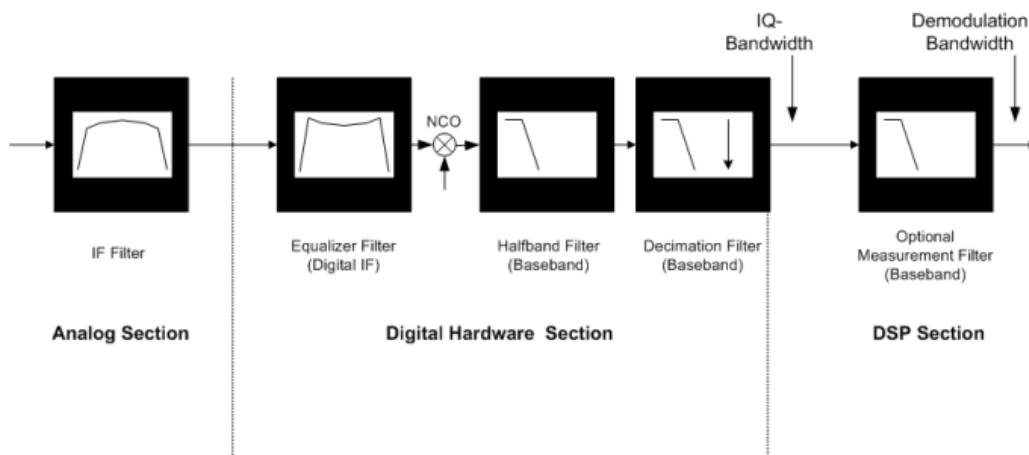
For information on the basic processing of I/Q data in the R&S FSW see the R&S FSW I/Q Analyzer User Manual.

- [Filters and Bandwidths During Signal Processing](#).....50
- [Sample Rate, Symbol Rate and I/Q Bandwidth](#).....57
- [Symbol Mapping](#).....63
- [Overview of the Demodulation Process](#).....84
- [Signal Model, Estimation and Modulation Errors](#).....96
- [Measurement Ranges](#).....111
- [Display Points vs Estimation Points per Symbol](#).....115
- [Known Data Files - Dependencies and Restrictions](#).....116
- [VSA in MSRA Operating Mode](#).....118

### 4.1 Filters and Bandwidths During Signal Processing

This section describes the used filters in vector signal analysis with an R&S FSW, as well as the bandwidth after each filter.

The relevant filters for vector signal analysis are shown in [figure 4-1](#).



**Fig. 4-1: Block diagram of bandwidth-relevant filters for vector signal analysis**

- After the IF Filter (only for RF input operation): bandwidth = 40 MHz
- After the digital hardware section:  
The phase and amplitude distortions of the IF filter have been compensated for.  
Usually, the I/Q data has a usable bandwidth of about:  
 $0.8 \cdot \text{sample rate}$   
For details refer to [chapter 4.1.1, "I/Q Bandwidth"](#), on page 51.  
The I/Q data's sample rate and bandwidth are automatically adjusted to the set symbol rate. For most modulated signals even the smallest allowed value for the sample

rate leads to a sufficient I/Q data bandwidth. The whole spectrum of the input signal is captured, but most adjacent channels and interferers are effectively suppressed. Only for very wide signals (FSK, no TX-filter used) it can be necessary to try higher values for the sample rate (see [chapter 4.2, "Sample Rate, Symbol Rate and I/Q Bandwidth"](#), on page 57), increasing the I/Q bandwidth. The I/Q data delivered to the DSP section has no considerable amplitude or phase distortion and a suitable bandwidth.



The "Signal Capture" dialog box ("Data Acquisition" tab) shows the sample rate and the usable I/Q bandwidth achieved for the current settings (see ["Usable I/Q Bandwidth"](#) on page 153).

- After the optional measurement filter:  
The measurement signal and the reference signal can be filtered by various measurement filters which have different bandwidths.

The filters described above are the ones that directly affect the bandwidth of the captured I/Q data and the final measurement signal and reference signal. Note, however, that several other filters are also involved in the DSP section but are not mentioned above:

- Receive filter to prevent ISI (intersymbol-interference)
- filters necessary for various estimators
- others

#### 4.1.1 I/Q Bandwidth

The bandwidth of the I/Q data used as input for the vector signal analysis is filtered as described in [chapter 4.1, "Filters and Bandwidths During Signal Processing"](#), on page 50. Its flat, usable bandwidth (no considerable amplitude or phase distortion) depends on:

- the used sample rate, which depends on:
  - the defined "Symbol Rate" (see ["Symbol Rate"](#) on page 129)
  - the defined "Sample Rate" parameter (see ["Sample Rate"](#) on page 153)
- the type of input used (digital baseband input, RF input, etc)

For details on the maximum usable bandwidth see [chapter 4.2, "Sample Rate, Symbol Rate and I/Q Bandwidth"](#), on page 57.



The sample rate and the usable I/Q bandwidth achieved for the current settings is displayed in the "Signal Capture" dialog, see [chapter 5.6.1, "Data Acquisition"](#), on page 151.

#### 4.1.2 Demodulation Bandwidth (Measurement Bandwidth)

Some modulation systems do not use a receive filter. In these cases special care should be taken that no interference or adjacent channels occur within the demodulation band-

width. The "Sample rate" parameter should be set to a low value (see "Sample Rate" on page 153).



Typical communication systems demand special receive or measurement filters (e.g. root-raised cosine receive filter or EDGE measurement filter).

If no such filtering is performed, care should be taken that neither interfering signals nor adjacent channels fall within the demodulation bandwidth.

### 4.1.3 Modulation and Demodulation Filters

Sample points are required for demodulation in the analyzer, where only information of the current symbol and none of neighbouring symbols is present (symbol points). These points are also called ISI-free points (ISI = intersymbol interference). If the transmitter does not provide an ISI-free signal after the transmit filter (**TX filter**), this condition can be fulfilled by signal-specific filtering of the analyzer input signal (**receive filter** or **Rx filter**). If an RRC (root-raised cosine) filter is used in the transmitter, an RRC filter is also required in the analyzer to obtain ISI-free points.

In many PSK systems, RRC filters are used as transmit, ISI and measurement filters. To determine the I/Q modulation error, the measurement signal must be compared with the corresponding ideal signal. For this purpose a **reference filter** is required which is calculated by the analyzer by convolving the coefficient of the transmit filter (**Tx filter**) and the **meas filter** (see [figure 4-2](#)).

If unfiltered signals have to be measured as well (e.g. to determine nonlinear signal distortions), no measurement filter is switched into the signal path and the **reference filter** is identical to the **Transmit filter** (see [figure 4-2](#)).

In the baseband block diagrams (see [figure 4-2](#)), the system-theoretical transmitter and analyzer filters are shown for PSK and QAM demodulation. For the sake of clearness, RF stages, IF filters and the filter stages of the **digital hardware section** are not shown.

For a correct demodulation, the following filters have to be accurately specified for the analyzer:

- Transmit filter: filter characteristic of transmitter
- Meas filter:
  - PSK, QAM, UserQAM, MSK:  
The I and the Q part of the measurement and the reference signal are filtered with this filter.
  - FSK:  
The instantaneous frequency of the measurement reference signal are filtered.

In many applications, the measurement filter is identical with the ISI filter.

The receive filter (ISI filter) is configured internally depending on the transmit filter. The goal is to produce intersymbol-interference-free points for the demodulation.

The reference filter synthesizes the ideal transmitted signal (after meas filtering). It is calculated by the analyzer from the above filters (convolution operation **Transmit filter \* Meas Filter**).

Typical combinations of Tx and Meas filters are shown in [table 1-4](#); they can be set in the VSA application using "Meas filter = AUTO" (see "[Using the Transmit Filter as a Measurement Filter \(Auto\)](#)" on page 180). If RC (raised cosine), RRC (root-raised cosine) and Gaussian filters are used, the Alpha (RC, RRC filters) or BT (Gaussian filters) parameters must be set in addition to the filter characteristic (roll-off factor). Typically the Alpha/BT value of the measurement filter should be the same as that of the transmission filter.

#### 4.1.4 Measurement Filters

The measurement filter can be used to filter the following two signals in the same way:

- the measurement signal (after coarse frequency, phase and timing synchronization have been achieved)
- the reference signal, i.e the I/Q symbols that have been determined in the demodulator and have already been filtered with the Transmit filter;

For FSK, the measurement filter filters the instantaneous frequency of the signal, not the I/Q signal.

For MSK, PSK, QAM and User QAM the measurement filter filters the real part and imaginary part of these signals (i.e. not the instantaneous frequency or magnitude of the signal).

The VSA application defines the error signal as the difference between the reference signal and the measurement signal. Thus, the measurement filter also shapes the spectrum of the error signal, which is used to calculate the EVM, for example.

In many applications the measurement filter is the same as the RX filter. However, unlike the measurement filter, the RX filter is not relevant for the measurement, but is only required to create the reference signal optimally.

The RX filter and the transmit filter are usually chosen such that their combination results in an Inter-Symbol Interference (ISI) free system (see [figure 4-2](#) and [figure 4-3](#)).

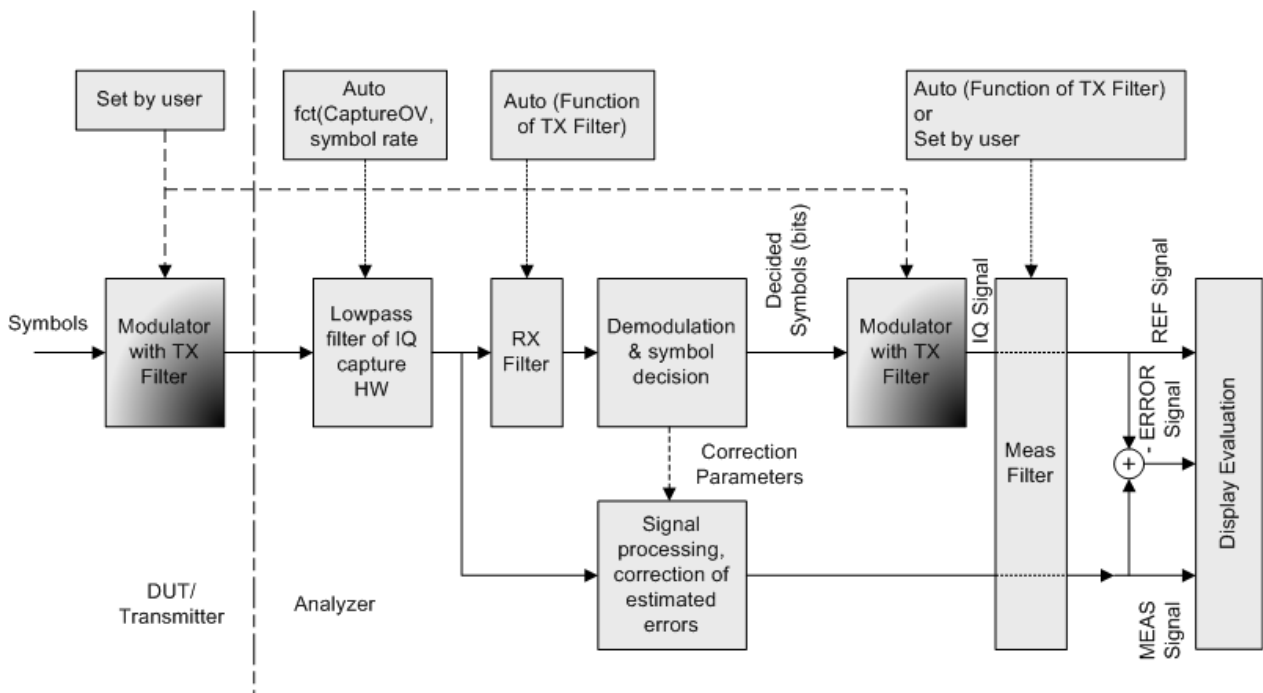


Fig. 4-2: Measurement filter in the block diagram (MSK, PSK, QAM and UserQAM)

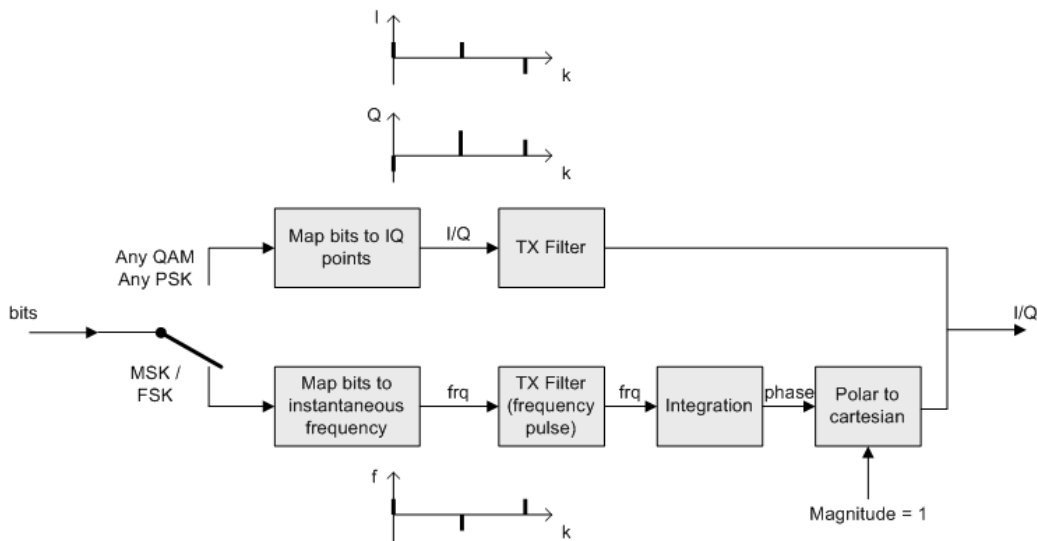


Fig. 4-3: Modulator with Transmit filter in detail

As the measurement filters of the VSA application have low-pass characteristics, they suppress high frequency distortion components in the Meas/Ref/Error signal. The errors are weighted spectrally. Thus, turning off the measurement filter can have an influence on the numeric and graphical error values. However, the measurement filter should be switched off if non-linear distortions have to be measured (they usually produce high frequency components).

### Predefined measurement filters

The most frequently required measurement filters are provided by the VSA application (see [chapter A.2.2, "Measurement Filters"](#), on page 404).

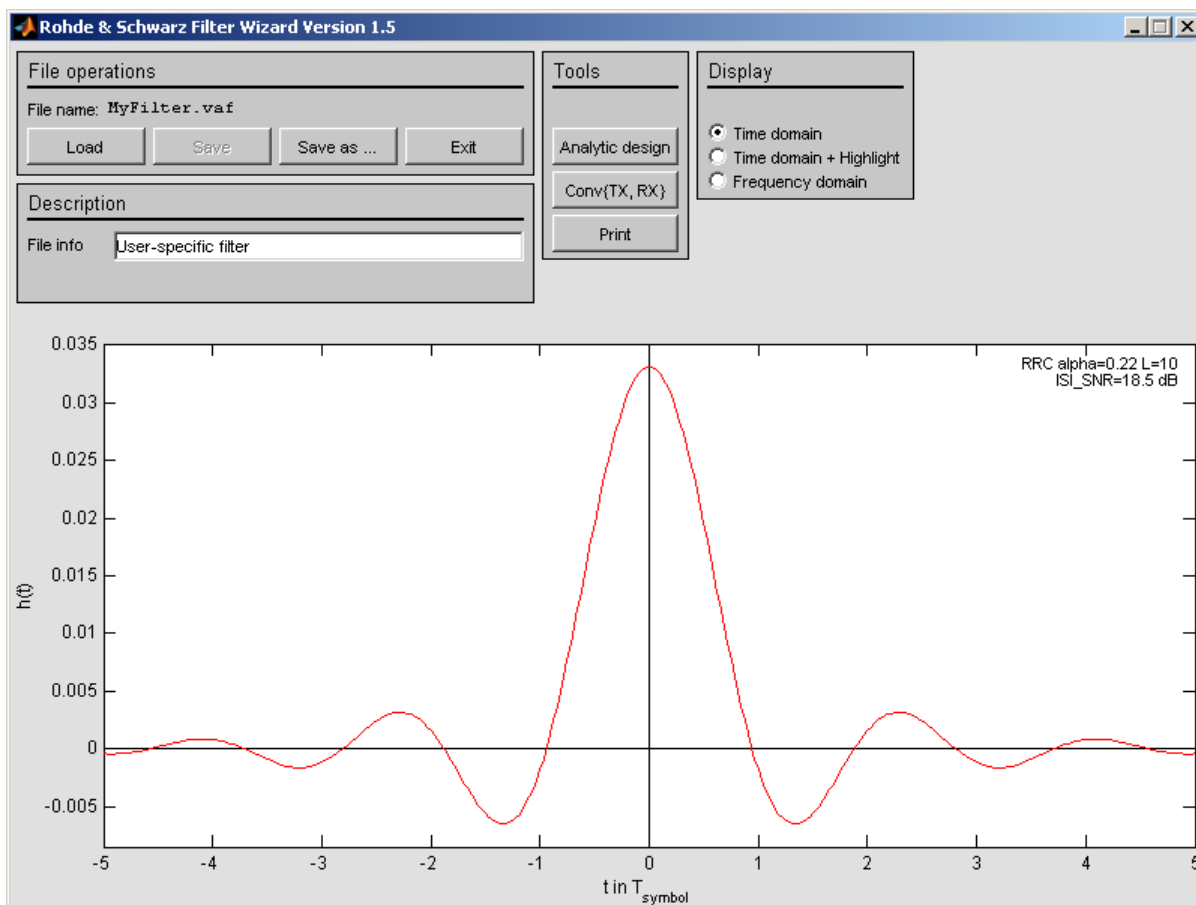
The frequency response of the available standard-specific measurement filters is shown in [chapter A.5.6.2, "Measurement Filter"](#), on page 418.

## 4.1.5 Customized Filters

The analytical filter types RC (raised cosine), RRC (root-raised cosine) and GAUSSIAN as well as the most important standard-specific filters are already integrated in the VSA application. In addition, it is possible to use user-defined measurement and transmit filters. Customized filters may be useful for the following purposes:

- Development of new networks and modulation methods for which no filters are defined yet.
- Measurements of transmitter characteristics with slightly modified (e.g. shortened) transmitter filters.

An external program ("FILTWIZ") is offered to convert user-defined filters. This program generates filter files (\*.vaf) which can be transferred to the analyzer with a USB device, for example. The program can be downloaded together with a detailed description as a precompiled MATLAB® file (MATLAB pcode) on the Internet, at <http://www.rohde-schwarz.com> (search term "FILTWIZ").



**Fig. 4-4: FILTWIZ - filter tool for VSA**

It is possible to load customized transmit filters and customized measurement filters. If a customized transmit filter is selected, the internal receive filter coefficients are calculated automatically on the fly.



Note that this is different to the R&S FSQ-K70, where it is necessary to also transfer a user receive filter.

If you upload a customized transmit filter and leave the measurement filter set to "automatic", the internally calculated receive filter will be used as measurement filter. Note that this filter is not necessarily suitable for your specific signal. The filter is optimized such that the intersymbol interference is low. Hence, you will probably be able to see a clear eye diagram and an Vector I/Q diagram with a recognizable constellation. However, a filter that has low intersymbol interference *might* lead to noise enhancement, which is commonly undesirable for a measurement filter. In order to avoid noise enhancement, it is recommended that you:

- a) design your own measurement filter and upload it as a user filter
- b) select a suitable measurement filter from the list



### Transferring filter files to the R&S FSW

You can transfer the (.vaf) filter files to the R&S FSW using a USB memory device.

## 4.2 Sample Rate, Symbol Rate and I/Q Bandwidth

The "Symbol Rate" defined in the "Signal Description" settings determines how many symbols are captured and demodulated during a certain measurement time. However, for each symbol more than one sample may be captured, so that the sample rate may be higher than the symbol rate.

The "Sample Rate" parameter in the "Data Acquisition" settings defines the **number of samples to capture per symbol** (not to be confused with the estimation points per symbol or display points per symbol, see [chapter 4.7, "Display Points vs Estimation Points per Symbol"](#), on page 115). The resulting sample rate (depending on the "Symbol Rate") is indicated behind the parameter.

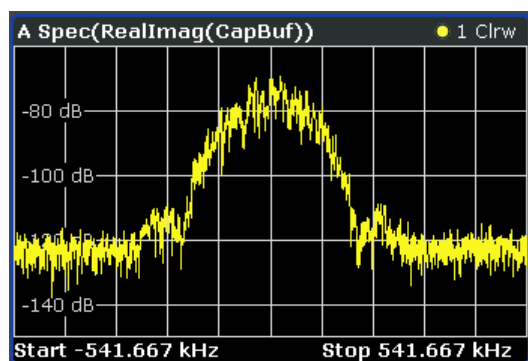


The number of samples to capture per symbol was referred to as the "**Capture Oversampling**" value in previous R&S signal and spectrum analyzers.

The resulting sample rate, also referred to as the user or output sample rate, is the rate at which the I/Q data is demodulated and analyzed. The sample rate also affects the demodulation (measurement) bandwidth (see also [chapter 4.2.1, "Sample Rate and Maximum Usable I/Q Bandwidth for RF Input"](#), on page 58). If the bandwidth is too narrow, the signal is not displayed completely. If the bandwidth is too wide, interference from outside the actual signal to be measured can distort the result. Thus, for signals with a large frequency spectrum (e.g. FSK modulated signals), a higher sample rate may be necessary.

(For further details, see [chapter 4.1, "Filters and Bandwidths During Signal Processing"](#), on page 50.)

For an indication of the required sample rate, view the "Real/Imag (I/Q)" display of the capture buffer with a "Spectrum" transformation. If the complete signal is displayed and fills the width of the display, the selected value is suitable.



*Fig. 4-5: Determining the I/Q bandwidth: Real/Imag (I/Q) display of the capture buffer with a spectrum transformation*

If the signal is cut off, increase the sample rate; if it is too small, decrease the sample rate (by changing the "Symbol Rate" defined in the "Signal Description" settings, or the "Sample Rate" parameter in the "Data Acquisition" settings).

As described above, the sample rate is determined by the number of samples to capture per symbol. Thus, the maximum sample rate depends on the maximum number of symbols to be captured (the **symbol rate**) and vice versa. The maximum sample rate for the R&S FSW is 10 GHz (see [chapter 4.2.1, "Sample Rate and Maximum Usable I/Q Bandwidth for RF Input"](#), on page 58). Thus, the maximum symbol rate is:

**Table 4-1: Maximum symbol rate depending on sample rate parameter**

Sample rate parameter	Max. symbol rate
4* symbol rate	2500 MSymbols
8* symbol rate	1250 MSymbols
16* symbol rate	625 MSymbols
32* symbol rate	312.5 MSymbols

#### 4.2.1 Sample Rate and Maximum Usable I/Q Bandwidth for RF Input

Within the usable I/Q bandwidth range, the analog IF filter of the R&S FSW is equalized in regard to amplitude characteristic and group delay (provided that the R&S FSW is aligned). In consequence, signals within this bandwidth range are hardly distorted at all (provided the R&S FSW is not overloaded).

For the I/Q data acquisition, digital decimation filters are used internally. The passband of these digital filters determines the *maximum usable I/Q bandwidth*. In consequence, signals within the usable I/Q bandwidth (passband) remain unchanged, while signals outside the usable I/Q bandwidth (passband) are suppressed. Usually, the suppressed signals are noise, artifacts, and the second IF side band. If frequencies of interest to you are also suppressed, you should try to increase the output sample rate, since this increases the maximum usable I/Q bandwidth.



#### Bandwidth extension options

The maximum usable I/Q bandwidth provided by the R&S FSW in the basic installation can be extended by additional options. These options can either be included in the initial installation (B-options) or updated later (U-options). The maximum bandwidth provided by the individual option is indicated by its number, e.g. B80 extends the bandwidth to 80 MHz.

Note that the U-options as of U40 always require all lower-bandwidth options as a prerequisite, while the B-options already include them.

Max. usable I/Q BW	Required B-option	Required U-option(s)
10 MHz	-	-
28 MHz	B28	U28

Max. usable I/Q BW	Required B-option	Required U-option(s)
40 MHz	B40	U28+U40 <b>or</b> B28+U40
80 MHz	B80	U28+U40+U80 <b>or</b> B28+U40+U80 <b>or</b> B40+U80
160 MHz	B160	U28+U40+U80+U160 <b>or</b> B28+U40+U80+U160 <b>or</b> B40+U80+U160 <b>or</b> B80+U160

As a rule, the usable I/Q bandwidth is proportional to the output sample rate. Yet, when the I/Q bandwidth reaches the bandwidth of the analog IF filter (at very high output sample rates), the curve breaks.

#### Relationship between sample rate and usable I/Q bandwidth

Up to the maximum bandwidth, the following rule applies:

$$\text{Usable I/Q bandwidth} = 0.8 * \text{Output sample rate}$$



#### MSRA operating mode

In MSRA operating mode, the MSRA Master is restricted to a sample rate of 200 MHz.

The [figure 4-6](#) shows the maximum usable I/Q bandwidths depending on the output sample rates.

#### R&S FSW without additional bandwidth extension options

sample rate: 100 Hz - 10 GHz

maximum I/Q bandwidth: 10 MHz

Sample rate	Maximum I/Q bandwidth
100 Hz to 10 MHz	proportional up to maximum 10 MHz
10 MHz to 10 GHz	10 MHz

#### R&S FSW with options B28 or U28 (I/Q Bandwidth Extension):

sample rate: 100 Hz - 10 GHz

maximum bandwidth: 28 MHz

Sample rate	Maximum I/Q bandwidth
100 Hz to 35 MHz	proportional up to maximum 28 MHz
35 MHz to 10 GHz	28 MHz

**R&S FSW with option B40 or U40 (I/Q Bandwidth Extension):**

sample rate: 100 Hz - 10 GHz

maximum bandwidth: 40 MHz

Sample rate	Maximum I/Q bandwidth
100 Hz to 50 MHz	proportional up to maximum 40 MHz
50 MHz to 10 GHz	40 MHz

**R&S FSW with option B80 or U80 (I/Q Bandwidth Extension):**

sample rate: 100 Hz - 10 GHz

maximum bandwidth: 80 MHz

Sample rate	Maximum I/Q bandwidth
100 Hz to 100 MHz	proportional up to maximum 80 MHz
100 MHz to 10 GHz	80 MHz

**R&S FSW with activated option B160 or U160 (I/Q Bandwidth Extension):**

sample rate: 100 Hz - 10 GHz

maximum bandwidth: 160 MHz

Sample rate	Maximum I/Q bandwidth
100 Hz to 10 GHz	proportional up to maximum 1600 MHz

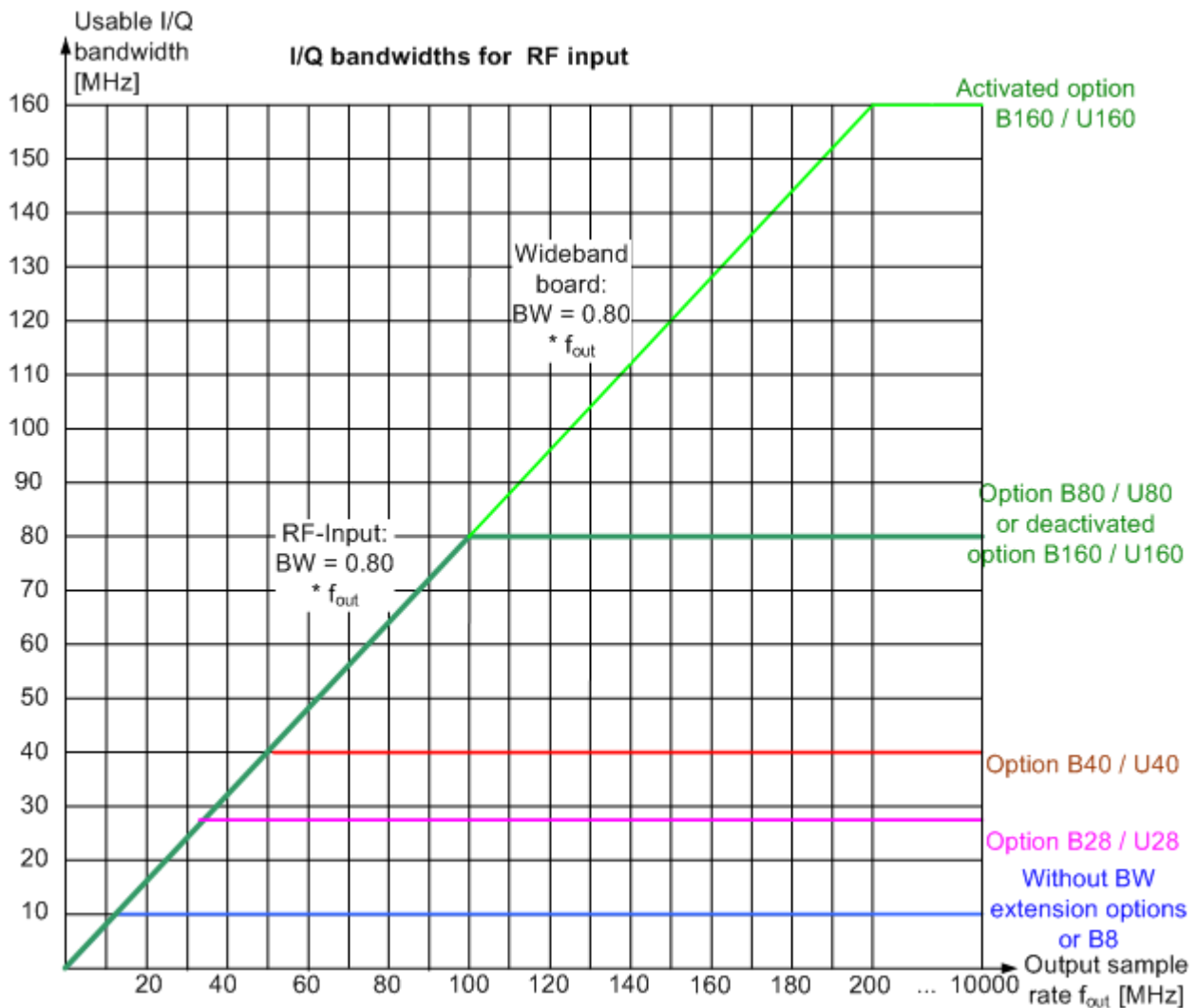


Fig. 4-6: Relationship between maximum usable I/Q bandwidth and output sample rate

## 4.2.2 Sample Rates and Bandwidths for Digital I/Q Data

### Definitions

- **Clock rate:** the rate at which data is physically transmitted between the R&S FSW and the connected instrument; both instruments must be able to process data at this rate; the clock rate of the R&S FSW at the output connector is 100 MHz
- **Input sample rate (ISR):** the sample rate of the useful data provided by the connected instrument to the digital input
- **(User, Output) Sample rate (SR):** the sample rate that is defined by the user (e.g. in the "Data Acquisition" dialog box in the "I/Q Analyzer" application) and which is used as the basis for analysis or sent to the digital output

- **Usable I/Q (Analysis) bandwidth:** the bandwidth range in which the signal remains unchanged by the digital decimation filter and thus remains undistorted; this range can be used for accurate analysis by the R&S FSW



### Slow/Q measurements

"Slow/Q" measurements are measurements where the user-defined sample rate exceeds the rate used to transfer valid samples. In the R&S FSW, the user-defined sample rate may exceed 10 GHz for "Slow/Q" measurements. This happens, for example, when an analog signal is sampled by external hardware, e.g. an oscilloscope, with a sample rate larger than 10 GHz, is stored there in a memory temporarily and then read from the memory and transmitted to the R&S FSW at a slower rate than it was sampled. In this case, make sure the input sample rate is defined correspondingly for the connected instrument (see "[Input Sample Rate](#)" on page 137).

The following table describes the restrictions for digital in- and output:

**Table 4-2: Restrictions for digital in- and output**

Parameter	Minimum	Maximum
Record length	2 complex samples	220*1024*1024 complex samples
Input sample rate (ISR)	100 Hz	10 GHz
Sample Rate (SR)		
Digital input active:	Max(100 Hz; ISR/8388608)	Max[200 MHz; Min(10 GHz; 2*ISR)]
Digital output active:	100 Hz	100 MHz
Usable I/Q bandwidth (Digital input and filter active)	Min(0.8*SR; 0.8*ISR)	

### Bandwidths

Depending on the sample rate, the following bandwidths are available:

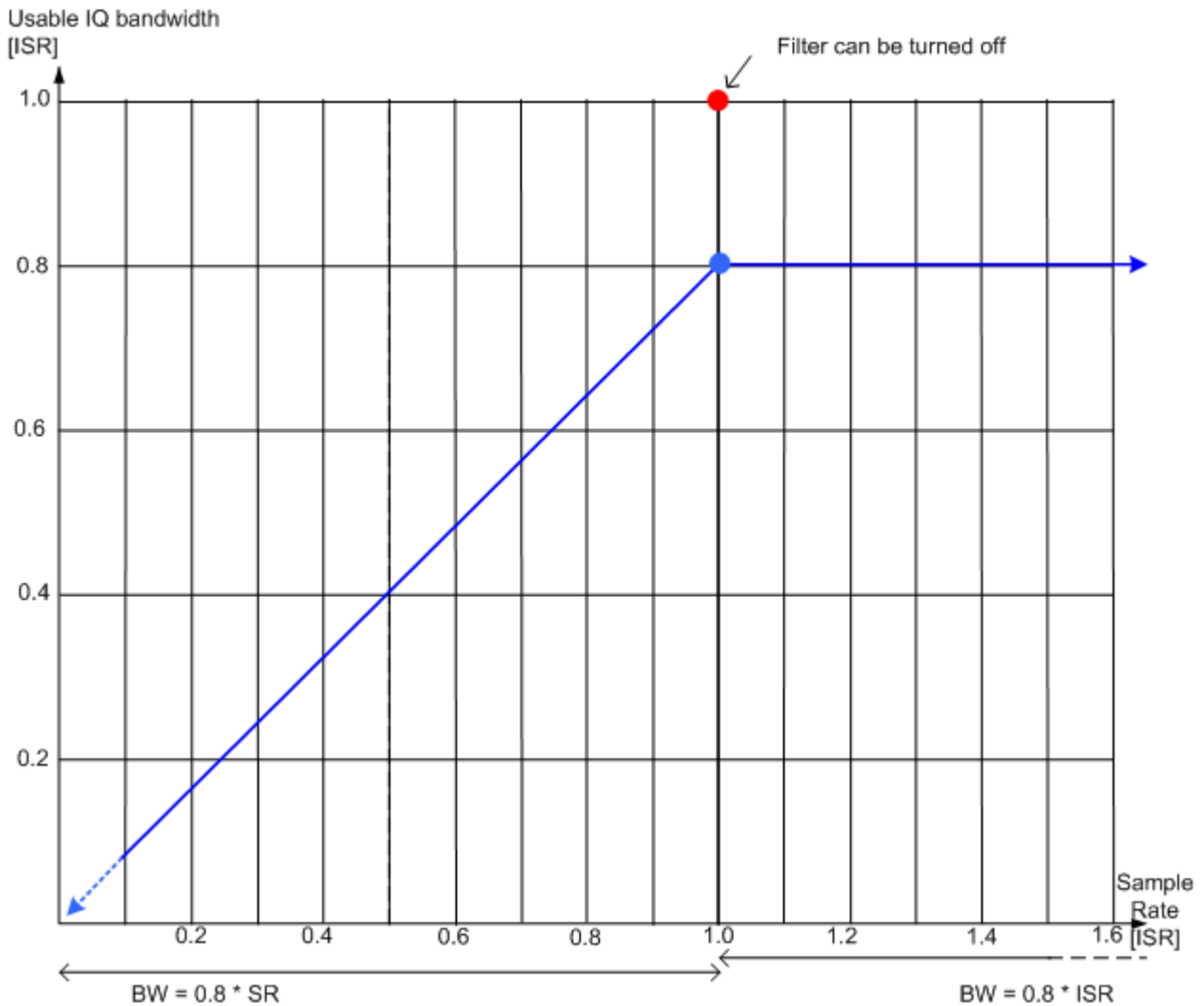


Fig. 4-7: Bandwidths depending on sample rate for active digital input

### 4.3 Symbol Mapping

Mapping or symbol mapping means that symbol numbers are assigned to constellation points or transitions in the I/Q plane (e.g. PSK and QAM).

In the analyzer, the mapping is required to decode the transmitted symbols from the sampled I/Q or frequency/time data records.

The mappings for all standards used in the analyzer and for all employed modulation modes are described in the following. Unless indicated otherwise, symbol numbers are specified in hexadecimal form (MSB at the left).

### 4.3.1 Phase Shift Keying (PSK)

With this type of modulation, the information is represented by the absolute phase position of the received signal at the decision points. All transitions in the I/Q diagram are possible. The complex constellation diagram is shown. The symbol numbers are entered in the diagram according to the mapping rule.

#### BPSK (NATURAL)

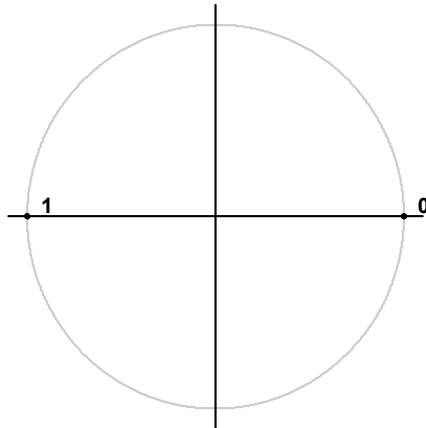


Fig. 4-8: Constellation diagram for BPSK including the symbol mapping

#### QPSK

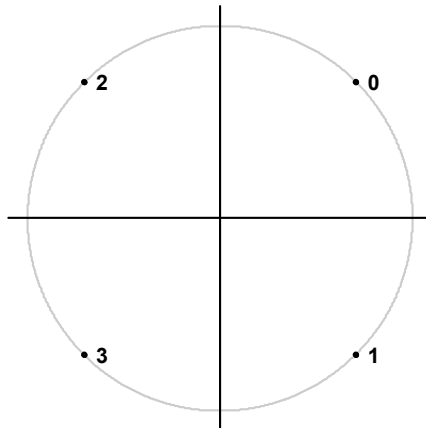
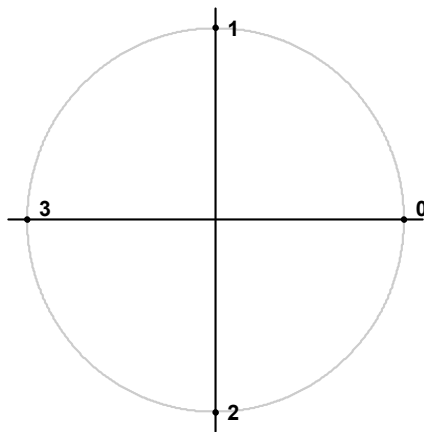
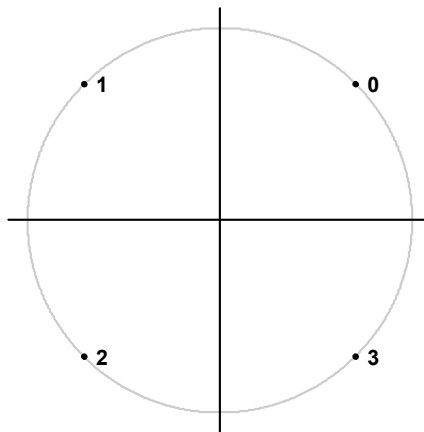


Fig. 4-9: Constellation diagram for QPSK including the symbol mapping for CDMA2000 FWD and DVB S2

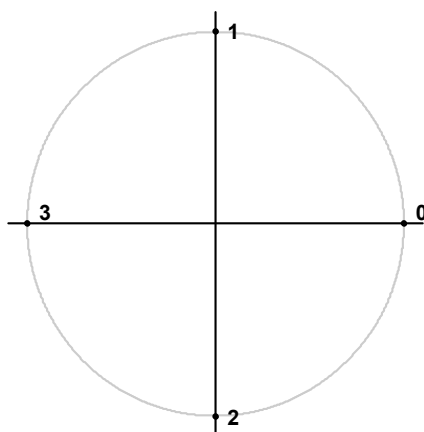




**Fig. 4-10: Constellation diagram for QPSK (GRAY) including the symbol mapping**



**Fig. 4-11: Constellation diagram for QPSK (NATURAL) including the symbol mapping**



**Fig. 4-12: Constellation diagram for QPSK including the symbol mapping for WCDMA**

8PSK

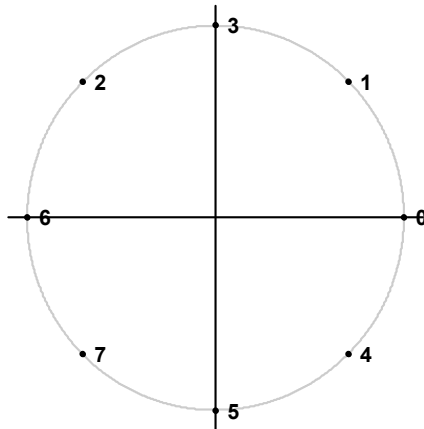


Fig. 4-13: Constellation diagram for 8PSK (GRAY) including the symbol mapping

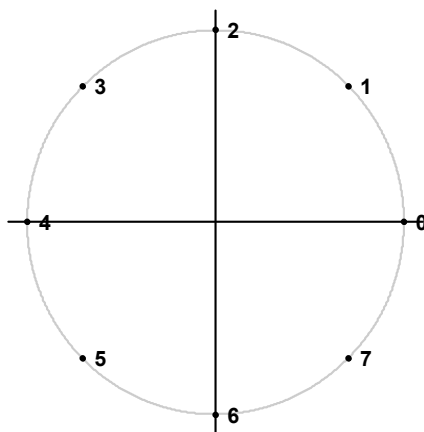


Fig. 4-14: Constellation diagram for 8PSK (NATURAL) including the symbol mapping

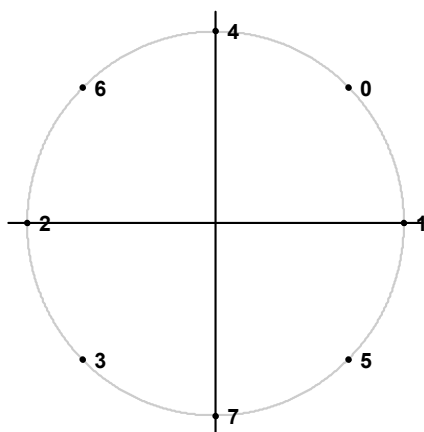


Fig. 4-15: Constellation diagram for 8PSK including the symbol mapping for DVB S2

### 4.3.2 Rotating PSK

A rotating PSK modulation is basically a PSK modulation in which additional phase shifts occur. These phase shifts depend on the symbol number, e.g. for a  $\pi/4$ -QPSK, the third symbol has an additional phase offset of  $(3-1)*\pi/4$ . This offset has the same effect as a rotation of the basic system of coordinates by the offset angle after each symbol.

The method is highly important in practical applications because it prevents signal transitions through the zeros in the I/Q plane. This reduces the dynamic range of the modulated signal and the linearity requirements for the amplifier.

In practice, the method is used for  $3\pi/8$ -8PSK, for example, and (in conjunction with phase-differential coding) for  $\pi/4$ -DQPSK.

#### Symbol mapping

The logical constellation diagram for  $3\pi/8$ -8PSK comprises 8 points that correspond to the modulation level (see figure 4-16). A counter-clockwise offset (rotation) of  $3\pi/8$  is inserted after each symbol transition.

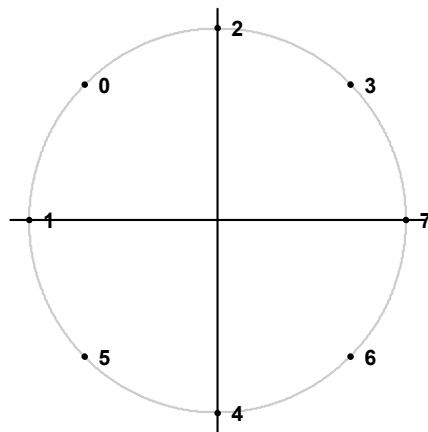


Fig. 4-16: Constellation diagram for  $3\pi/8$  8PSK before rotation including the symbol mapping for EDGE

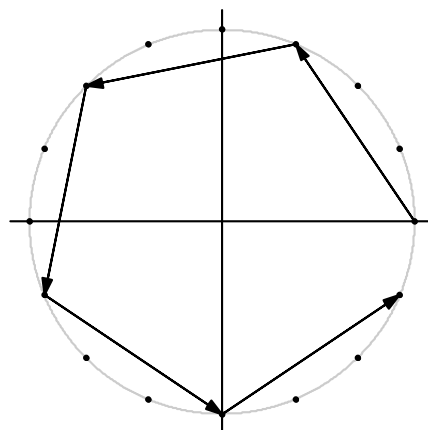


Fig. 4-17: I/Q symbol stream after  $3\pi/8$  rotation in I/Q plane if the symbol number "7" is transmitted six times in a row

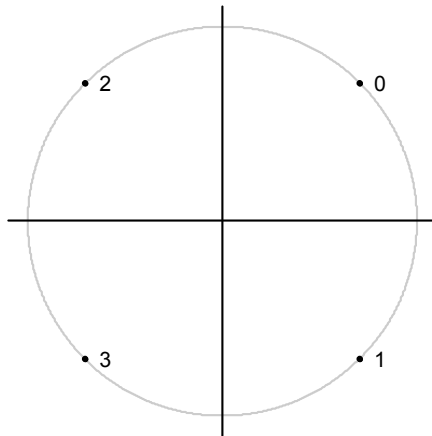


Fig. 4-18: Constellation diagram for  $3\pi/4$  QPSK including the symbol mapping for EDGE

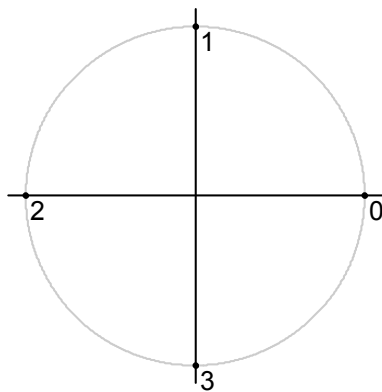


Fig. 4-19: Constellation diagram for  $\pi/4$  QPSK (Natural) including the symbol mapping

### 4.3.3 Differential PSK

With differential PSK, the information is represented in the phase shift between two consecutive decision points. The absolute position of the complex sample value at the decision point does not carry information.

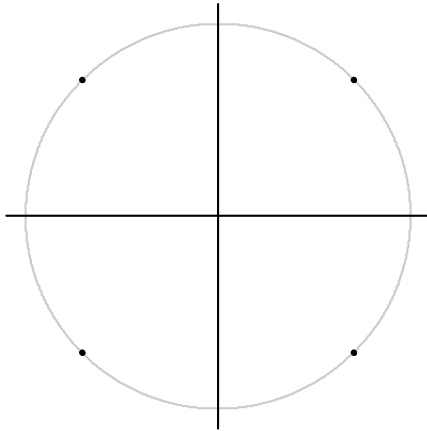
In the physical constellation diagram, the constellation points at the symbol decision points obtained after ISI-free demodulation are shown (as with common PSK methods). This diagram corresponds to the display on the analyzer. The position of the constellation points is standard-specific. For example, some QPSK standards define the constellation points on the diagonals, while other standards define the coordinate axes.

In [table 4-3](#), the symbols are assigned to phase shifts. The QPSK (INMARSAT) mapping corresponds to simple QPSK with phase-differential coding.

Tables [table 4-4](#) and [table 4-5](#) show two types of differential 8PSK modulation.

Differential coding according to VDL is shown in [table 4-6](#). It can be used for modulation types with 3 bits/symbol, e.g. 8PSK.

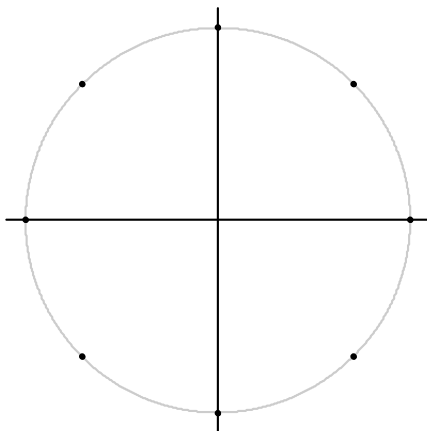
Other types of modulation using differential coding method are described in [chapter 4.3.4, "Rotating Differential PSK Modulation"](#), on page 70.



**Fig. 4-20: Constellation diagram for DQPSK (INMARSAT and NATURAL) including the symbol mapping**

**Table 4-3: DQPSK (INMARSAT)**

Logical symbol mapping				
Modulation symbol (binary indication: MSB, LSB)	00	01	10	11
Phase shift	0°	-90°	+90°	180°



**Fig. 4-21: Constellation diagram for D8PSK including the symbol mapping for APCO25, APCO25 Phase 2, GRAY, NATURAL and TETRA**

**Table 4-4: D8PSK (NATURAL)**

Logical symbol mapping								
Modulation symbol (binary indication: MSB, LSB)	000	001	010	011	100	101	110	111
Phase shift	0°	45°	90°	135°	180°	225°	270°	315°

**Table 4-5: D8PSK (GRAY)**

Logical symbol mapping								
Modulation symbol (binary indication: MSB, LSB)	000	001	010	011	100	101	110	111
Phase shift	0°	45°	135°	90°	270°	315°	225°	180°

**Table 4-6: D8PSK (VDL)**

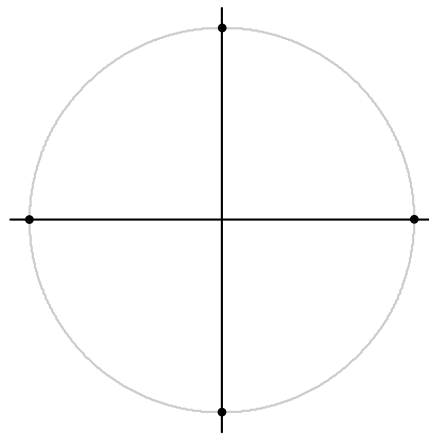
Logical symbol mapping								
Modulation symbol (binary indication: MSB, LSB)	000	001	010	011	100	101	110	111
Phase shift	0°	45°	135°	90°	315°	270°	180°	225°

### 4.3.4 Rotating Differential PSK Modulation

Phase-differential modulation is frequently combined with an additional phase shift (e.g.  $\pi/4$  DQPSK =  $\pi/4$  phase shift modulation + differential modulated 4PSK).

The logical mapping diagram corresponds to the diagram for DPSK.

The physical constellation diagram shows the symbol decision points obtained after ISI-free demodulation.



**Fig. 4-22: Constellation diagram for  $\pi/4$  DQPSK including the symbol mapping for APCO25 Phase 2, NADC, NATURAL, PDC, PHS, TETRA and TFTS; the  $\pi/4$  rotation is already compensated for**

**Table 4-7:  $\pi/4$  DQPSK (NADC, PDC, PHS, TETRA)**

Logical symbol mapping				
Modulation symbol (binary indication: MSB, LSB)	00	01	10	11
Phase shift	$0^\circ+45^\circ$	$90^\circ+45^\circ$	$-90^\circ+45^\circ$	$-180^\circ+45^\circ$

**Table 4-8:  $\pi/4$  DQPSK (TFTS)**

Logical symbol mapping				
Modulation symbol (binary indication: MSB, LSB)	00	01	10	11
Phase shift	$-180^\circ+45^\circ$	$90^\circ+45^\circ$	$-90^\circ+45^\circ$	$0^\circ+45^\circ$

**Table 4-9:  $\pi/4$  DQPSK (Natural)**

Logical symbol mapping				
Modulation symbol (binary indication: MSB, LSB)	00	01	10	11
Phase shift	$0^\circ+45^\circ$	$90^\circ+45^\circ$	$-180^\circ+45^\circ$	$-90^\circ+45^\circ$

**Table 4-10:  $\pi/4$  DQPSK (APCO25 and APCO25Phase2)**

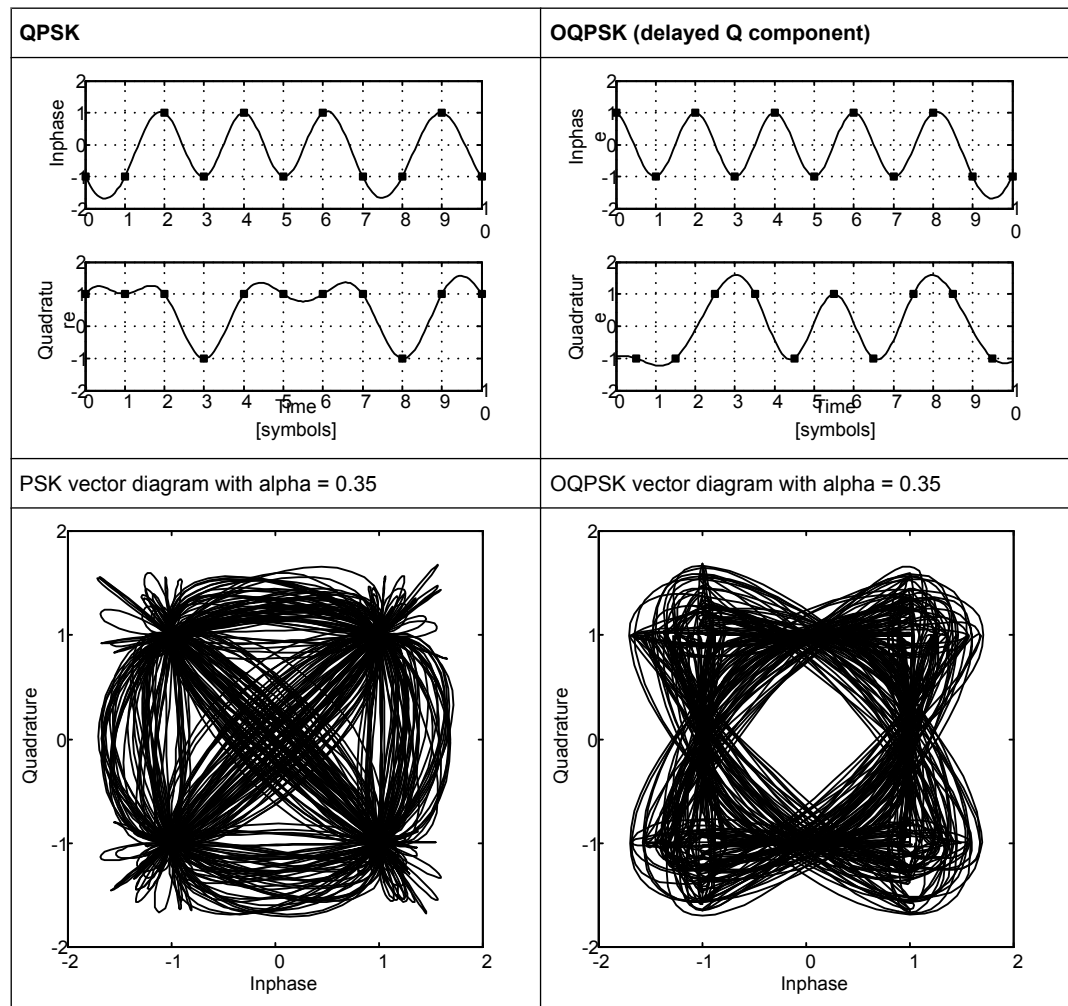
Logical symbol mapping				
Modulation symbol (binary indication: MSB, LSB)	00	01	10	11
Phase shift	$0^\circ+45^\circ$	$90^\circ+45^\circ$	$-90^\circ+45^\circ$	$-180^\circ+45^\circ$

### 4.3.5 Offset QPSK

Offset QPSK differs from "normal" QPSK in the fact that the Q component is delayed by half a symbol period against the I component in the time domain. Hence, the symbol time instants of the I and the Q component do not coincide. The concept of Offset QPSK is illustrated in the diagrams below.

## Derivation of OQPSK

Table 4-11: I/Q diagram and constellation diagram



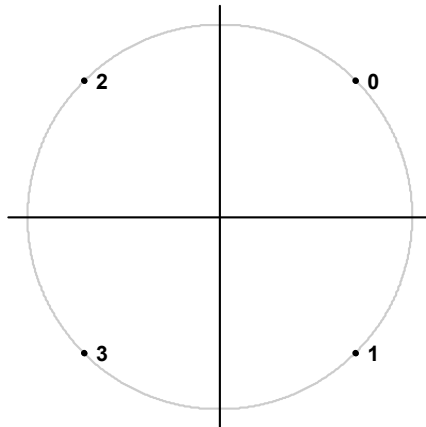
Offset QPSK reduces the dynamic range of the modulated signal (with respect to "normal" QPSK) and, therefore, the demands on amplifier linearity by avoiding zero crossings.

A distinction is made in the analyzer display:

In the Vector I/Q result display of the measurement (or reference) signal, the time delay is not compensated for. The display corresponds to the physical diagram shown in ([table 4-11](#))

In the Constellation I/Q result display of the measurement (or reference) signal, the time delay is compensated for. The display corresponds to the logical mapping as in [figure 4-23](#).



**OQPSK**

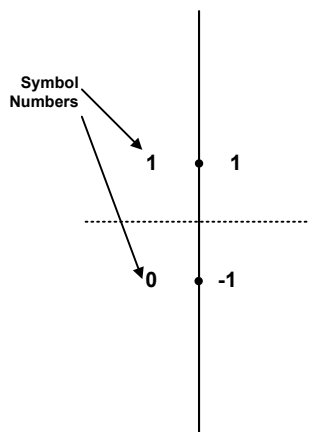
*Fig. 4-23: Constellation diagram for OQSK (GRAY) including the symbol mapping*

### 4.3.6 Frequency Shift Keying (FSK)

To illustrate symbol mappings for FSK modulations, the symbol numbers are marked in the logical mapping diagram versus the instantaneous frequency. An instantaneous frequency of zero in the baseband corresponds to the input frequency of the analyzer.

#### 2FSK (NATURAL)

With 2FSK, the symbol decision is made by a simple frequency discriminator:



*Fig. 4-24: Constellation diagram for 2FSK (NATURAL) including the logical symbol mapping*

#### 4FSK

With 4FSK, the symbol decision is made by a frequency discriminator with 3 decision thresholds ( $-2/3$ ;  $0$ ;  $+2/3$ ) normalized to the FSK reference deviation.

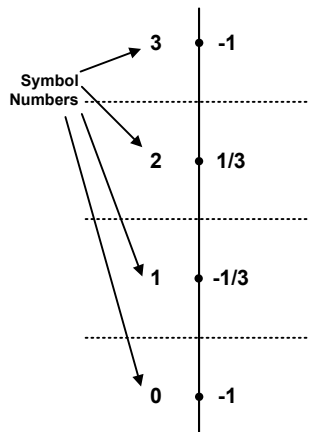


Fig. 4-25: Constellation diagram for 4FSK (NATURAL) including the logical symbol mapping

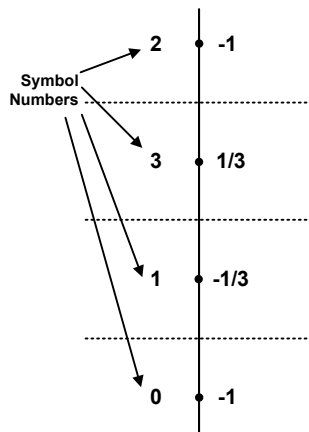


Fig. 4-26: Constellation diagram for 4FSK (GRAY) including the logical symbol mapping

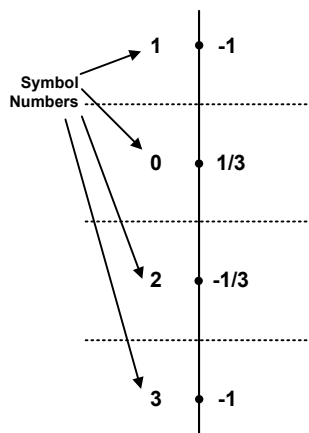


Fig. 4-27: Constellation diagram for 4FSK for APCO C4FM and APCO Phase 2 including the logical symbol mapping

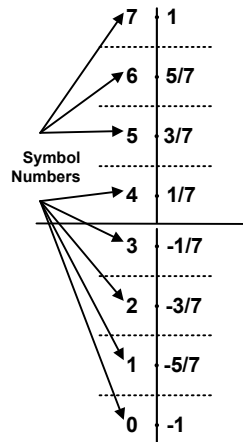
**8FSK (NATURAL)**

Fig. 4-28: Constellation diagram for 8FSK (NATURAL) including the logical symbol mapping

### 4.3.7 Minimum Shift Keying (MSK)

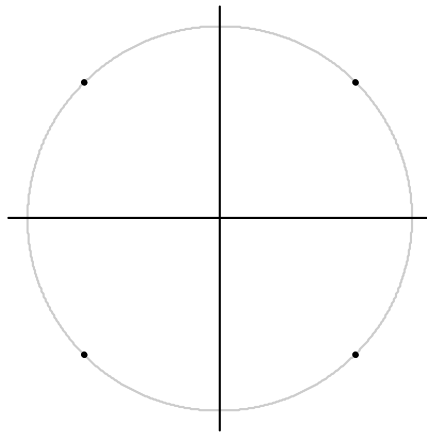
MSK modulation causes modulation-dependent phase shifts of  $\pm 90^\circ$  which can be shown in an Constellation I/Q diagram. As with PSK, demodulation is performed by evaluation of the phase positions.

Table 4-12: MSK (NATURAL)

Logical symbol mapping		
Modulation symbol (binary indication: MSB, LSB)	0	1
Phase shift	$-90^\circ$	$+90^\circ$

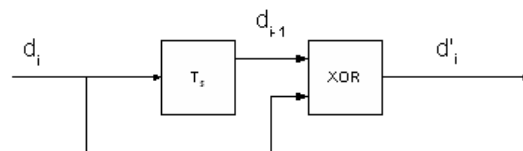
Table 4-13: MSK (GSM)

Logical symbol mapping		
Modulation symbol (binary indication: MSB, LSB)	0	1
Phase shift	$+90^\circ$	$-90^\circ$



**Fig. 4-29: MSK (for GSM and NATURAL) and DMSK Constellation Diagram including the symbol mapping**

Similar to PSK, differential coding can also be used with MSK. In this case, too, the information is represented by the transition of two consecutive symbols. The block diagram of the coder is shown below.



**Fig. 4-30: DMSK: differential encoder in the transmitter**

$d_i$  input symbol  $\{0;1\}$  of differential encoder

$d_{i-1}$  input symbol delayed by the symbol period  $T_s$

$d'_i$  output symbol  $\{0;1\}$  of differential encoder

The logical symbol mapping is then performed on the XOR-coded bitstream  $d'$ .

### 4.3.8 Quadrature Amplitude Modulation (QAM)

In the case of QAM the information is represented by the signal amplitude and phase.

The symbols are arranged in a square constellation in the I/Q plane.



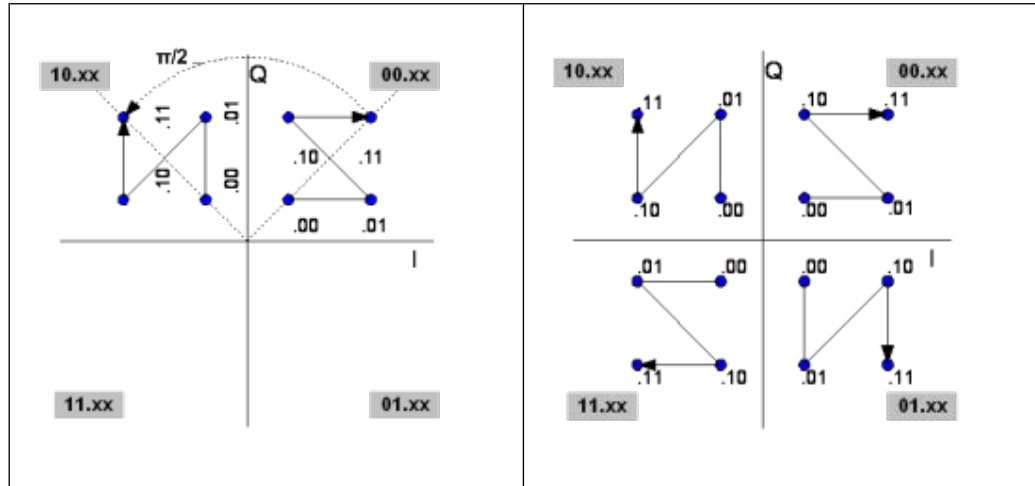
To ensure reliable demodulation, symbol numbers should be distributed evenly with respect to the symbol alphabet.

As a rule of thumb, the **result length** should correspond to at least 8 times the modulation order. For example, with 64 QAM, a result length of at least  $8 \cdot 64 = 512$  symbols should be used.

**QAM Mappings**

The following QAM mappings are obtained from the mapping of the 1st quadrant, which is always rotated by  $\pi/2$  for the subsequent quadrants and supplemented by a (GRAY-coded) prefix for each quadrant.

*Table 4-14: Derivation of QAM mappings*



In the following diagrams, the symbol mappings are indicated in hexadecimal and binary form.

• 0	• 1	• 3	• 2	• 0000	• 0001	• 0011	• 0010
• 4	• 5	• 7	• 6	• 0100	• 0101	• 0111	• 0110
• C	• D	• F	• E	• 1100	• 1101	• 1111	• 1110
• 8	• 9	• B	• A	• 1000	• 1001	• 1011	• 1010

*Fig. 4-31: Constellation diagram for 16QAM (GRAY) including the logical symbol mapping (hexadecimal and binary)*

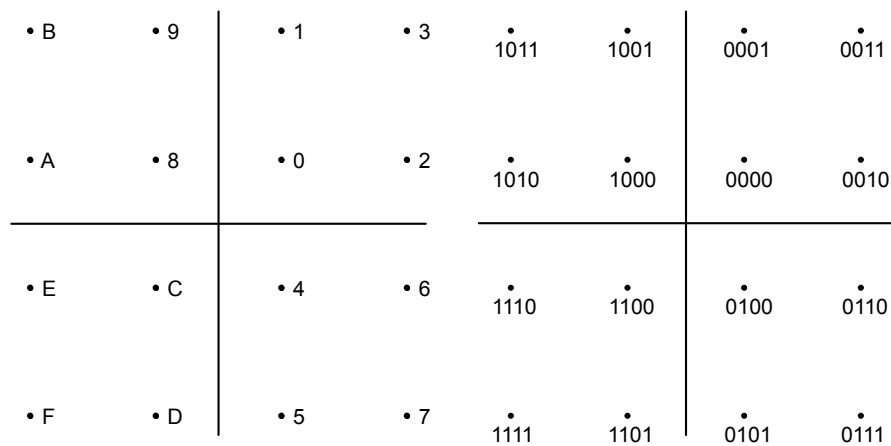


Fig. 4-32: Constellation diagram for 16QAM including the logical symbol mapping for EDGE (hexadecimal and binary)

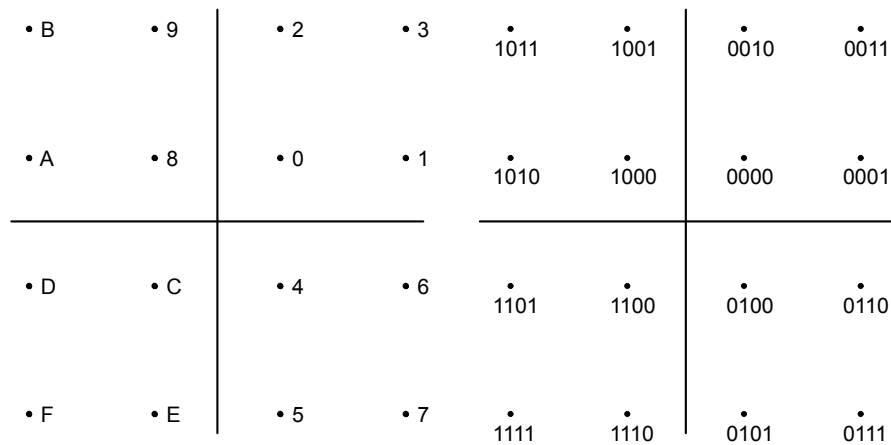


Fig. 4-33: Constellation diagram for 16QAM including the logical symbol mapping for DVB-C (hexadecimal and binary)

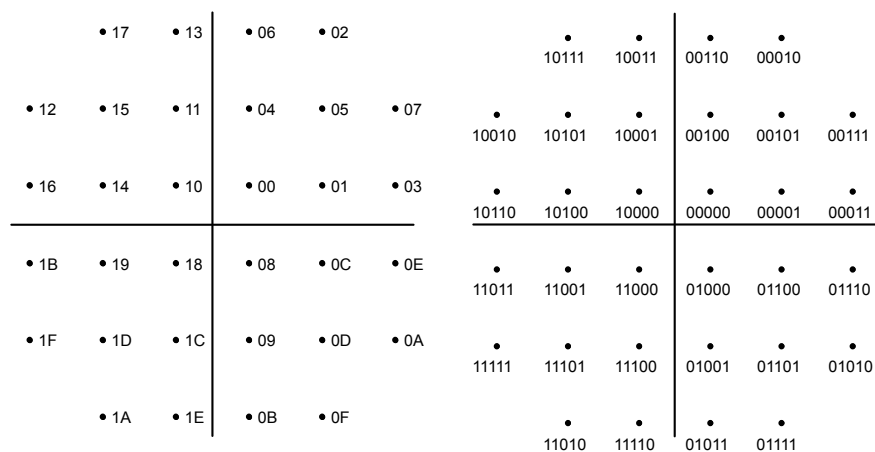


Fig. 4-34: Constellation diagram for 32QAM including the logical symbol mapping for DVB-C (hexadecimal and binary)

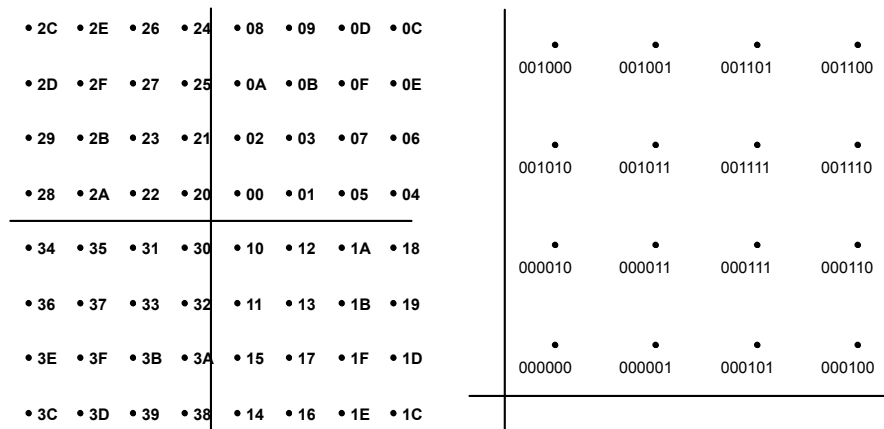


Fig. 4-35: Constellation diagram for 64QAM including the logical symbol mapping for DVB-C (hexadecimal and binary); the binary form shows the upper right section of the diagram only.

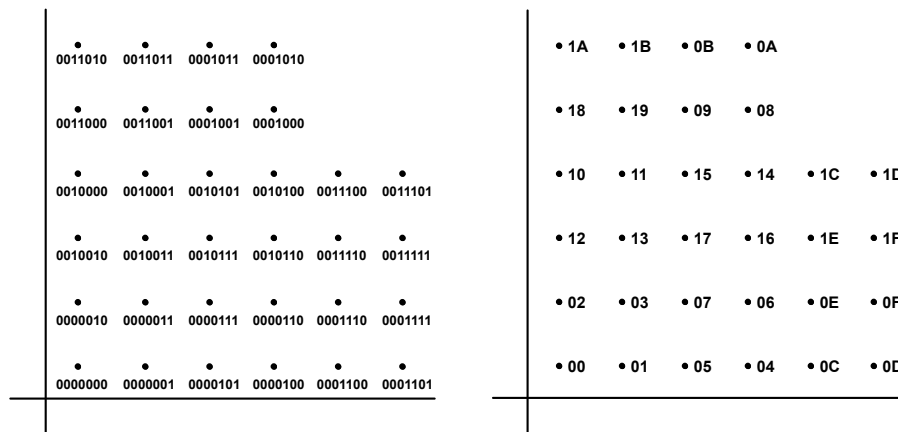


Fig. 4-36: Constellation diagram for 128QAM including the logical symbol mapping (hexadecimal and binary); the figure shows the upper right sections of the diagram only

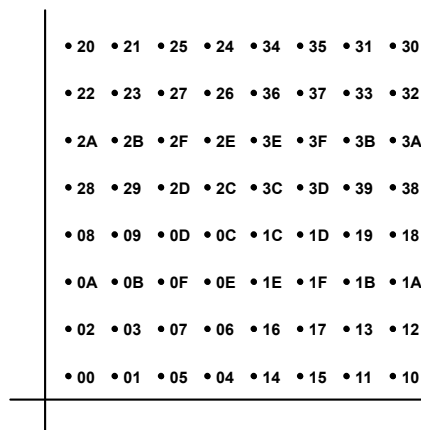


Fig. 4-37: Constellation diagram for 256QAM including the logical symbol mapping (hexadecimal); the figure shows the upper right section of the diagram only

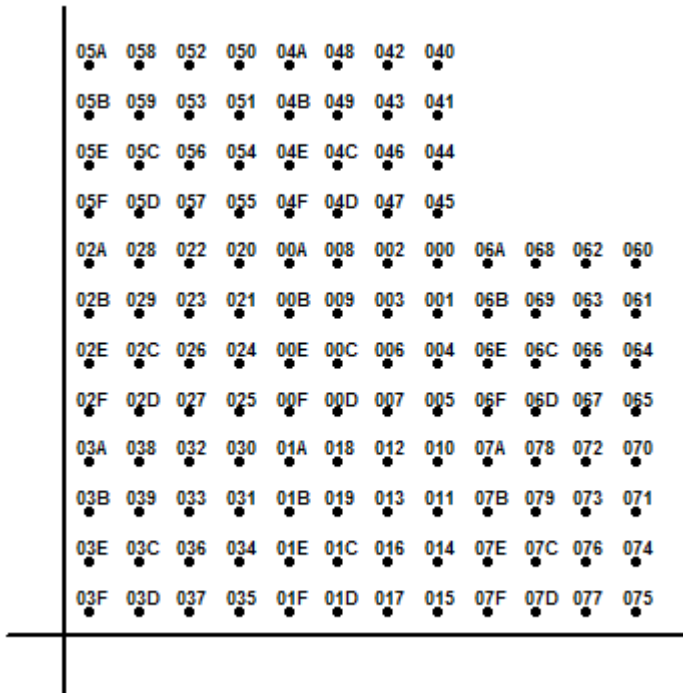


Fig. 4-38: Constellation diagram for 512QAM including the logical symbol mapping (hexadecimal); the figure shows the upper right section of the diagram only

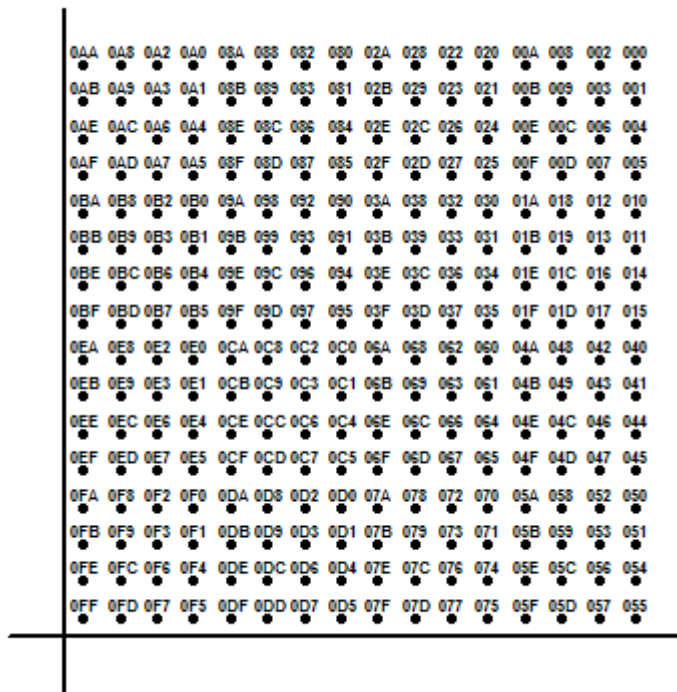


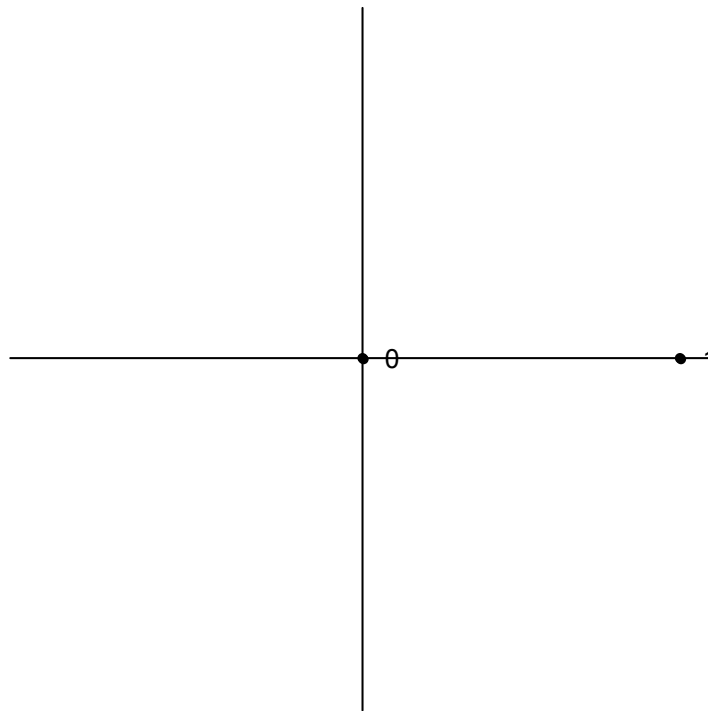
Fig. 4-39: Constellation diagram for 1024QAM including the logical symbol mapping (hexadecimal); the figure shows the upper right section of the diagram only



### 4.3.9 ASK

#### 2ASK (OOK)

ASK stands for Amplitude Shift Keying, 2ASK (binary) is often also referred to as "On Off Keying" (OOK). With this type of modulation, the information is solely represented by the absolute amplitude of the received signal at the decision points.



*Fig. 4-40: Constellation diagram for 2ASK*

#### 4ASK

4ASK is a 4-ary Amplitude Shift Keying mapping type. With this type of modulation, the information is solely represented by the absolute amplitude of the received signal at the decision points.

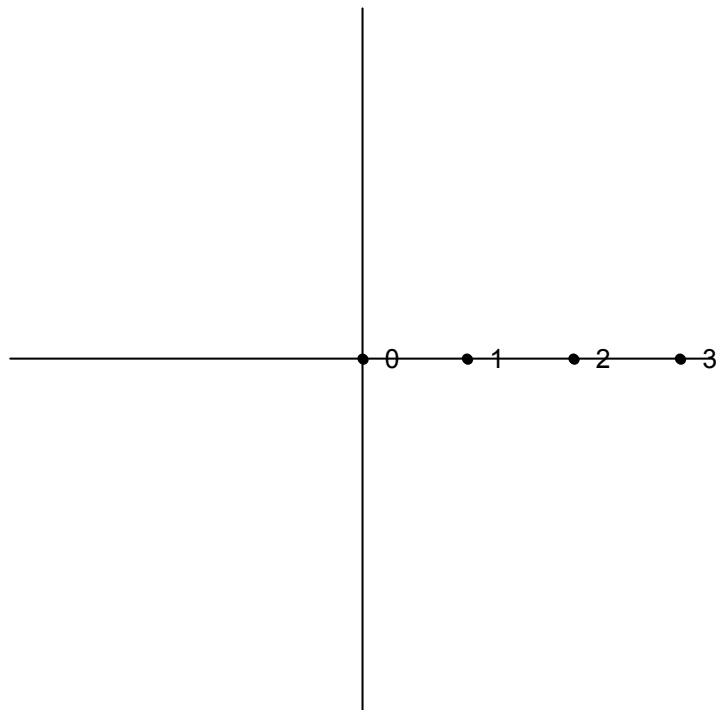


Fig. 4-41: Constellation diagram for 4ASK

### 4.3.10 APSK

With Amplitude Phase Shift Keying (APSK) modulation, the information is represented by the signal amplitude and the signal phase.

#### 16APSK

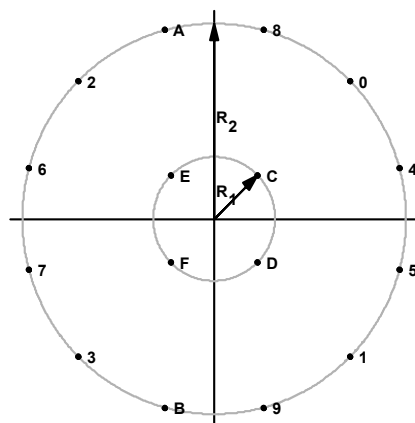


Fig. 4-42: Constellation diagram for 16APSK including the logical symbol mapping for DVB-S2

For DVB-S2 16APSK mappings, the ratio of the outer circle radius to the inner circle radius ( $\gamma = R_2/R_1$ ) depends on the utilized code rate and complies with [figure 4-42](#).

**Table 4-15: Optimum constellation radius ratio  $\gamma$  (linear channel) for 16APSK**

Code Rate	Modulation / coding spectral efficiency	$\gamma$
2/3	2.66	3.15
3/4	2.99	2.85
4/5	3.19	2.75
5/6	3.32	2.70
8/9	3.55	2.60
9/10	3.59	2.57

**32APSK**

For DVB-S2 32APSK mappings, the ratio of the middle circle radius to the inner circle radius ( $\gamma_1 = R_2/R_1$ ) and the ratio of the outer circle radius to the inner circle radius ( $\gamma_2$ ) depend on the utilized code rate and comply with [table 4-16](#).

**Table 4-16: Optimum constellation radius ratios  $\gamma_1$  and  $\gamma_2$  (linear channel) for 32APSK**

Code Rate	Modulation / coding spectral efficiency	$\gamma_1$	$\gamma_2$
2/3	3.74	2.84	5.27
3/4	3.99	2.72	4.87
4/5	4.15	2.64	4.64
5/6	4.43	2.54	4.33
8/9	4.49	2.53	4.30

**4.3.11 User-defined Modulation**

In addition to the modulation types defined by the standards, modulation (including symbol mappings) can also be defined according to user requirements. In this case, the mapping is defined and stored in a specific format (\*.vam file format) and then loaded to the VSA application. Modulation files in .vam format can be defined using a mapping wizard ("mapwiz"), an auxiliary tool provided by R&S via Internet free of charge. This tool is a precompiled MATLAB® file (MATLAB pcode). To download the tool together with a detailed description see <http://www.rohde-schwarz.com> (search term "mapwiz").

### 4.4 Overview of the Demodulation Process

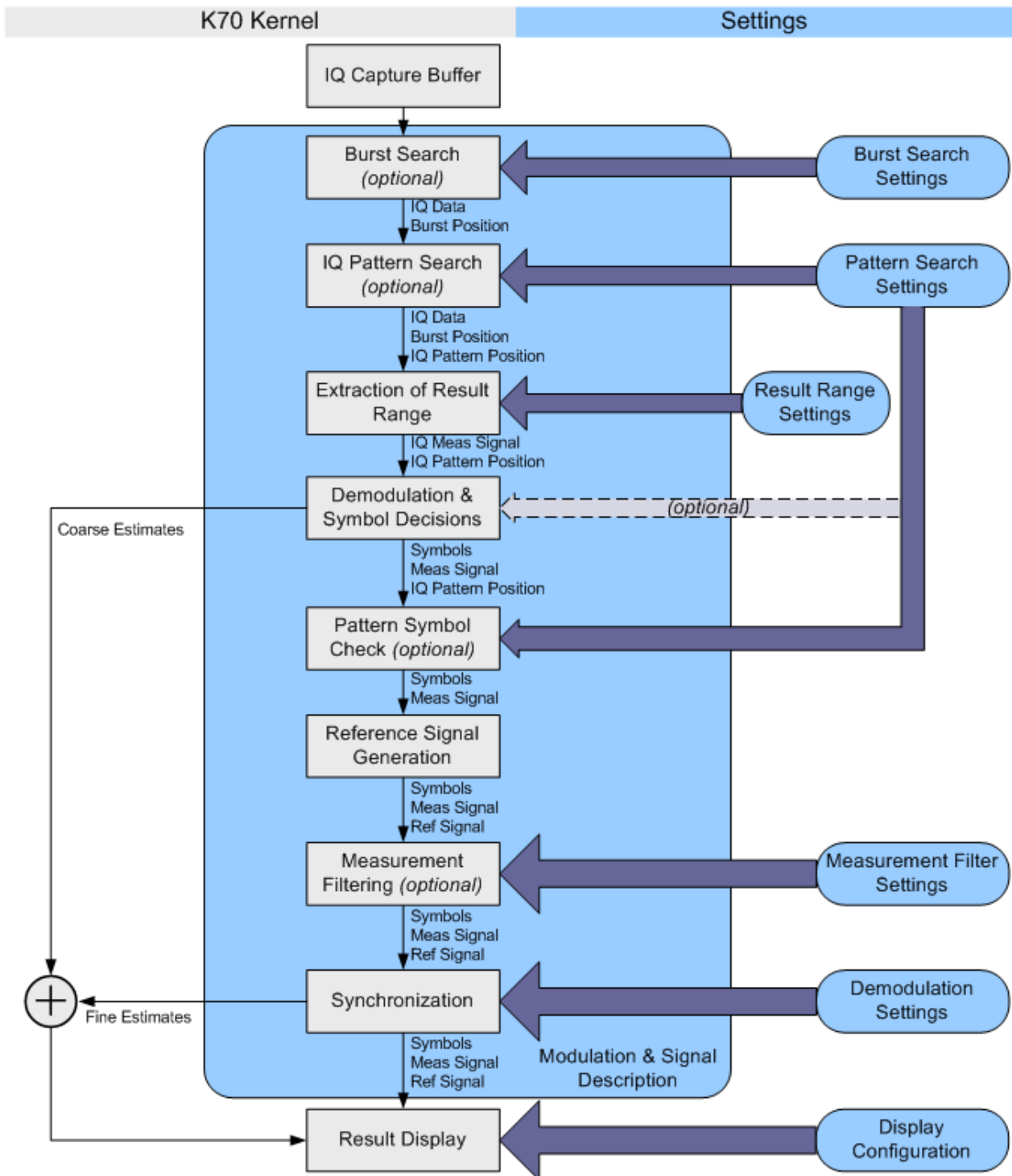


Fig. 4-43: Demodulation stages of the vector signal analysis option

The [figure 4-43](#) provides an overview of the demodulation stages of the vector signal analysis option. The function blocks of the signal processing kernel can be found at the left (in grey) and their appropriate settings at the right (in blue).

A more detailed description of the most important stages is given in the following sections.

### Burst Search

In this stage, the capture buffer is searched for bursts that comply with the signal description. The search itself can be switched on or off via the "Burst Search" dialog (see ["Enabling Burst Searches"](#) on page 162). A list of the detected bursts is passed on to the next processing stage.

### I/Q Pattern Search

The "I/Q Pattern Search" is performed on the capture buffer. This means the VSA application modulates the selected pattern according to the transmit filter (Tx filter) and the modulation scheme. Subsequently, it searches the capture buffer for this I/Q pattern, i.e. the I/Q waveform of the pattern. It is assumed that patterns can only appear within bursts, i.e. the I/Q pattern search range is limited to the bursts detected by the burst search stage. If the burst search is switched off, the whole capture buffer is searched for the I/Q pattern. A list of all detected I/Q patterns is passed on to the next processing stage. It is important to note that the VSA application can only search for one pattern at a time.

The pattern search can be switched on or off via the "Pattern Search" dialog (see ["Enabling Pattern Searches"](#) on page 163).

### Extraction of Result Range

The result range can be aligned to a burst, a pattern or simply the start of the capture buffer (see ["Reference"](#) on page 170). Within this stage, the result range is cut from the capture buffer starting at a point that is specified by the user, e.g. the start of a detected burst. The VSA application automatically takes into account filter settling times by making the internal buffers sufficiently longer than the selected result range.

### Demodulation & Symbol Decisions

This stage operates on the extracted result range and aims at making the correct symbol decisions. Within this stage, a coarse synchronization of the carrier frequency offset, the carrier phase, the scaling and the timing takes place. Furthermore, an automatically selected internal receive filter (Rx filter) is used in order to remove the inter-symbol interference as effectively as possible. The outputs of this stage are the (coarsely) synchronized measurement signal and the symbol decisions (bits). The symbol decisions are later used for the "Pattern Symbol Check" stage and for the "Reference Signal Generation" stage.

### Pattern Symbol Check

The "I/Q Pattern Search" stage can only detect whether the similarity between the I/Q pattern and the capture buffer exceeds a certain threshold and, in this way, find the most likely positions where a pattern can be found.

Within this stage, the VSA application checks whether the pattern symbols (bits) really coincide with the symbol decisions at the pre-detected position. E.g. if one out of 20 symbols does not coincide, the "I/Q Pattern Search" stage might detect this I/Q pattern, but the "Pattern Symbol Check" stage will decline it.

Note that this stage is only active if the pattern search is switched on.

### Reference Signal Generation

The ideal reference signal is generated based on the detected symbols and the specifications of the signal model, i.e. the modulation scheme and the transmit filter (Tx filter).

### Measurement Filtering

Both the measurement signal and the reference signal are filtered with the specified measurement filter.

### Synchronization

In this stage, the measurement signal and the reference signal are correlated. For PSK, QAM and MSK modulated signals, an estimation algorithm is used in order to obtain estimates for the signal amplitude, signal timing, carrier frequency error, phase error, I/Q offset, gain imbalance, quadrature error and the amplitude droop. Alternatively, it is possible to disable the estimation algorithm.

For FSK modulated signals, estimates for the signal amplitude, signal timing, carrier frequency error, FSK deviation error and the carrier frequency drift are calculated. The measurement signal is subsequently corrected with these estimates. Compensation for FSK deviation error and carrier frequency drift can be enabled or disabled.

For more information on synchronization see

- [chapter 4.5.1.2, "Estimation"](#), on page 97
- [chapter 5.9.2, "Advanced Demodulation \(Synchronization\)"](#), on page 175

### Result Display

The selected measurement results are displayed in the window(s). Configuration of the windows can be performed via the "Window Configuration" dialog (see [chapter 6.5, "Display and Window Configuration"](#), on page 196).

## 4.4.1 Burst Search

The burst search is performed only if it is switched on. Otherwise, this stage is skipped. It is recommended that you switch the burst search on if the signal is bursted. This ensures that all internal estimators are operated in time ranges where the burst power ramping is up.

In order to eliminate amplitude variations caused by noise or the modulation itself, the instantaneous power of the whole capture buffer is computed and then a moving average filter is applied. The length of this filter is automatically determined with the help of the user settings.

The filtered power of the capture buffer is subsequently compared to an automatically chosen threshold and the rising and falling edges of bursts are identified. With the help of the detected edges and some further processing, it is possible to decide whether the burst "candidates" comply with the user settings.

All bursts must have a length between ("Min Burst Length" – "Search Tolerance") and ("Max Burst Length" + "Search Tolerance") to be accepted. See ["Burst Settings"](#) on page 132 and [chapter 5.7.1, "Burst Search"](#), on page 161 for a more detailed description of these parameters.

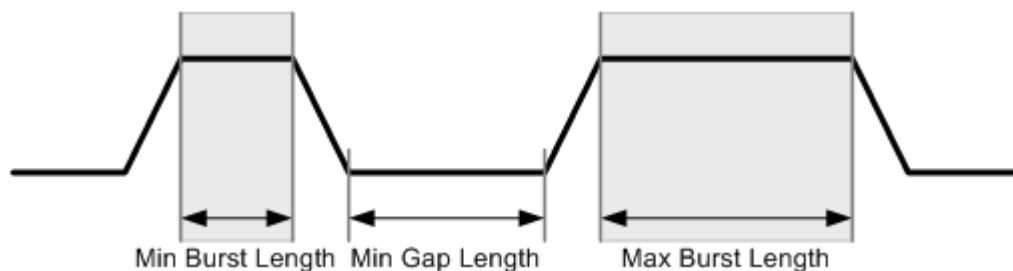
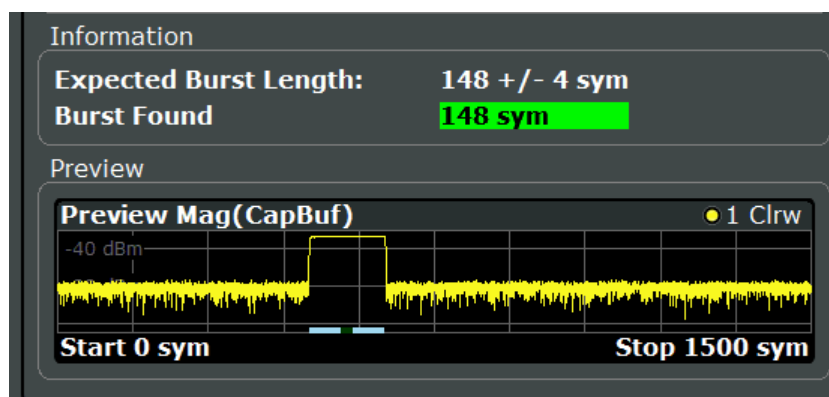


Fig. 4-44: Burst Search parameters



You can influence the robustness of the burst search directly by entering the correct minimum gap length, minimum burst length and maximum burst length (see ["Burst Settings"](#) on page 132 and ["Min Gap Length"](#) on page 162). Refer to [figure 4-44](#) for an illustration of the three parameters.

The detected bursts in the capture buffer for the current burst search settings are indicated by blue lines in the preview area of the "Burst Search" configuration dialog box (see [chapter 5.7.1, "Burst Search"](#), on page 161).



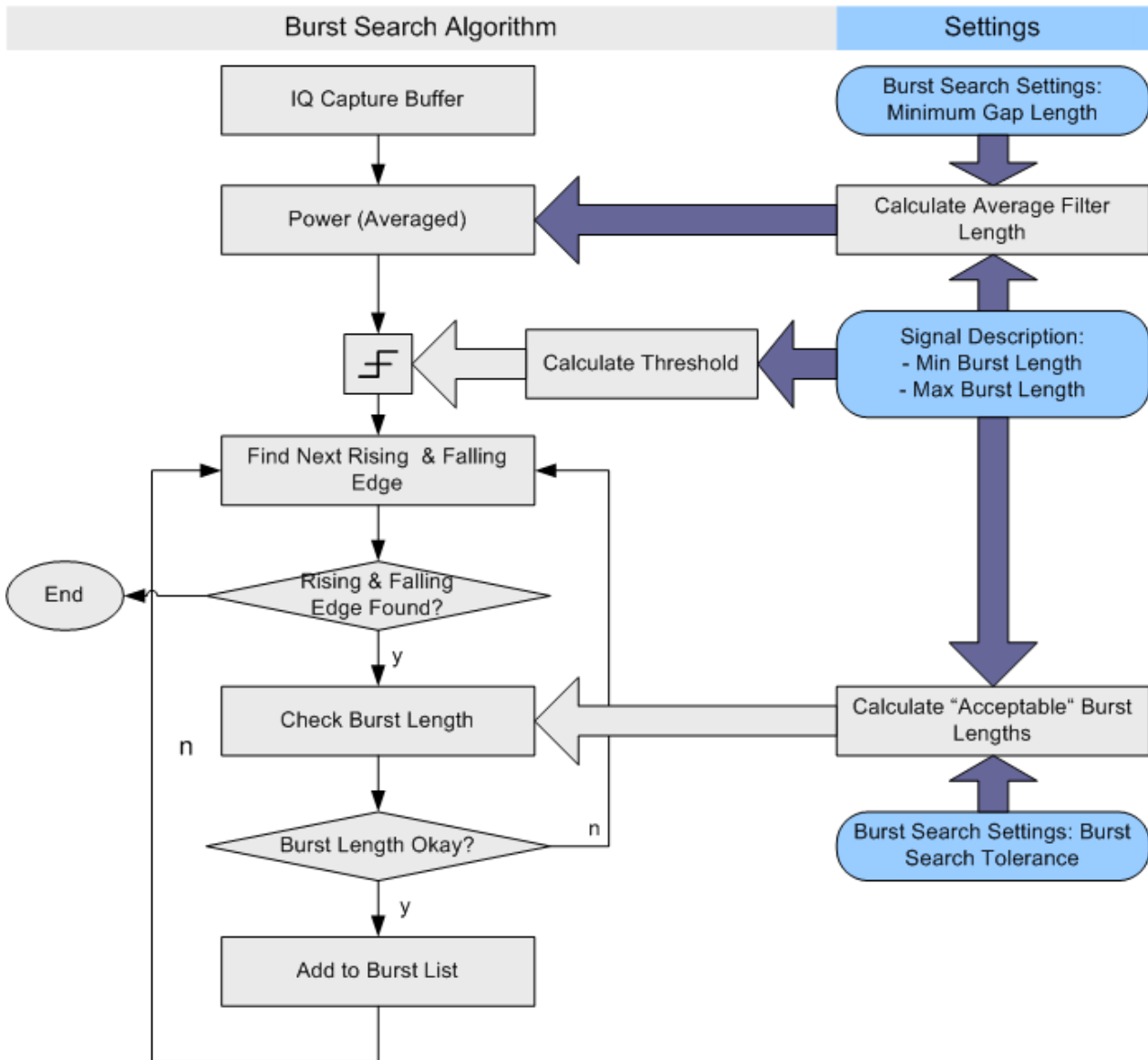


Fig. 4-45: Burst search algorithm

#### 4.4.2 I/Q Pattern Search

The I/Q pattern search is performed only if it is switched on. Otherwise, this stage is skipped. The main benefit of the I/Q pattern search is that it enables an alignment of the result range to the pattern. Furthermore, this stage can function as a filter: If the burst search and I/Q pattern search are switched on, and the parameter "Meas Only If Pattern Symbols Correct" is set to true, only bursts with the correct pattern are demodulated (see ["Meas only if Pattern Symbols Correct"](#) on page 164).

During the I/Q pattern search stage, the capture buffer is searched for an I/Q pattern by trying different time and frequency hypotheses. The I/Q pattern is generated internally, based on the specified symbol number of the pattern and the signal description (i.e.

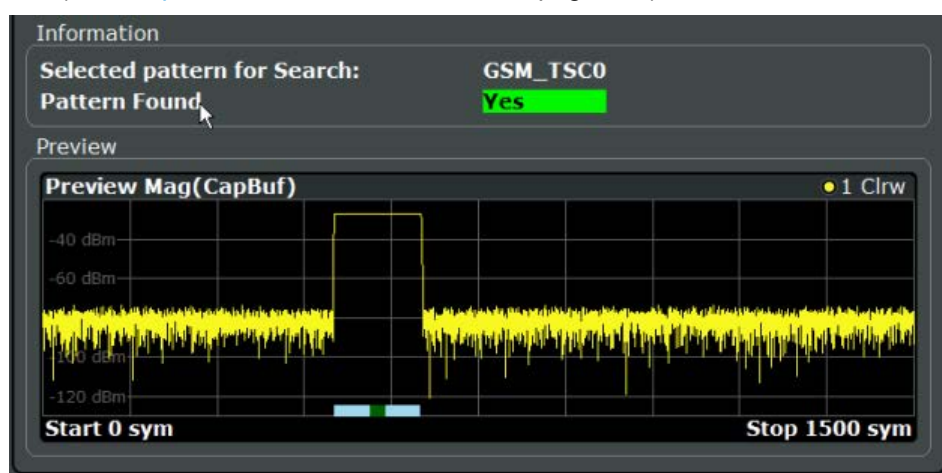


modulation scheme and transmit filter). The I/Q pattern search can also be referred to as the I/Q waveform. An I/Q pattern is considered detected if the correlation metric, i.e. the correlation value between the ideal I/Q pattern and capture buffer, exceeds a specified "I/Q Correlation Threshold" (see "I/Q Correlation Threshold" on page 164.)

If the burst search is switched on, the I/Q pattern search only searches the I/Q pattern in bursts previously detected by the burst search. Furthermore, it only finds the first I/Q pattern within each burst. If the burst search is switched off, the I/Q pattern search searches for the I/Q pattern in the entire capture buffer.



The first detected pattern in the capture buffer for the current pattern search settings is indicated by a green line in the preview area of the "Pattern Search" configuration dialog box (see chapter 5.7.2, "Pattern Search", on page 163).



### Predefined Patterns

Common standards usually have predefined pattern lists with standard specific patterns. Patterns required for the current measurement can be selected from this list. This list can be extended by patterns that are already available in the instrument. Newly created patterns can also be added to the list.

### 4.4.3 Demodulation and Symbol Decisions

This stage operates on the result range and aims to make the correct symbol decisions. The algorithm is illustrated in figure 4-46 using the example of a QPSK modulation. After timing and scaling recovery, a frequency offset and phase offset estimator is employed.

After this coarse synchronization, the VSA application makes symbol decisions, i.e. recovers which symbols were transmitted by the device under test (DUT).

Typically, the employed estimators are "non-data-aided" (NDA) estimators. This means that they operate on an unknown data sequence. Since the local oscillators (LO) of the transmitter (device under test) and the receiver (R&S FSW) are normally not coupled, their phase offset with respect to each other is unknown. The unknown transmission delay between DUT and R&S FSW adds a further unknown phase offset.

Due to this unknown phase offset, the result of the demodulation can be ambiguous with respect to the absolute phase position because of the rotational symmetry of e.g. a PSK constellation. For example, in the case of non-differential QPSK modulation, the measurement signal, the reference signal and the decided I/Q symbols may have a constant phase offset of  $\{0, \pi/2, \pi, \text{ or } 3\pi/2\}$ . This offset can only be detected and eliminated if a pattern was successfully detected at symbol level (see also [chapter 4.4.4, "Pattern Symbol Check"](#), on page 92).

If modulation types are used where the information is represented by the phase transition, e.g. differential PSK or MSK, the absolute phase position is not an issue. Thus, the ambiguity of the starting phase does not have an influence on the symbol decisions.

If the measurement signal contains a known pattern, it is also possible to use a "data-aided" (DA) estimator at this stage. This means that the estimator operates on a known data sequence, i.e. the pattern. If the signal contains a pattern, it is possible to choose between the above-described non-data-aided estimator and the data-aided estimator with the setting "[Coarse Synchronization: Pattern](#)". If the data-aided estimator is employed, the phase ambiguity can be resolved at this stage.

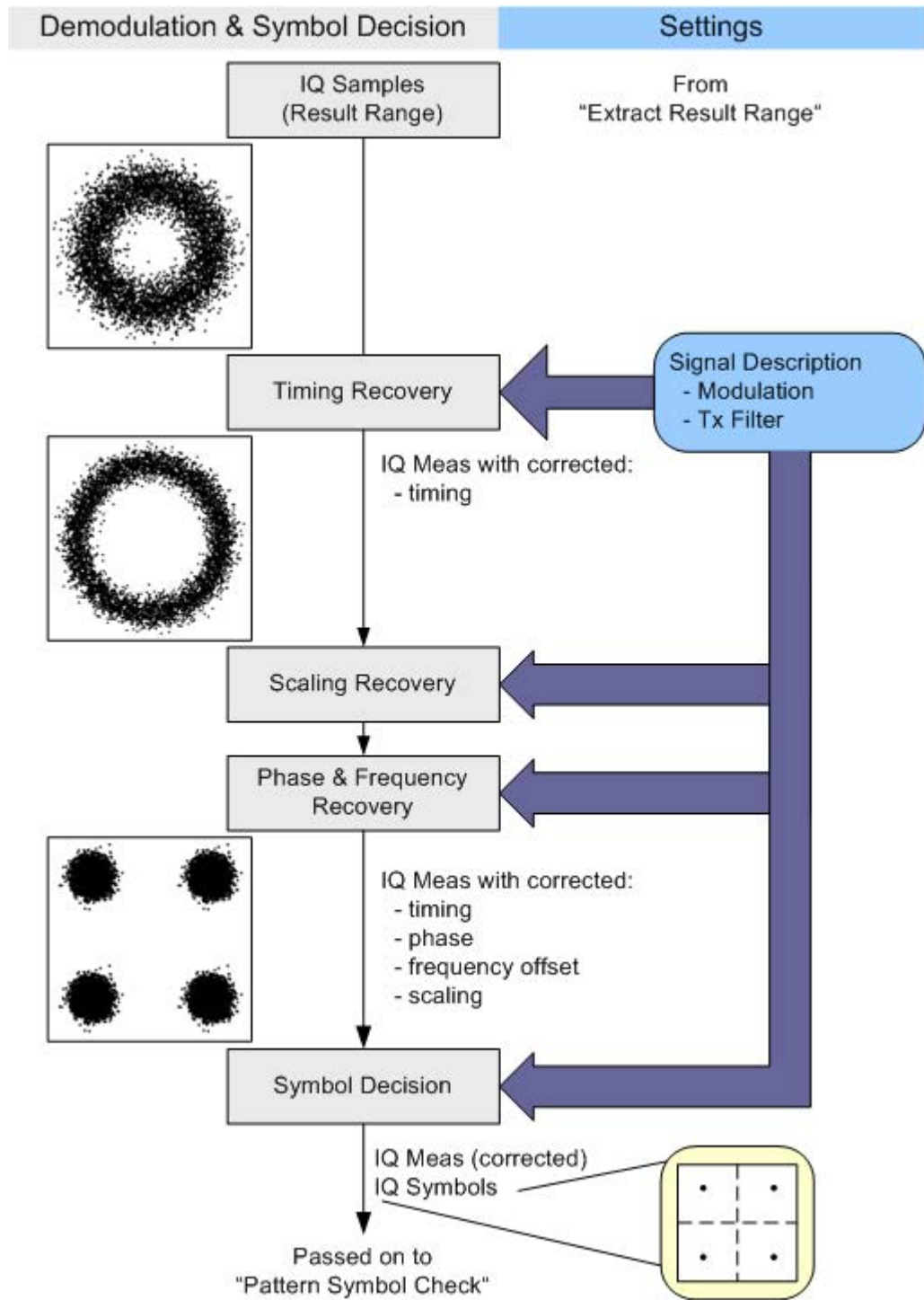


Fig. 4-46: Demodulation and Symbol Decision algorithm

#### 4.4.4 Pattern Symbol Check

This stage performs a bit-by-bit comparison between the selected pattern and the demodulated bits. It is important to note that this comparison is only performed at positions that have been identified by the I/Q pattern search as possible pattern positions. The algorithm and a simple example are illustrated in [figure 4-47](#).

First, the pattern candidate bits are extracted from the whole bitstream calculated by the "Demodulation & Symbol Decisions" stage. This means that the symbol stream is cut at the position that has been detected by the [I/Q Pattern Search](#) as the start of the pattern. The extracted sequence is then compared to the selected pattern.

If the demodulation has been ambiguous with respect to the absolute phase position, the extracted sequence needs to be compared to all possible rotated versions of the selected pattern. For example, in the case of QPSK modulation, the rotational symmetry has the order four, i.e. there are four pattern hypotheses. If the extracted sequence coincides with one of the hypotheses, the pattern is declared as "found" and the absolute phase corresponding to the appropriate hypothesis is passed on. Both the symbol decisions and the I/Q measurement signal are then rotated with this pattern phase (for the whole result range), thus resolving the phase ambiguity.

For more information refer to:

- [chapter 4.4.3, "Demodulation and Symbol Decisions"](#), on page 89
- [chapter 4.4.2, "I/Q Pattern Search"](#), on page 88

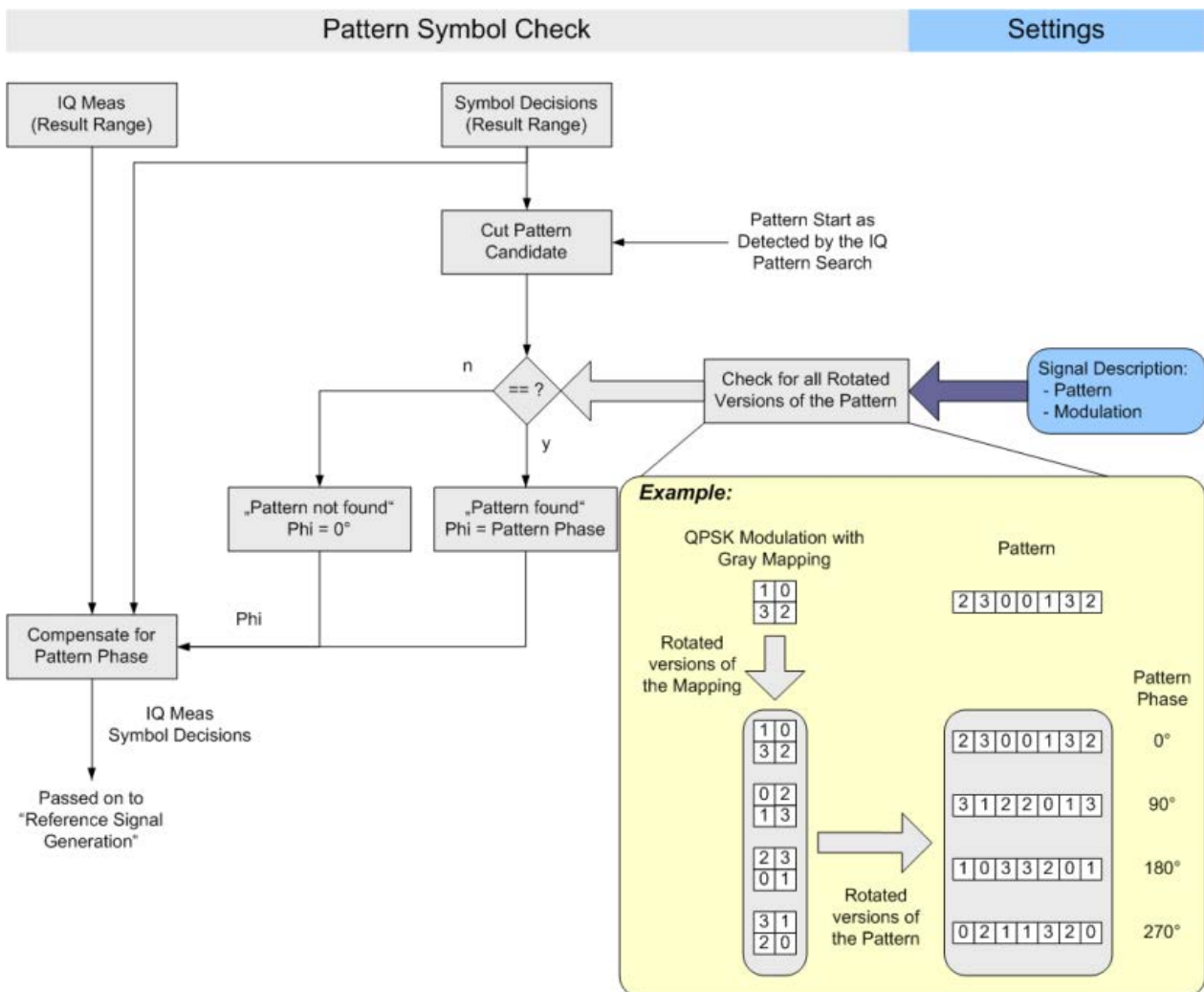


Fig. 4-47: Pattern Symbol Check algorithm

#### 4.4.5 The Equalizer

A possible source of high modulation errors of the DUT with PSK and QAM signals is a non-flat frequency response or ripple in frequency response within the modulation bandwidth.

This could be caused by the DUT's:

- Analog filter sections
- Digital filter sections, if a shortened filter length is used
- Digital arithmetic sections, if a shortened bit-length is used

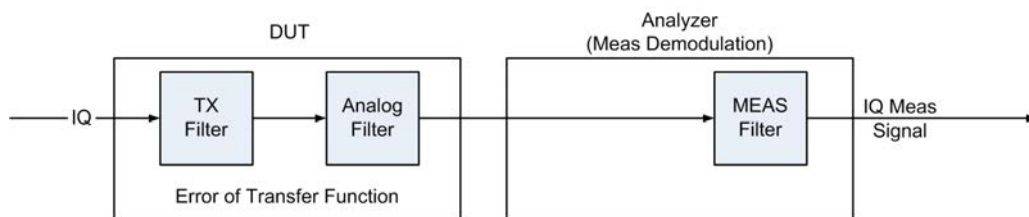


Fig. 4-48: General processing in the modulation- and demodulation stages

An equalizer filter with a reverse frequency response characteristic is able to compensate less distorted frequency responses in order to improve the modulation analysis results (see figure 4-49).

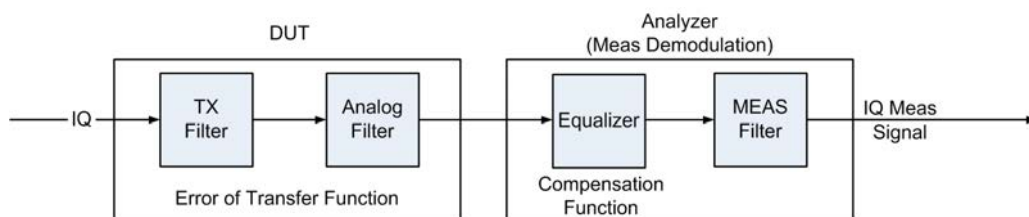


Fig. 4-49: Compensation of the transfer function's error by inserting an equalizer in the receive path

For small distortions the reference signal can be determined correctly without pre-equalization. The equalizer can be calculated by comparing the reference signal and the measured signal and is only applied to the measured signal. This is referred to as **normal equalizer mode**. Note that the resulting equalizer function is not simply the inverted distortion function.

For more complex distortions the reference signal might not be determined correctly due to wrong symbol decisions. Despite the resulting imperfect equalizer calculation, the estimated equalizer is often good enough to improve the reference signal creation in the succeeding sweep. Thus, the new equalizer is improved successively. This processing mode of the equalizer is called **tracking mode**. After only few sweeps, the results are sufficiently accurate and the learning phase is completed. Then the equalizer can be used without additional calculations as long as the input signal remains stable. If an unstable input has led to an unusable equalizer filter, reset the equalizer with the "Reset" button.

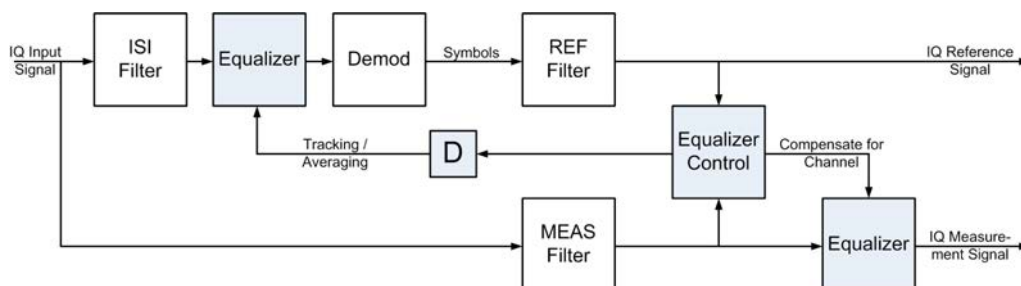


Fig. 4-50: An equalizer filter can be activated in the reference and measurement signal path. The filter coefficients are determined in such a way that the error vector magnitude (EVM) is minimized.

The result range used for equalizer calculation might be quite short leading to unstable equalizer impulse responses. For time-invariant channels the estimation length can be

extended using **Averaging mode**. In this case, the statistics from *all* previously determined reference signals and measurement signals are averaged to determine the current equalizer function. Thus, the results of previous sweeps are continuously considered to calculate the current equalizer values. Averaging is only restarted when the instrument is switched off or when the user manually resets the equalizer. Obviously, this method requires a stable input signal for the entire duration of the measurement, as otherwise the current equalizer is distorted by previous results.

This process requires extended calculation time so that the measurement update rate of the instrument decreases distinctly. When the distortions are compensated sufficiently, this averaging process can be stopped. The current filter is **frozen**, that means it is no longer changed.

Keep in mind that in Tracking and Averaging mode for sweep counts > 1 repeated analysis of past result ranges might lead to differing readings.

The equalizer algorithm is limited to PSK and QAM modulation schemes, as the optimization criterion of the algorithm is based on minimizing the mean square error vector magnitude. Thus it cannot be used for FSK modulation.

#### User-defined equalizers

Instead of tracking equalizer values repeatedly for different input signals, you can store existing values to a file and load them again later. This is useful if signals from the same input source are measured frequently. In this case, you only have to perform a calculation once and can use the same equalizer filter again and again.

#### Filter length

The length of the equalizer can be defined in symbols. The longer the equalizer the higher the resolution in the frequency domain is and the more distortion can be compensated. The shorter the filter length, the less calculation time is required during the equalizer's tracking or averaging phase.

#### Estimation points per symbol

You can define how many sample points are used for the equalizer calculation at each symbol ("Estimation points per symbol", see [chapter 4.7, "Display Points vs Estimation Points per Symbol"](#), on page 115). Typically, this is one point per symbol (= **symbol rate**) or a factor of 2.

#### Channel EVM

The equalizer not only compensates for distortions in the measurement signal, but also improves the accuracy of the estimated ideal reference signal. Thus, it is usually recommendable to enable the equalizer once you have analyzed the original input signal on the R&S FSW. By default, the error results are calculated using the compensated values if the equalizer is enabled. However, you can disable the compensation for channel results in order to analyze the actual error values obtained from the distorted channel.

## 4.5 Signal Model, Estimation and Modulation Errors

This section describes the signal and error models used within the VSA application. The estimation algorithms used to quantify specific modulation errors are then outlined. The descriptions vary depending on the modulation type.

- 4.5.1 PSK, QAM and MSK Modulation.....96
  - 4.5.1.1 Error Model.....96
  - 4.5.1.2 Estimation.....97
  - 4.5.1.3 Modulation Errors.....98
- 4.5.2 FSK Modulation.....106
  - 4.5.2.1 Error Model.....107
  - 4.5.2.2 Estimation.....109
  - 4.5.2.3 Modulation Errors.....110

### 4.5.1 PSK, QAM and MSK Modulation

#### 4.5.1.1 Error Model

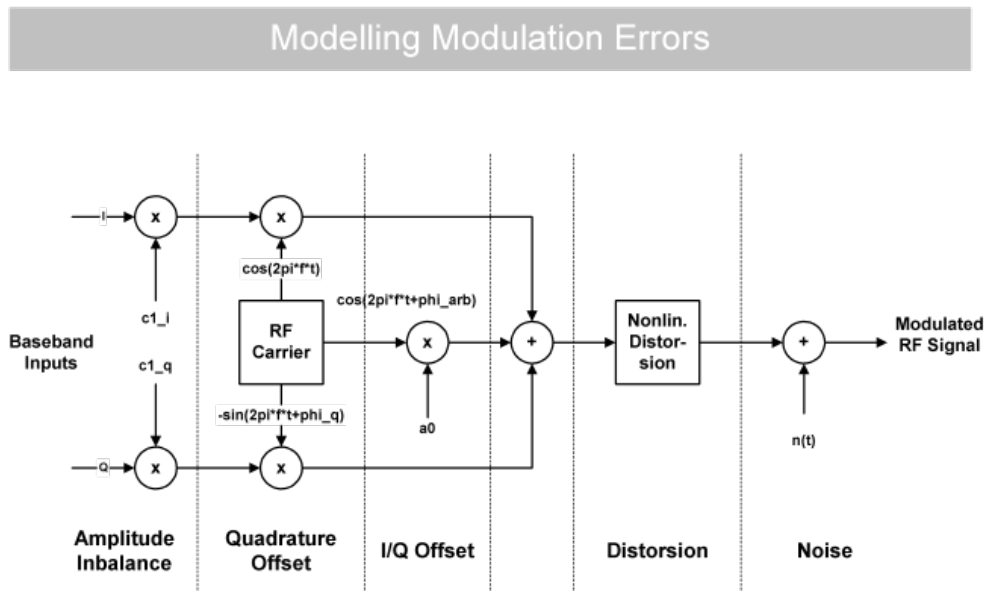


Fig. 4-51: Modelling Modulation Errors

The measured signal model for PSK, QAM and MSK modulation is shown in figure 4-51 and can be expressed as:

$$MEAS(t) = (g_I \cdot REF_I(t - \tau) + c_I + j \cdot (g_Q \cdot REF_Q(t - \tau) + c_Q)) e^{j \cdot \theta} e^{j \cdot (2\pi f_0 t + \phi) - \alpha t} + n(t)$$



where:

$REF_I(t)$  and  $REF_Q(t)$ : the inphase and quadrature component of the reference signal

$g_I$  and  $g_Q$ : the effects of the gain imbalance

$c_I$  and  $c_Q$ : the effects of an I/Q offset

$\vartheta$ : the quadrature error

$\alpha$ : the amplitude droop

$f_0$ : the carrier frequency offset

$\varphi$ : the carrier phase offset

$\tau$ : the timing offset

$n(t)$ : a disturbing additive noise process of unknown power

#### 4.5.1.2 Estimation

The VSA application includes two synchronization stages. The first stage has already been described in the context of the "Demodulation & Symbol Decisions" block (see [chapter 4.4.3, "Demodulation and Symbol Decisions"](#), on page 89).

The second stage is realized within the "Synchronization" block. Here, the measurement signal is matched to the reference signal by minimizing the mean square of the error vector magnitude. This is done by selecting the optimum parameter vector  $\hat{x}$ :

$$\hat{x} = \arg \min_x \left\{ \sum_t |MEAS(t) - REF(t, \tilde{x})|^2 \right\}$$

The minimization takes place at the sample instants specified by the [Estimation Points/Sym](#) parameter, i.e.

$$t = n \cdot T_E$$

with  $T_E$ : the sampling period used for estimation

Subsequently, the measurement signal is corrected with the determined parameter vector. Note that with a subset of the parameters, you can enable or disable correction (see [chapter 5.9.1, "Demodulation - Compensation"](#), on page 172).

#### Estimation ranges

The "estimation ranges" are determined internally according to the signal description:

- For continuous signals, the estimation range corresponds to the entire result range, since it can then be assumed that the signal consists of valid modulated symbols at all time instants.
- For bursted signals, the estimation range corresponds to the overlapping area of the detected burst and the "Result Range". Furthermore, the Run-In/Run-Out ranges (see ["Burst Settings"](#) on page 132) are explicitly excluded from the estimation range.

In the special case that the signal is indicated as a "burst signal", but is so highly distorted that the burst search cannot detect a burst, the estimation range corresponds to the pattern and (if an offset of the pattern is indicated) the useful part of the burst from its start to the pattern start.

#### 4.5.1.3 Modulation Errors

##### Error vector (EV)

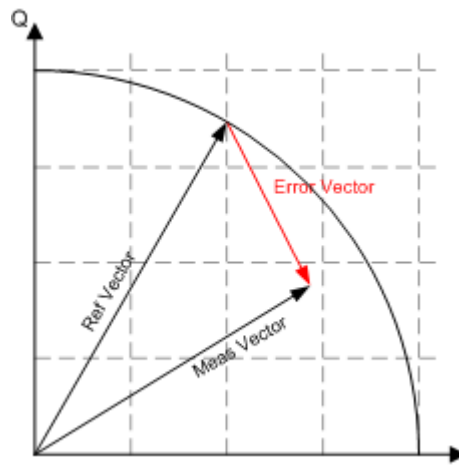


Fig. 4-52: Modulation error: error vector

The error vector is the difference between the measurement signal vector (Meas vector) and the reference signal vector (Ref vector).

##### Error Vector Magnitude (EVM)

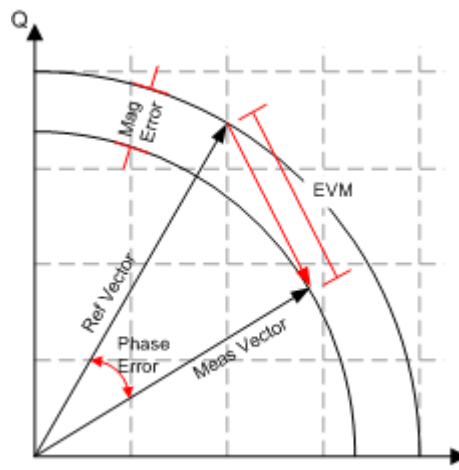


Fig. 4-53: Modulation error: EVM, magnitude error, phase error

The magnitude of the error vector in the diagram is specified as the error vector magnitude (EVM). It is commonly normalized to the mean reference power. The EVM should not be confused with the magnitude error, see below.

### Magnitude Error

The magnitude error is defined as the difference between the measurement vector magnitude and the reference vector magnitude (see [figure 4-53](#)).

### Phase Error

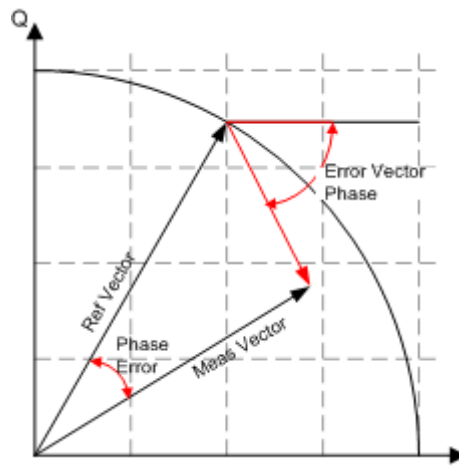


Fig. 4-54: Modulation error: Phase error, error vector phase

The phase error is the phase difference between the measurement vector and the reference vector.

$$PHASE\_ERR(t) = PHASE_{MEAS}(t) - PHASE_{REF}(t)$$

This measurement parameter is of great importance for MSK modulation measurements.

The phase error should not be confused with the error vector phase. The error vector phase is the absolute phase of the error vector (see [figure 4-54](#)).

The effects of the different modulation errors in the transmitter on the result display of the analyzer are described in the next topics. All diagrams show the equivalent, complex baseband signal.

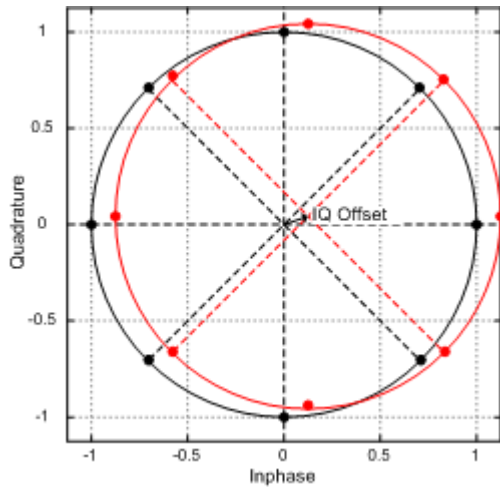
### Modulation Error Ratio (MER)

The modulation error ratio (MER) is closely related to EVM:

$$MER = -20 \cdot \log_{10}(EVM)$$

where the EVM is normalized to the mean reference power.

**I/Q Offset (Origin Offset)**



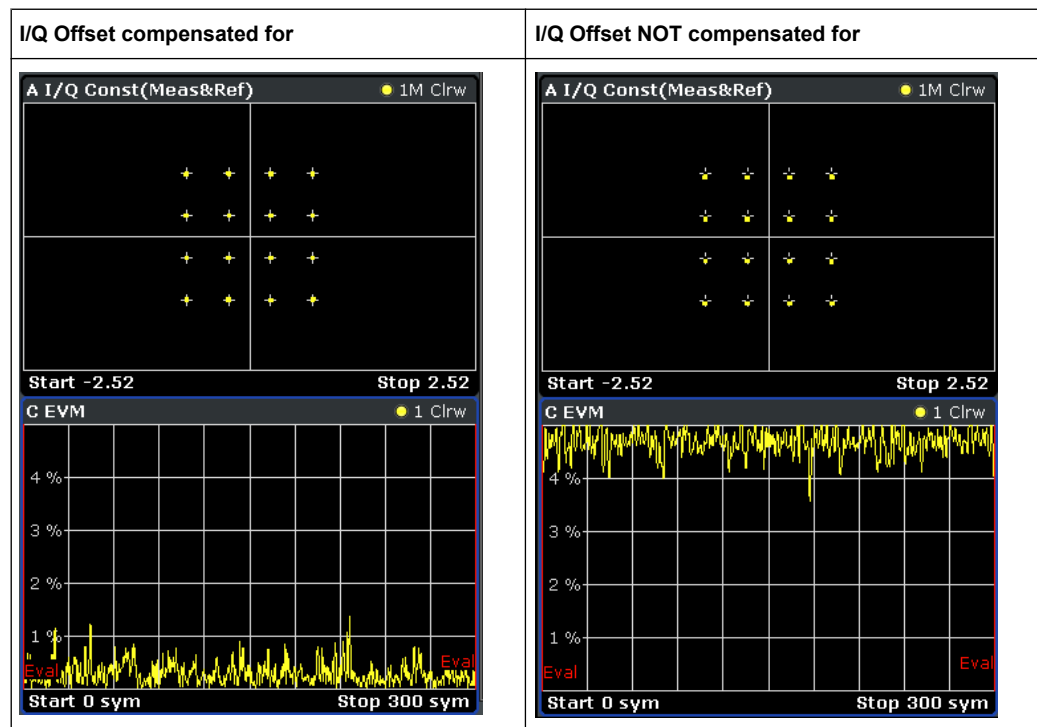
*Fig. 4-55: Effect of an I/Q or origin offset after demodulation and error compensation*

The effect of an I/Q offset in the transmitter is shown in [figure 4-55](#).

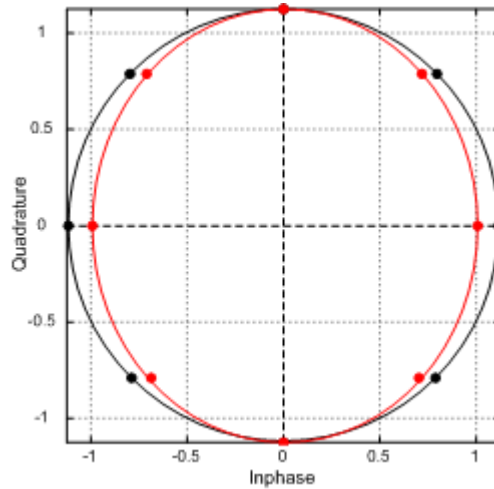
The I/Q offset can be compensated for if the corresponding option is selected in the demodulation settings. In this case, the offset does not affect the EVM.

**Example:**

The following figures compare the results for a compensated I/Q offset of 2.5% and a non-compensated offset.



### Gain Imbalance



**Fig. 4-56: Effect of gain imbalance**

The gain difference in the I and Q channels during signal generation in the transmitter is referred to as gain imbalance. The effect of this error on the constellation diagram and the unit circle are shown in [figure 4-56](#). In the example, the gain in the I channel is slightly reduced which causes a distortion of coordinates in the I direction. The unit circle of the ideal constellation points has an elliptic shape.

The gain imbalance can be compensated for if the corresponding option is selected in the demodulation settings. In this case, the imbalance does not affect the EVM.

Note that the gain imbalance is not estimated (and cannot be compensated for) in a BPSK signal.



#### Preconditions for Gain Imbalance and Quadrature Error measurements

The distortions "gain imbalance" and "quadrature error" can only be measured without ambiguity, if the following two conditions are fulfilled:

- a pattern is detected
- the modulation is a non-differential, non-rotating QAM or PSK

Otherwise, only the measurement parameter "I/Q Imbalance", which is a combination of the gain imbalance and the quadrature error, is significant.

### Quadrature Error

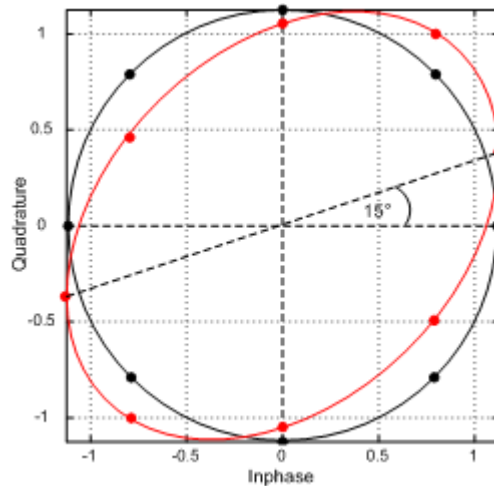


Fig. 4-57: Effect of Quadrature Error

The quadrature error is another modulation error which is shown in [figure 4-57](#).

In this diagram, the I and Q components of the modulated carrier are of identical amplitude but the phase between the two components deviates from 90°.

This error also distorts the coordinates. In the example in [figure 4-57](#), the Q-axis is shifted.

Note that the quadrature error is not estimated (and cannot be compensated for) in a BPSK signal.

### I/Q Imbalance

The effect of quadrature error and gain imbalance are combined to form the error parameter I/Q imbalance.

$$B_{[in]} = \frac{|g_I - g_Q \cdot e^{j\theta}|}{|g_I + g_Q \cdot e^{j\theta}|}$$

where  $g_I$  and  $g_Q$  are the gain of the inphase and the quadrature component and  $\theta$  represents the quadrature error.

The I/Q imbalance can be compensated for if the corresponding option is selected in the demodulation settings. In this case, the I/Q imbalance does not affect the EVM.

Note that the I/Q imbalance is not estimated (and cannot be compensated for) in a BPSK signal.

### Amplitude Droop

The decrease of the signal power over time in the transmitter is referred to amplitude droop.

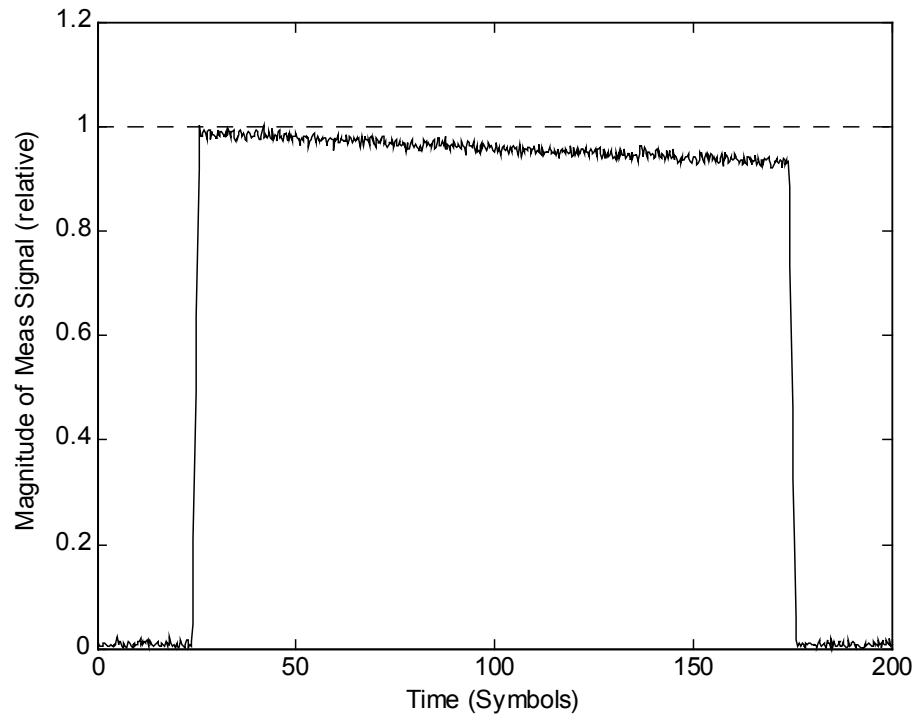


Fig. 4-58: Effect of amplitude droop

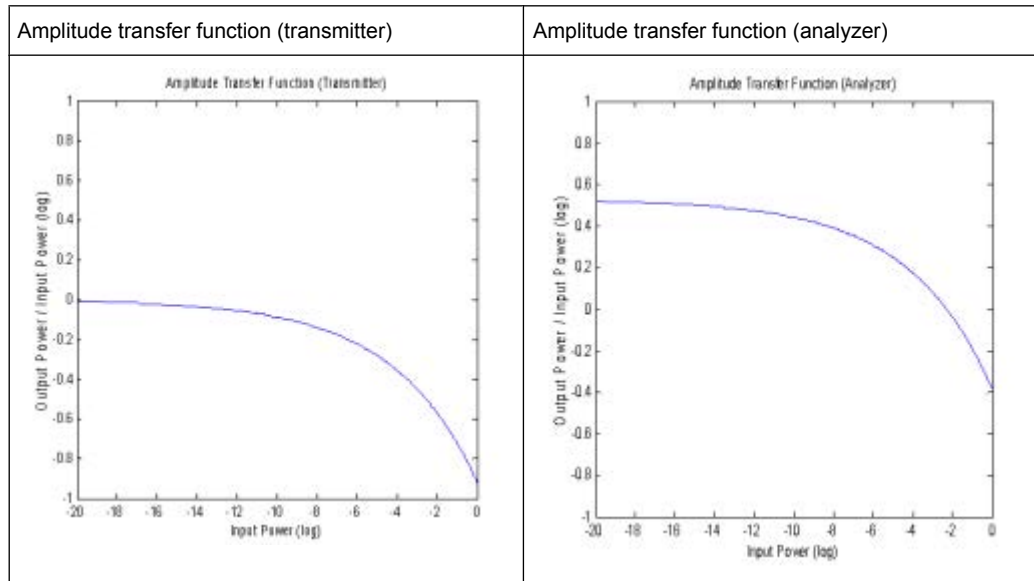
**Gain Distortion**

Table 4-17: Effect of nonlinear amplitude distortions

Nonlinear distortions: amplitude distortion (transmitter)	Amplitude distortion (analyzer)

The effect of nonlinear amplitude distortions on a 64QAM signal are illustrated in table 4-17 (only the first quadrant is shown). The transfer function is level-dependent: the highest effects occur at high input levels while low signal levels are hardly affected. The signal is scaled in the analyzer so that the average square magnitude of the error vector is minimized. The second column shows the signal after scaling.

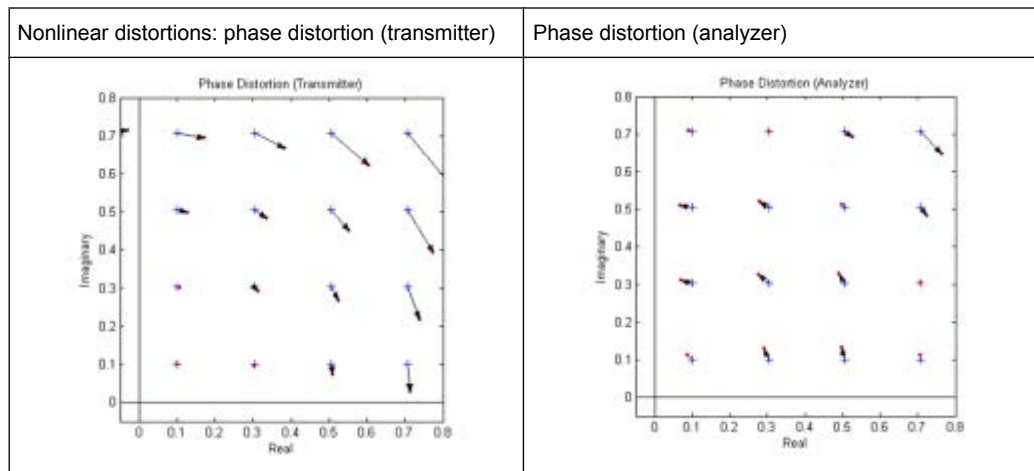
**Table 4-18: Amplitude transfer functions**



A logarithmic display of the amplitude transfer functions is shown in [table 4-18](#). The analyzer trace is shifted against the transmitter trace by this scale factor.

**Phase Distortion**

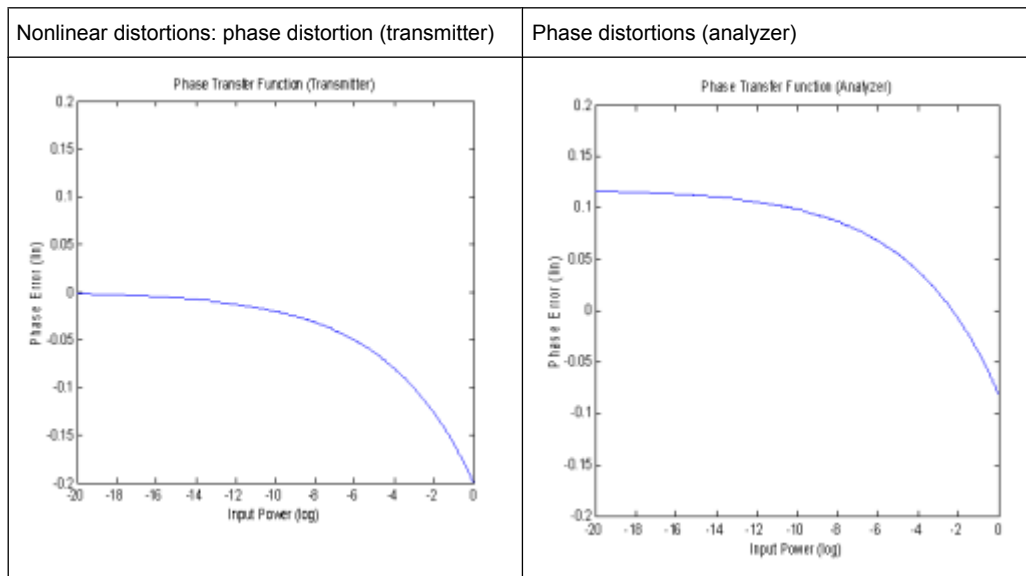
**Table 4-19: Effect of nonlinear phase distortions**



The effect of nonlinear phase distortions on a 64QAM signal is illustrated in [table 4-19](#) (only the first quadrant is shown). The transfer function is level-dependent: the highest effects occur at high input levels while low signal levels are hardly affected. These effects are caused, for instance, by saturation in the transmitter output stages. The signal is scaled in the analyzer so that the average square magnitude of the error vector is minimized. The second column shows the signal after scaling.

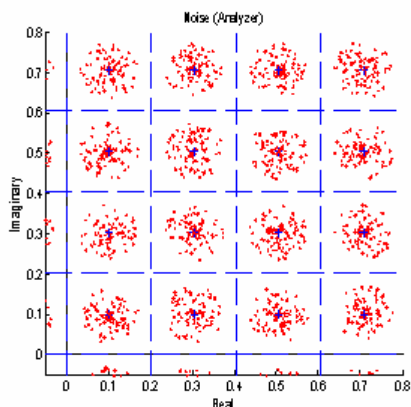


**Table 4-20: Phase transfer functions**



A logarithmic display of the phase transfer functions is shown in [table 4-20](#). The analyzer trace is shifted by the phase described above as against the transmitter trace.

**Noise**



**Fig. 4-59: Additive noise**

A 64QAM signal with additive noise is shown in [figure 4-59](#) (only the first quadrant is shown). The symbol decision thresholds are also shown.

The noise signal forms a "cloud" around the ideal symbol point in the constellation diagram. Exceeding the symbol decision boundaries leads to wrong symbol decisions and increases the bit error rate.

Similar displays are obtained in case of incorrect transmitter filter settings. When an incorrect filter is selected, crosstalk occurs between neighbouring symbol decision points instead of the ISI-free points. The effect increases the more the filtering deviates from actual requirements.

The two effects described cannot be distinguished in the Constellation I/Q diagram but in statistical and spectral analyses of the error signal.

### Channel (transmission) distortion

During transmission, disturbances in the transmission channel may cause distortions in the input signal at the R&S FSW. Such influences are included in the EVM calculation. However, if the ideal (reference) signal can be estimated with sufficient accuracy by the R&S FSW (e.g. using the equalizer), the channel distortions can be compensated for and deducted from the EVM.

## 4.5.2 FSK Modulation

### Signal Model

Frequency shift keying (FSK) involves the encoding of information in the frequency of a transmitted signal. As opposed to other modulation formats such as PSK and QAM, the FSK process is a non-linear transformation of the transmitted data into the transmitted waveform.

A sequence of symbols  $\{s_i\}$  are modulated using a "frequency pulse"  $g(t)$  to form the instantaneous frequency of the transmitted complex baseband waveform, denoted by  $f_{REF}(t)$  and defined as:

$$f_{REF}(t) = h \cdot \sum_i s_i g(t - i \cdot T)$$

where  $f_{Symb} = 1/T$  is the symbol rate and  $h$  is a scaling factor, termed the modulation index. The transmitted (or reference) FSK signal is formed by frequency modulation of the instantaneous frequency:

$$REF(t) = e^{j \cdot 2 \cdot \pi \cdot \int_{-\infty}^t f_{REF}(u) du} = e^{j \cdot \varphi_{REF}(t)}$$

where  $\varphi_{REF}(t)$  denotes the phase of the transmitted waveform. In the VSA application a continuous phase FSK signal is assumed, which is ensured by the integral in the expression for  $REF(t)$ . A graphical depiction of the reference waveform generation is shown below in [figure 4-60](#).

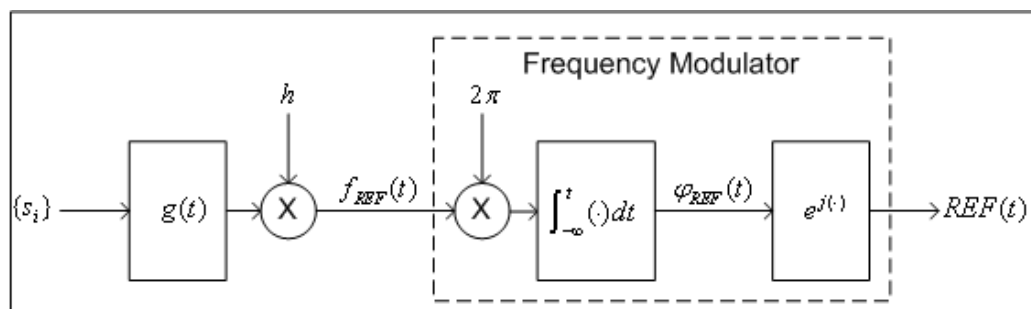


Fig. 4-60: Reference complex baseband FSK signal generation

### Reference Deviation

The transmitted symbols  $\{s_i\}$  are assumed to be chosen from a finite and real-valued constellation of  $M$  values;  $\{\zeta_1, \zeta_2, \dots, \zeta_M\}$ . The maximum absolute constellation point is denoted by  $\zeta_{MAX}$ . The maximum phase contribution of a data symbol is given by:

$$\phi_{MAX} = 2 \cdot \pi \cdot h \cdot \zeta_{MAX} \int_{-\infty}^{\infty} g(t) \cdot dt$$

The reference deviation of the FSK signal is defined as:

$$\Lambda_{REF} = \frac{\phi_{MAX}}{2 \cdot \pi \cdot T} = \frac{1}{T} h \cdot \zeta_{MAX} \int_{-\infty}^{\infty} g(t) \cdot dt$$

In the VSA application the frequency pulse filter is normalized such that:

$$\int_{-\infty}^{\infty} g(t) \cdot dt = \frac{1}{2}$$

The constellation for  $M$  FSK is assumed to be  $\{\pm 1, \pm 3, \dots, \pm(M-1)\}$ , which implies  $\zeta_{MAX} = M-1$ . The expression for the [reference deviation](#) in terms of the modulation index is therefore given by:

$$\Lambda_{REF} = \frac{1}{2} \cdot h \cdot (M-1) \cdot f_{Symb}$$

The above formula provides the necessary calculation for measurement of an FSK signal with known symbol rate and modulation index.

#### Calculation examples:

The GSM standard describes the transmission of binary data using MSK (i.e. 2FSK) modulation with a modulation index of  $h=1/2$  at a symbol rate of 270.8333 KHz. The reference deviation is therefore given by:

$$\Lambda_{REF} = \frac{1}{2} \cdot \left(\frac{1}{2}\right) \cdot (2-1) \cdot (270.8333 \text{ kHz}) = 67.7083 \text{ kHz}$$

The APCO Project 25 standard (phase 2) defines a H-CPM signal (i.e. 4FSK) with a modulation index of  $h=1/3$  and a symbol rate of 6 KHz. The reference deviation is:

$$\Lambda_{REF} = \frac{1}{2} \cdot \left(\frac{1}{3}\right) \cdot (4-1) \cdot (6 \text{ kHz}) = 3 \text{ kHz}$$

#### 4.5.2.1 Error Model

The FSK measurement model used assumes that signal distortions in both the magnitude and phase/frequency are present, as well as additive noise. The measured signal model is expressed as:

$$MEAS(t) = A_{DIST}(t) \cdot e^{j\varphi_{DIST}(t)} + n(t)$$

with

$n(t)$  is a disturbing additive noise process of unknown power,

$A_{DIST}(t)$  is the distorted magnitude model and

$\varphi^{DIST(t)}$  is the distorted phase model.

The magnitude model is given by:

$$A_{DIST}(t) = K \cdot e^{-\alpha t}$$

with

$K$  is a constant scaling factor which can be interpreted as the system gain and

$\alpha$  is the amplitude droop in Nepers per second.

The phase model is given by:

$$\varphi_{DIST}(t) = B \cdot \varphi_{REF}(t - \tau) + C \cdot t + \frac{1}{2} D \cdot t^2 + \phi$$

with

$B$  is a scaling factor which results in a reference deviation error,

$C$  is a carrier frequency offset in radians per second,

$D$  is a frequency drift in radians per second per second,

$\tau$  is a timing offset in seconds and

$\phi$  is a phase offset in radians.

For the above phase model, an equivalent frequency distortion model may be expressed as:

$$f_{DIST}(t) = B \cdot f_{REF}(t - \tau) + f_0 + f_d \cdot t$$

with

$B$  is the scaling factor which results in a reference deviation error,

$f_0 = C / (2 \cdot \pi)$  is a carrier frequency offset in Hz,

$f_d = D / (2 \cdot \pi)$  is a frequency drift in Hz per second and

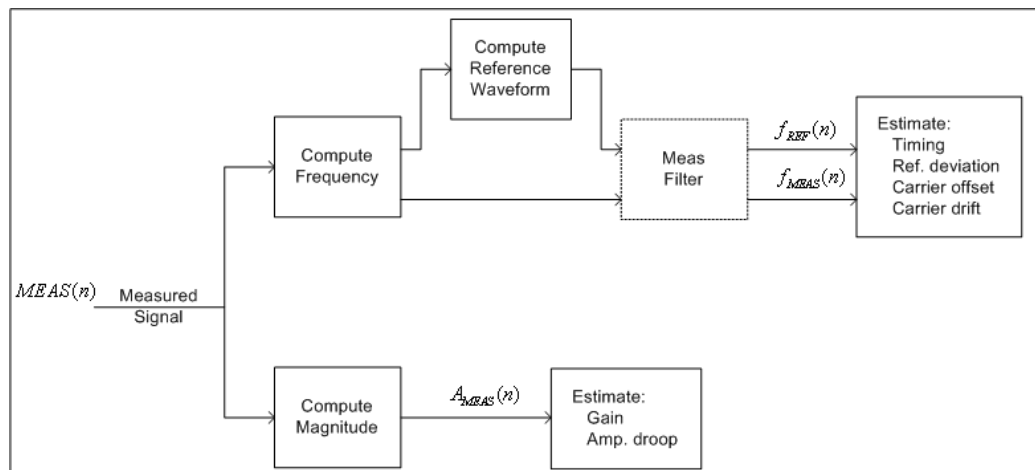
$\tau$  is the timing offset in seconds.

The measured signal model in terms of the instantaneous frequency and all distortion parameters is given by:

$$MEAS(t) = K \cdot e^{-\alpha t} \cdot e^{j\phi} \cdot e^{j2\pi \left[ B \cdot \int_{-\infty}^t f_{REF}(u - \tau) du + f_0 t + \frac{1}{2} f_d t^2 \right]} + n(t)$$

### 4.5.2.2 Estimation

The estimation of the distortion parameters listed previously is performed separately for the magnitude and phase/frequency distortions, as illustrated in [figure 4-61](#). It is noted that the estimation of the timing offset is performed only on the frequency of the signal, as the reference magnitude is assumed to be constant over the estimation range. For details on the estimation range, see ["Estimation ranges"](#) on page 97.



**Fig. 4-61: FSK Estimation Strategy**

In [figure 4-61](#)  $MEAS(n)$  denotes the sampled (complex baseband) measured signal waveform. The magnitude samples are denoted  $A_{MEAS}(n)$ , while the instantaneous frequency samples of the measured and reference signals are denoted by  $f_{MEAS}(n)$  and  $f_{REF}(n)$  respectively. The dashed outline of the "Meas Filter" block indicates that this operation is optionally (de-) activated based on the corresponding user settings (see ["Type"](#) on page 180 ).

For the estimation of the magnitude parameters, the following least-squares criterion is minimized:

$$C_{MAG}(K, \alpha) = \sum_n |A_{MEAS}(n) - K \cdot e^{-\alpha \cdot n \cdot T_E}|^2$$

with respect to the model parameters  $K$  and  $\alpha$ , where  $T_E$  denotes the sampling period used for estimation (see ["Estimation Points/Sym"](#) on page 177).

For estimation of the frequency parameters, the following least-squares criterion is minimized:

$$C_{FREQ}(B, f_0, f_d, \tau) = \sum_n |f_{MEAS}(n) - [B \cdot f_{REF}(n; \tau) + f_0 + f_d \cdot n \cdot T_E]|^2$$

with respect to the model parameters  $B$ ,  $f_0$ ,  $f_d$  and  $\tau$ . The term denotes the reference instantaneous frequency with a (possibly fractional) delay of samples.



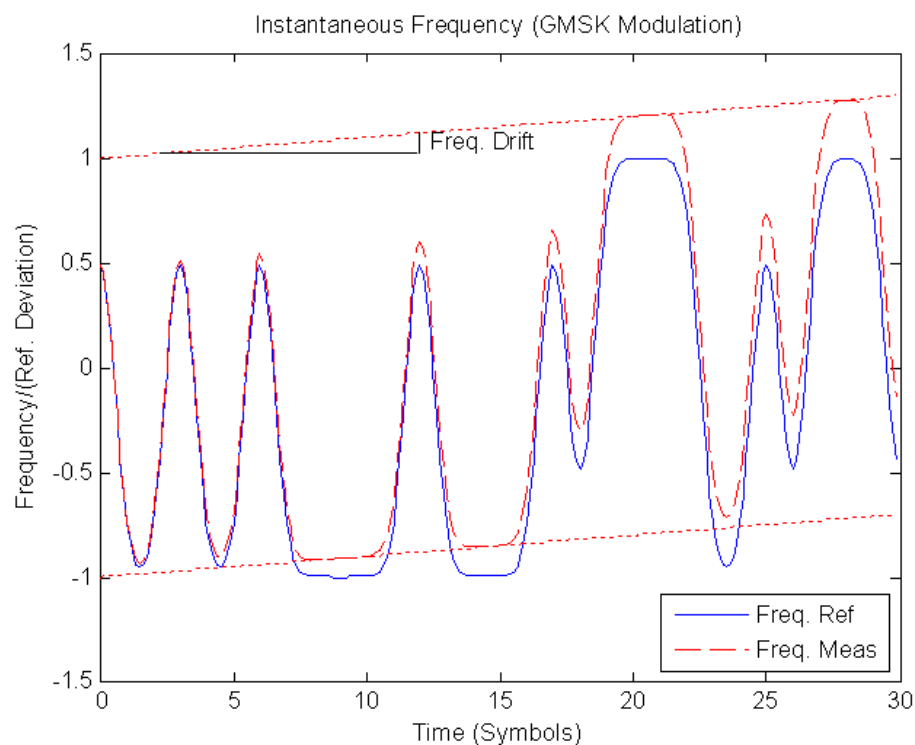
For FSK modulation the default sampling period used for estimation is the capture sampling period.

#### 4.5.2.3 Modulation Errors

A 2FSK signal is generated using a GMSK frequency pulse. Examples of carrier drift and reference deviation are shown in [figure 4-62](#) and [figure 4-63](#), respectively.

##### Carrier frequency drift

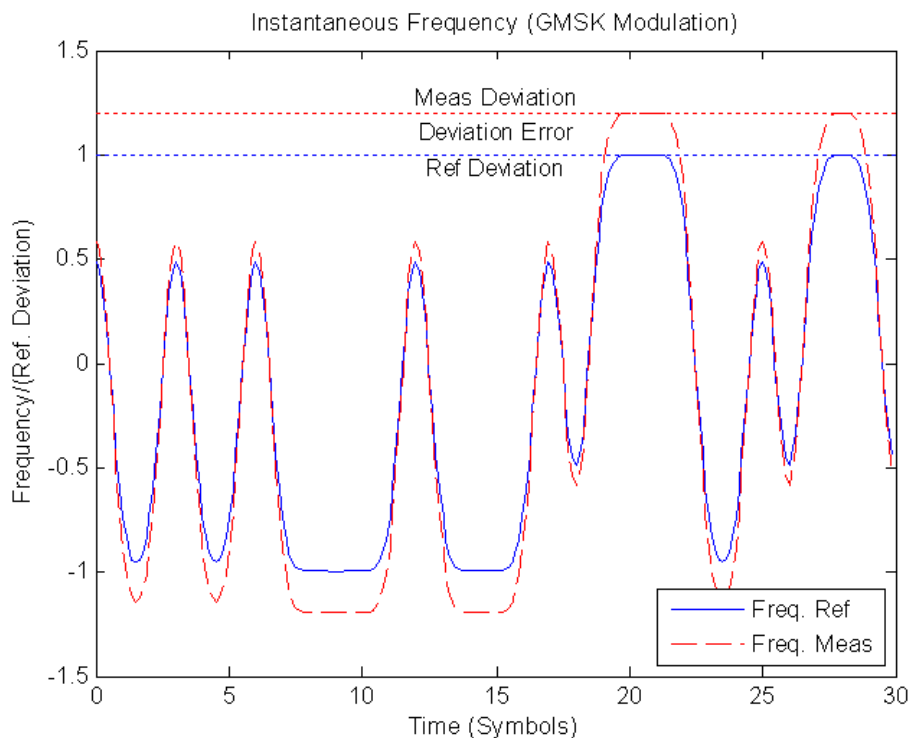
A carrier frequency drift is modeled as a linear change in the carrier frequency with respect to time. The effect of carrier drift on the instantaneous frequency of an FSK signal is illustrated in [figure 4-62](#).



**Fig. 4-62:** The reference and distorted instantaneous frequency of a GMSK signal with a carrier frequency drift

##### FSK deviation error

The FSK deviation error is the difference between the measured frequency deviation and the reference frequency deviation as entered by the user (see "[FSK Ref Deviation \(FSK only\)](#)" on page 129). The evidence of a deviation error in the instantaneous frequency of an FSK signal is demonstrated in [figure 4-63](#).



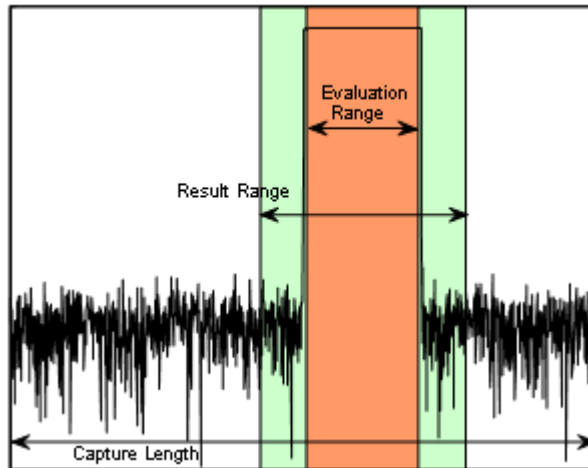
**Fig. 4-63:** The reference and measured instantaneous frequency of a GMSK signal with reference deviation error

## 4.6 Measurement Ranges

The VSA application contains three measurement ranges that need to be set by the user:

- **Capture Buffer Length**  
 The length of the capture buffer specifies how many data points are captured during a single VSA measurement.  
 For example, if you want to measure a bursted signal, it is recommended that you make the capture length long enough to ensure that in each capture buffer at least one entire burst is included.
- **Result Range**  
 The result range defines the symbols from the capture buffer that are to be demodulated and analyzed together.  
 For example, bursted signals have intervals between the bursts that are not of interest when analyzing peaks or overshoots. Thus, the result range usually coincides with the range of the capture buffer in which the burst is located.
- **Evaluation Range**  
 The evaluation range defines the symbols from the result range that are to be included in the evaluation of specific parameters, e.g. error vectors.

For example, while you may want to display the ramps of a burst and thus include them in the result range, they do not contribute to the error vectors or power levels. Thus, you would not include them in the evaluation range.



*Fig. 4-64: Schematic overview of Capture Length, Result Range, and Evaluation Range*

The determined result and evaluation ranges are included in the result displays (where useful) to visualize the basis of the displayed values and traces.

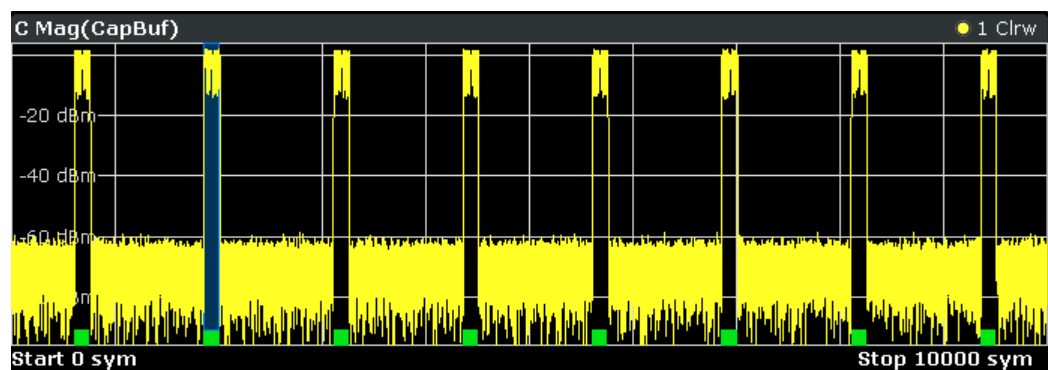
#### 4.6.1 Result Range

The result range defines the symbols from the capture buffer that are to be demodulated and analyzed together.

In some cases, the data in the capture buffer contains parts that are not relevant for the evaluation task at hand. Thus, you can exclude them from the result range (see [chapter 5.8, "Result Range Configuration"](#), on page 169).

##### Result range display

The result ranges are indicated by green bars along the time axis of the capture buffer result diagrams.



*Fig. 4-65: Result ranges for a burst signal*



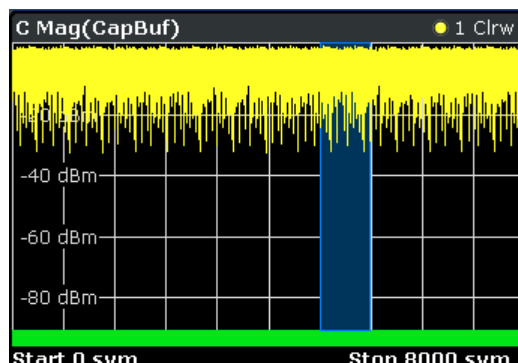
Result displays whose source is not the capture buffer are based on a single result range, such as the "EVM vs. Time" display or the data in the "Current" column of the Result Summary. In this case, you can use the capture buffer display to navigate through the available result ranges ([Select Result Rng](#) softkey), and analyze the individual result ranges in separate windows. The currently displayed result range is indicated by a blue bar in the capture buffer display.

You can change the position of the result range quickly and easily by dragging the blue bar representing the result range to a different position in the capture buffer.

### Continuous and discrete result ranges

Depending on the type of signal and your result range definition, the result ranges may be continuous or discrete. Bursted signals commonly have several discrete result ranges at the bursts, with intervals during the noise periods which should not be included in the results (see [figure 4-65](#)).

Continuous signals, on the other hand, have result ranges that cover the entire or a specific part of the capture buffer without intervals.



*Fig. 4-66: Result ranges for a continuous signal*

### Result Range Length

The result range length is defined by the number of symbols that are to be demodulated. All traces over time are displayed over the result range. For example, if you have a burst of 100 symbols and you define the result length as 200 symbols, you can examine the burst ramps in detail (by selecting the alignment "Burst - Center").

The maximum result length depends on the CPU board (indicated in "SETUP > System Info > Hardware Info"):

FMR-7: 10000 symbols

FMR-9: 20000 symbols

### Result Range Alignment

By defining the number of the symbol which marks the beginning of the alignment reference source (burst, capture buffer or pattern), you can define an offset of the x-axis (in addition to the one defined for the signal structure, see ["Offset"](#) on page 133).

For example, if you align the result to the center of the pattern and set the "Symbol Number at Pattern Start" to "0", you can easily find the pattern start in the EVM measurement simply by moving a marker to the symbol number "0".



When you define the "Symbol Number at <Reference> Start" remember to take the offset defined for the signal structure into consideration (see "Offset" on page 133). If you define an offset of the pattern with respect to the useful part of the burst in the signal description and align the result to the pattern, the "Symbol Number at Pattern Start" refers to the first symbol of the useful part of the burst, not the first symbol of the pattern.

### Run-In / Run-Out Time

The parameter Run-In/-Out can be used to influence the range over which the EVM is minimized. The (internal) synchronization range is the overlapping area of the result range and the burst excluding its Run-In/-Out areas. Hence, this parameter also allows for demodulation of bursts with mixed modulations, e.g. Bluetooth, because it can be used to explicitly exclude symbols from influencing the synchronization.

### Useful length

The burst excluding its Run-In/-Out areas is sometimes referred to as the "useful part". The minimum length of the useful part (= Min Length - Run-In - Run-Out) must be  $\geq 10$ .

## 4.6.2 Evaluation Range

In some scenarios, the result range contains symbols that are not supposed to be considered for the EVM or other calculated parameters that are displayed in the Result Summary.

For example, while you may want to display the ramps of a burst and thus include them in the result range, they do not contribute to the error vectors or power levels. Thus, you would not include them in the evaluation range. (See also [chapter 8.3.4, "Evaluating the Rising and Falling Edges"](#), on page 233).

The evaluation range is always equal to or smaller than the result range and defines:

- The range over which traces that do not have a time axis are displayed, e.g. polar diagrams
- The range over which the following parameters are calculated for the Result Summary: EVM, MER, Phase Error, Magnitude Error, Power

### Evaluation range display

In all displays over time, except for capture buffer displays, the evaluation range is indicated by red lines.

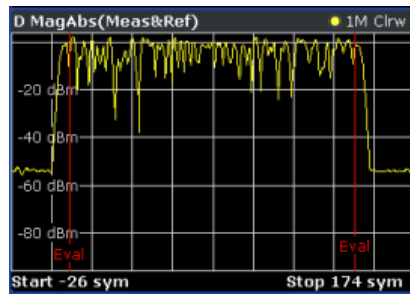


Fig. 4-67: Evaluation lines in absolute magnitude diagram

In symbol tables, the evaluated symbols are indicated by red square brackets.

D Symbol Table (Hexadecimal)										
	+	1	+	3	+	5	+	7	+	9
0	1E	1E	0E	0E	05	15	1E	15	08	02
10	12	17	12	1D	18	03	13	14	13	1A
20	1D	08	12	03	07	01	0F	0D	13	08
30	0E	1E	03	1F	18	07	17	18	17	06
40	08	04	14	1D	14	0F	07	19	16	05
50	09	03	11	16	15	18	13	02	04	00
60	08	08	18	09	19	0A	18	0D	1D	06
70	1C	11	08	00	12	00	12	12	00	00
80	00	12	12	12	00	00	12	00	00	12
90	12	00	12	00	00	00	00	00	00	00
100	12	00	12	12	0A	1A	0F	1B	04	..

In other result displays that are based on the evaluation range only, two red vertical lines are displayed in the diagram header to indicate a limited evaluation basis.

B Result Summary

## 4.7 Display Points vs Estimation Points per Symbol

### Estimation points per symbol

During synchronization, the measurement signal is matched to the reference signal and various signal parameters are calculated, as well as the optional equalizer. You can define how many sample points are used for this calculation at each symbol. Typically, this is one point per symbol (= **symbol rate**) or a factor of 4 (= **sample rate**).

### Display points per symbol

The number of points per symbol used for calculation may vary from the number of points used to display the results of the calculation. If more points per symbol are selected than the defined sample rate, the additional points are interpolated for the display. The more points are displayed per symbol, the more detailed the trace becomes, as illustrated in [figure 4-68](#).

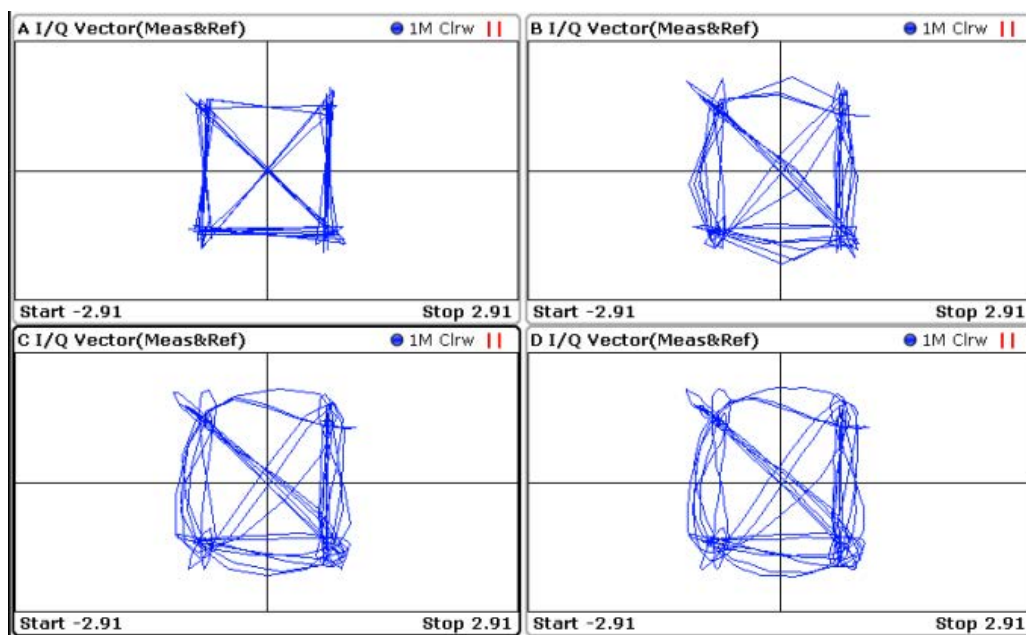


Fig. 4-68: Result display with different numbers of points per symbol: window A = 1; window B = 2; window C = 4; window D = 16;



The displayed points per symbol also determine how many values are returned when the trace data is queried by a remote command (see [TRACe<n> \[ :DATA \]](#) on page 363).

For results based on the **capture buffer**, one display point is displayed for each sample taken, i.e. the display points per symbol are always identical to the sample rate.

For the "Result Summary", the number of display points corresponds to the estimation points per symbol. (By default, 1 for QAM and PSK modulated signals and the sample rate for MSK and FSK modulated signals.) This value also controls which samples are considered for the peak and RMS values and the power result.

For all other result displays, the default number of displayed points per symbol is identical to the sample rate.

## 4.8 Known Data Files - Dependencies and Restrictions

For various vector signal analysis functions the measured signal is compared to a defined ideal reference signal. The more precise the reference signal, the more precise the results become. In the best case, the possible data sequences within the signal to analyze are known in advance and can be used to compare the measured data to. This is similar to defining a pattern for the entire result range. Thus, a falsely estimated reference signal (due to false symbol decisions) is avoided and does not influence the error calculation.

You can load xml files containing the possible sequences to the VSA application and use them to compare the measured data to. In particular, you can use known data for the following functions:

- Fine synchronization during the demodulation process (see [figure 4-43](#) and "[Fine Synchronization](#)" on page 178)
- Calculation of the Bit Error Rate (BER), see [chapter 3.2.23, "Bit Error Rate \(BER\)"](#), on page 42

For details on working with Known Data files see [chapter 7.2.3, "How to Manage Known Data Files"](#), on page 208.

The syntax for Known Data files is described in [chapter A.4, "Known Data File Syntax Description"](#), on page 408.

When you use Known Data files as a reference, some dependencies to other settings and restrictions for other functions apply.

### Modulation Order

The "Modulation Order" selected in the "Modulation" settings in the VSA application must correspond to the modulation order value specified in the xml file (<ModulationOrder> element).

### Demodulation

Demodulation using synchronization to the Known Data may increase the measurement duration, as each detected symbol must be compared to each possible sequence in the data file.

### Result Length

The "Result Length" specified in the "Result Range" dialog box in the VSA application must be identical to the length of the specified symbol sequences in the xml file (<Result-Length> element).

### Result Range Alignment

- **Bursted signals**

When you align the result range to a bursted signal, due to the uncertainty of the burst search, the determined result range might start up to 2 symbols before or after the actual burst. However, an offset of only one symbol has the effect that none of the predefined symbol sequences in the Known Data file will be found. To avoid this, try one of the following:

- Align the result range to a pattern instead of the burst.
- Use a precise external trigger and align the result range to the capture buffer. This requires a very precise trigger timing, otherwise the result range start may be incorrect again.

- **Continuous signals**

For continuous signals without a pattern, the result range is aligned randomly. Thus, a very large number of possible sequences must be predefined.

Use a precise external trigger and align the result range to the capture buffer. This requires a very precise trigger timing, otherwise the result range start may be incorrect again.

## 4.9 VSA in MSRA Operating Mode

The R&S FSW VSA application can also be used to analyze data in MSRA operating mode.

In MSRA operating mode, only the MSRA Master actually captures data; the MSRA applications receive an extract of the captured data for analysis, referred to as the **application data**. For the R&S FSW VSA application in MSRA operating mode, the application data range is defined by the same settings used to define the signal capture in Signal and Spectrum Analyzer mode. In addition, a capture offset can be defined, i.e. an offset from the start of the captured data to the start of the application data for vector signal analysis. The "Capture Buffer" displays show the application data of the VSA application in MSRA mode.

### Data coverage for each active application

Generally, if a signal contains multiple data channels for multiple standards, separate applications are used to analyze each data channel. Thus, it is of interest to know which application is analyzing which data channel. The MSRA Master display indicates the data covered by each application, restricted to the channel bandwidth used by the corresponding standard, by vertical blue lines labeled with the application name. Since the VSA application supports several standards and the standard used by the currently analyzed data is not known, the "Symbol Rate" defined in the "Signal Description" settings is used to approximate the channel bandwidth.

### Analysis interval

However, the individual result displays of the application need not analyze the complete data range. The data range that is actually analyzed by the individual result display is referred to as the **analysis interval**.

In the R&S FSW VSA application the analysis interval is automatically determined according to the evaluation range or result range settings, as in Signal and Spectrum Analyzer mode. The currently used analysis interval (in seconds, related to capture buffer start) is indicated in the window header for each result display.



### Exception: Equalizer

In the "Equalizer" displays do not indicate the analysis interval in MSRA mode.

---

For details on the MSRA operating mode see the R&S FSW MSRA User Manual.

## 5 Configuration

Using the VSA application you can perform vector signal analysis measurements using predefined standard setting files, or independently of digital standards using user-defined measurement settings. Such settings can be stored for recurrent use.

Thus, configuring VSA measurements requires one of the following tasks:

- Selecting an existing standard settings file and, if necessary, adapting the measurement settings to your specific requirements.
- Configuring the measurement settings and, if necessary, storing the settings in a file.

### VSA application

VSA measurements require a special application on the R&S FSW, which you activate using the MODE key on the front panel.

When you switch the application of a measurement channel to VSA the first time, a set of parameters is passed on from the currently active application (see [chapter 5.1, "Default Settings for Vector Signal Analysis"](#), on page 120). After initial setup, the parameters for the measurement channel are stored upon exiting and restored upon re-entering the channel. Thus, you can switch between applications quickly and easily.

When you activate a measurement channel for the VSA application, a VSA measurement for the input signal is started automatically with the default configuration. The "VSA" menu is displayed and provides access to the most important configuration functions.




### Automatic refresh of preview and visualization in dialog boxes after configuration changes

The R&S FSW supports you in finding the correct measurement settings quickly and easily - after each change in settings in dialog boxes, the preview and visualization areas are updated immediately and automatically to reflect the changes. Thus, you can see if the setting is appropriate or not before accepting the changes.



### Importing and Exporting I/Q Data

The I/Q data to be evaluated in VSA can not only be measured by the VSA application itself, it can also be imported to the application, provided it has the correct format. Furthermore, the evaluated I/Q data from the VSA application can be exported for further analysis in external applications.

The import and export functions are available in the "Save/Recall" menu which is displayed when you select the  "Save" or  "Open" icon in the toolbar.

For details on importing and exporting I/Q data see the R&S FSW User Manual.

- [Default Settings for Vector Signal Analysis](#)..... 120
- [Configuration According to Digital Standards](#)..... 121
- [Configuration Overview](#)..... 123
- [Signal Description](#)..... 126
- [Input and Frontend Settings](#)..... 134

• <a href="#">Signal Capture</a> .....	151
• <a href="#">Burst and Pattern Configuration</a> .....	160
• <a href="#">Result Range Configuration</a> .....	169
• <a href="#">Demodulation Settings</a> .....	171
• <a href="#">Measurement Filter Settings</a> .....	179
• <a href="#">Evaluation Range Configuration</a> .....	181
• <a href="#">Adjusting Settings Automatically</a> .....	183

## 5.1 Default Settings for Vector Signal Analysis

When you switch the application of a measurement channel to VSA the first time, a set of parameters is passed on from the currently active application:

- center frequency and frequency offset
- reference level and reference level offset
- attenuation
- signal source and digital I/Q input settings
- input coupling
- YIG filter state

After initial setup, the parameters for the measurement channel are stored upon exiting and restored upon re-entering the channel. Thus, you can switch between applications quickly and easily.

Apart from these settings, the following default settings are activated directly after a measurement channel has been set to VSA, or after a [Preset Channel](#):

**Table 5-1: Default settings for VSA channels**

Parameter	Value
Digital standard	3G_WCDMA
Sweep mode	CONTINUOUS
Trigger settings	FREE RUN
Trigger offset	0
Modulation	QPSK, WCDMA mapping
Transmit filter	RRC, $\alpha=0.22$
Measurement filter	= Transmit filter
Signal type	Continuous, no pattern
Symbol rate	3.84 MHz
Sample rate	4* Symbol rate (=15.36 MHz)
Capture length	8000 symbols
Usable I/Q Bandwidth	12.228 MHz
Result length	800 symbols



Parameter	Value
Result Range alignment	Left at capture buffer start
Evaluation range	Entire result range
Demodulation	Compensation for I/Q offset and amplitude droop Estimation points per symbol: auto (1)
Evaluations	Window 1: Constellation I/Q (Meas & Ref) Window 2: Result Summary Window 3: Magnitude absolute (Capture buffer) Window 4: Symbol table (hexadecimal)
Display points per symbol	= Sample rate (4)

Apart from the "Preset Channel" function (see ["Preset Channel"](#) on page 125), the following functions are available to restore factory settings to the VSA application (via soft-keys in the MEAS menu):

<a href="#">Restore Factory Settings</a> .....	121
L <a href="#">Restore Standard Files</a> .....	121
L <a href="#">Restore Pattern Files</a> .....	121

### Restore Factory Settings

Opens a submenu that allows you to restore all standards and pattern settings on the instrument to the values predefined by Rohde & Schwarz available at the time of delivery.

#### Restore Standard Files ← Restore Factory Settings

Restores the standards predefined by Rohde & Schwarz available at the time of delivery.

Note that this function will overwrite customized standards that have the same name as predefined standards.

SCPI command:

[\[SENSe:\] DDEMod:FACTory\[:VALue\]](#) on page 265

#### Restore Pattern Files ← Restore Factory Settings

Restores the pattern files predefined by Rohde&Schwarz available at the time of delivery.

SCPI command:

[\[SENSe:\] DDEMod:FACTory\[:VALue\]](#) on page 265

## 5.2 Configuration According to Digital Standards

Various predefined settings files for common digital standards are provided for use with the VSA application. In addition, you can create your own settings files for user-specific measurements.

For an overview of predefined standards and settings see [chapter A.1, "Predefined Standards and Settings"](#), on page 398. For detailed instructions see [chapter 7.1, "How to Perform VSA According to Digital Standards"](#), on page 201

Digital standard settings are available via the "Digital Standards" softkey in the MEAS menu.

Digital Standards.....	122
L Selecting the Storage Location - Drive/ Path/ Files.....	122
L New Folder.....	122
L File Name.....	122
L Comment.....	122
L Load Standard.....	122
L Save Standard.....	123
L Save Standard.....	123
L Delete Standard.....	123
L Restore Standard Files.....	123

### Digital Standards

Opens a file selection dialog to manage predefined measurement settings for conventional mobile radio standards.

#### Selecting the Storage Location - Drive/ Path/ Files ← Digital Standards

Select the storage location of the settings file on the instrument or an external drive.

The "Drive" indicates the internal (C:) or any connected external drives (e.g. a USB storage device).

The "Path" contains the drive and the complete file path to the currently selected folder.

The "Files" list contains all subfolders and files of the currently selected path.

The default storage location for the standards files is: C:/FSW/vsa/Standards or (for user-defined standards) C:/FSW/user/vsa/Standards.

#### New Folder ← Digital Standards

Creates a new folder in the file system in which you can save the settings file.

#### File Name ← Digital Standards

Contain the name of the data file without the path or extension.

By default, the name of a settings file consists of a base name followed by an underscore. Multiple files with the same base name are extended by three numbers, e.g.

limit\_lines\_005.

For details on the file name and location see the "Data Management" topic in the R&S FSW User Manual.

#### Comment ← Digital Standards

An optional description for the data file. A maximum of 60 characters can be displayed.

SCPI command:

[SENSe:] DDEMod:STANdard:COMMeNt on page 266

#### Load Standard ← Digital Standards

Loads the selected measurement settings file.

**Note:** When you load a standard, the usage of a known data file, if available, is automatically deactivated.

SCPI command:

[SENSe:] DDEMod:PRESet [:STANdard] on page 265

#### Save Standard ← Digital Standards

Saves the current measurement settings for a specific standard as a file with the defined name.

SCPI command:

[SENSe:] DDEMod:STANdard:SAVE on page 267

#### Save Standard ← Digital Standards

Saves the current measurement settings for a specific standard as a file with the defined name.

SCPI command:

[SENSe:] DDEMod:STANdard:SAVE on page 267

#### Delete Standard ← Digital Standards

Deletes the selected standard. Standards predefined by Rohde & Schwarz can also be deleted. A confirmation query is displayed to avoid unintentional deletion of the standard.

**Note:** Restoring predefined standard files. The standards predefined by Rohde & Schwarz available at the time of delivery can be restored using the "Restore Standards" softkey.

(See "Restore Standard Files" on page 121).

SCPI command:

[SENSe:] DDEMod:STANdard:DELeTe on page 266

#### Restore Standard Files ← Digital Standards

Restores the standards predefined by Rohde & Schwarz available at the time of delivery.

Note that this function will overwrite customized standards that have the same name as predefined standards.

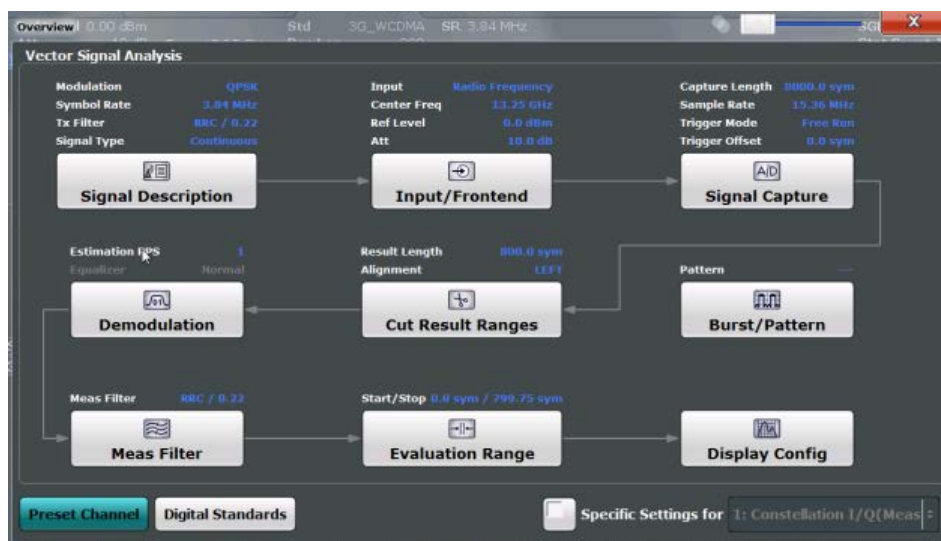
SCPI command:

[SENSe:] DDEMod:FACTory[:VALue] on page 265

## 5.3 Configuration Overview



Throughout the measurement channel configuration, an overview of the most important currently defined settings is provided in the "Overview". The "Overview" is displayed when you select the "Overview" icon, which is available at the bottom of all softkey menus.



In addition to the main measurement settings, the "Overview" provides quick access to the main settings dialog boxes. The individual configuration steps are displayed in the order of the data flow. Thus, you can easily configure an entire measurement channel from input over processing to output and analysis by stepping through the dialog boxes as indicated in the "Overview".

In particular, the "Overview" provides quick access to the following configuration dialog boxes (listed in the recommended order of processing):

1. Signal Description  
See [chapter 5.4, "Signal Description"](#), on page 126
2. Input and Frontend Settings  
See [chapter 5.5, "Input and Frontend Settings"](#), on page 134
3. Signal Capture (including Triggering)  
See [chapter 5.6, "Signal Capture"](#), on page 151
4. Burst/Pattern Configuration  
See [chapter 5.7, "Burst and Pattern Configuration"](#), on page 160
5. Result Range Definition  
See [chapter 5.8, "Result Range Configuration"](#), on page 169
6. Demodulation Settings  
See [chapter 5.9, "Demodulation Settings"](#), on page 171
7. Measurement Filter Settings  
See [chapter 5.10, "Measurement Filter Settings"](#), on page 179
8. Evaluation Range Definition  
See [chapter 5.11, "Evaluation Range Configuration"](#), on page 181
9. Display Configuration  
The "Display Config" button is only available in the general overview, not in the window-specific overview (see ["Specifics for"](#) on page 125).

See [chapter 6.5, "Display and Window Configuration"](#), on page 196

#### 10. Analysis

See [chapter 6, "Analysis"](#), on page 185

#### To configure settings

- ▶ Select any button in the "Overview" to open the corresponding dialog box. Select a setting in the channel bar (at the top of the measurement channel tab) to change a specific setting.

For step-by-step instructions on configuring VSA measurements, see [chapter 7, "How to Perform Vector Signal Analysis"](#), on page 201.

#### Preset Channel

Select the "Preset Channel" button in the lower lefthand corner of the "Overview" to restore all measurement settings **in the current channel** to their default values.

Note that the PRESET key on the front panel restores all measurements **in all measurement channels** on the R&S FSW to their default values!

See [chapter 5.1, "Default Settings for Vector Signal Analysis"](#), on page 120 for details.

SCPI command:

`SYSTem:PRESet:CHANnel[:EXECute]` on page 264

#### Specifics for

The measurement channel may contain several windows for different results. Thus, the settings indicated in the "Overview" and configured in the dialog boxes vary depending on the selected window.

Select an active window from the "Specifics for" selection list that is displayed in the "Overview" and in all window-specific configuration dialog boxes.

Enable the "Specifics for" option.

The "Overview" and dialog boxes are updated to indicate the settings for the selected window.

The indicated data flow is updated for the selected data source.

If the "Specifics for" option is not enabled, the overview displays the default data flow and the general settings independantly of the selected window.

**Note:** The "Display Config" button is only available in the general overview, not in the window-specific overview.

#### Digital Standards

Opens a file selection dialog to manage predefined measurement settings for conventional mobile radio standards. See [chapter 5.2, "Configuration According to Digital Standards"](#), on page 121

## 5.4 Signal Description

The signal description provides information on the expected input signal, which optimizes burst and pattern detection and allows for the application to calculate an ideal reference signal. The signal description consists of information on the used modulation and on the signal's structure.

- [Modulation](#).....126
- [Signal Structure](#).....130
- [Known Data](#).....133

### 5.4.1 Modulation

The "Modulation" settings contain modulation and transmit filter settings. A live preview of the Constellation I/Q trace using the currently defined settings is displayed at the bottom of the dialog box to visualize the changes to the settings. The preview area is not editable directly.

The modulation settings vary depending on the selected modulation type; in particular, FSK modulation provides some additional settings.

The "Modulation" settings are displayed when you select the "Signal Description" button in the "Overview" or the "Signal Description" softkey in the main VSA menu.

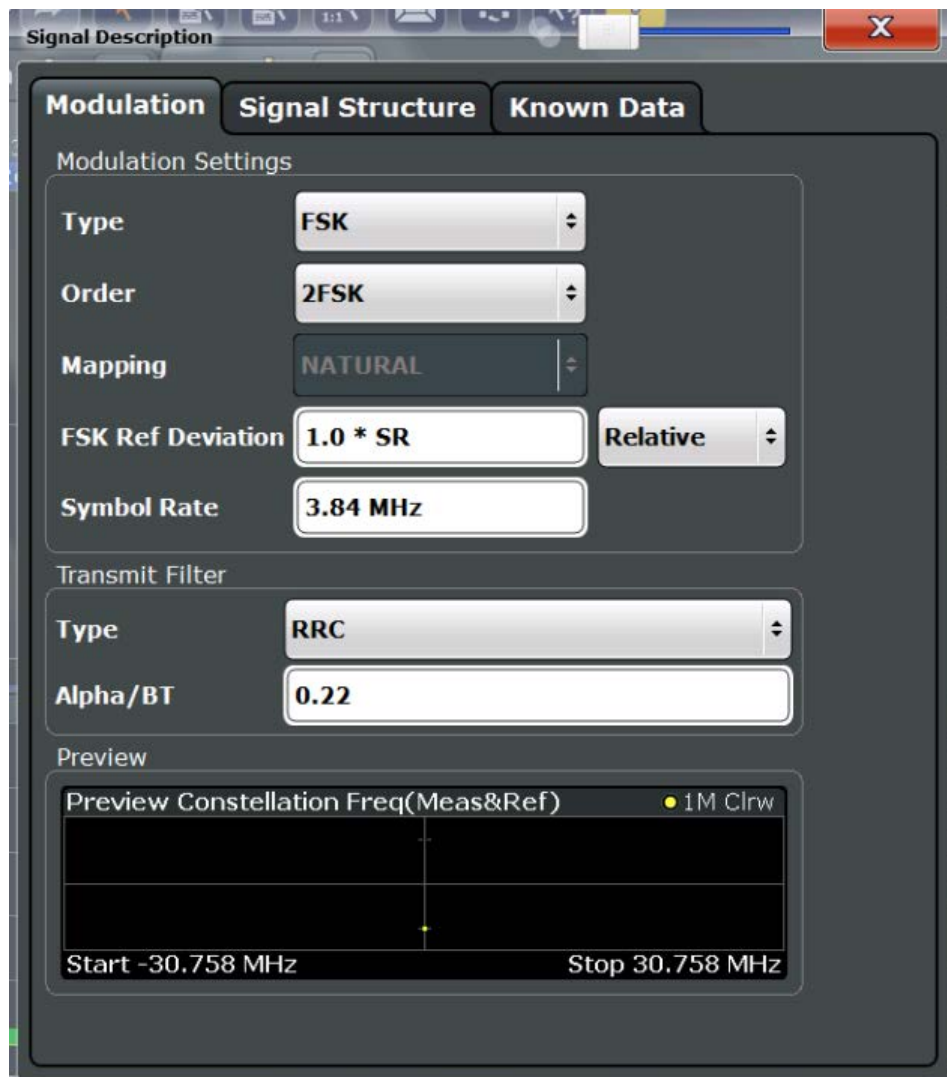


Fig. 5-1: Signal modulation settings for FSK modulation

Modulation Type.....	127
└ Load User Modulation.....	128
Modulation Order.....	128
FSK Ref Deviation (FSK only).....	129
Modulation Mapping.....	129
Symbol Rate.....	129
Transmit Filter Type.....	130
└ Load User Filter.....	130
Alpha/BT.....	130

### Modulation Type

Defines the modulation type of the vector signal. The following types are available:

- PSK
- MSK
- QAM

- FSK
- ASK
- APSK
- User Modulation  
Uses the selected user-defined modulation loaded from a file.

For more information on these modulation types see [chapter 4.3, "Symbol Mapping"](#), on page 63.

SCPI command:

[SENSe:] DDEMod: FORMat on page 270

### Load User Modulation ← Modulation Type

This function is only available if the modulation type "User Modulation" is selected.

Opens a file selection dialog box to select the file that contains the user-defined modulation (\*.vam file).

For details on user-defined modulation files see [chapter 4.3.11, "User-defined Modulation"](#), on page 83.

SCPI command:

SENS:DDEM:FORM UQAM (see [SENSe:] DDEMod: FORMat on page 270)

[SENSe:] DDEMod: USER: NAME on page 275

### Modulation Order

Depending on the [Modulation Type](#), various orders of modulation are available:

Type	Available orders		
PSK	BPSK	3Pi/4-QPSK	Pi/8-D8PSK
	QPSK	8PSK	DQPSK
	Offset QPSK	3Pi/8-8PSK	Pi/4-DQPSK
	Pi/4-QPSK	D8PSK	
MSK	MSK	DMSK	
QAM	16QAM	-Pi/4-32QAM	256QAM
	Pi/4-16QAM	64QAM	512QAM
	32QAM	128QAM	1024QAM
FSK	2FSK	4FSK	8FSK



Type	Available orders		
ASK	2ASK	4ASK	
APSK	16APSK	32APSK	

SCPI command:

**PSK:**

[\[SENSe:\] DDEMod:PSK:FORMat](#) on page 272

[\[SENSe:\] DDEMod:PSK:NSTate](#) on page 272

[\[SENSe:\] DDEMod:QPSK:FORMat](#) on page 273

**MSK:** [\[SENSe:\] DDEMod:MSK:FORMat](#) on page 271

**QAM:**

[\[SENSe:\] DDEMod:QAM:FORMat](#) on page 272

[\[SENSe:\] DDEMod:QAM:NSTate](#) on page 273

**FSK:** [\[SENSe:\] DDEMod:FSK:NSTate](#) on page 270

**ASK:** [\[SENSe:\] DDEMod:ASK:NSTate](#) on page 269

**APSK:** [\[SENSe:\] DDEMod:APSK:NSTate](#) on page 269

**FSK Ref Deviation (FSK only)**

The FSK Reference Deviation sets the deviation to the reference frequency.

In case of 2FSK, it indicates the distance from the reference frequency to the positive / negative deviation frequency and in case of 4FSK, the distance to the outer positive/ negative deviation frequency.

To set the deviation as a multiple of the symbol rate ( $x \cdot SR$ ), select "Relative" mode. To set the deviation as an absolute value in Hz, select "Absolute" mode.

Note that this parameter is available only for FSK modulated signals.

SCPI command:

[CALCulate<n>:FSK:DEVIation:REFerence\[:VALue\]](#) on page 268

[CALCulate<n>:FSK:DEVIation:REFerence:RELative](#) on page 268

**Modulation Mapping**

The available mapping types depend on the [Modulation Type](#) and [Modulation Order](#).

For more information on the modulation mapping, refer to [chapter 4.3, "Symbol Mapping"](#), on page 63

SCPI command:

[\[SENSe:\] DDEMod:MAPPING\[:VALue\]](#) on page 271

[\[SENSe:\] DDEMod:MAPPING:CATalog?](#) on page 271

**Symbol Rate**

The symbol rate also determines the I/Q bandwidth of the data recording and demodulation. You can change the default rate by entering a value in Hz.

The minimum symbol rate is 25 Hz. The maximum symbol rate depends on the defined [Sample Rate](#) (see [chapter 4.2, "Sample Rate, Symbol Rate and I/Q Bandwidth"](#), on page 57).

SCPI command:

[\[SENSe:\] DDEMod:SRATe](#) on page 274

### Transmit Filter Type

Defines the type of transmit filter

An overview of available transmit filters is provided in [chapter A.2.1, "Transmit Filters"](#), on page 404.

For more information on transmit filters see [chapter 4.1.3, "Modulation and Demodulation Filters"](#), on page 52.

SCPI command:

[\[SENSe:\] DDEMod:TFILter:NAME](#) on page 275

To define the name of the transmit filter to be used.

[\[SENSe:\] DDEMod:TFILter\[:STATe\]](#) on page 275

To switch off the transmit filter.

[\[SENSe:\] DDEMod:TFILter:USER](#) on page 275

To select a user-defined filter.

### Load User Filter ← Transmit Filter Type

Opens a file-selection dialog box to select the user-defined transmit filter to be used.

**Note:** If a user-defined transmit filter is selected and the measurement filter is defined automatically (see ["Using the Transmit Filter as a Measurement Filter \(Auto\)"](#) on page 180), a Low-ISI measurement filter according to the selected user filter is calculated and used.

For details see [chapter 4.1.5, "Customized Filters"](#), on page 55.

For detailed instructions on working with user-defined filters see [chapter 7.2.1, "How to Select User-Defined Filters"](#), on page 204.

SCPI command:

[\[SENSe:\] DDEMod:TFILter:USER](#) on page 275

[\[SENSe:\] DDEMod:TFILter:NAME](#) on page 275

### Alpha/BT

Defines the roll-off factor (Alpha) or the filter bandwidth (BT).

The roll-off factor and filter bandwidth for transmit filter is available for RC, RRC, Gauss and GMSK filter.

SCPI command:

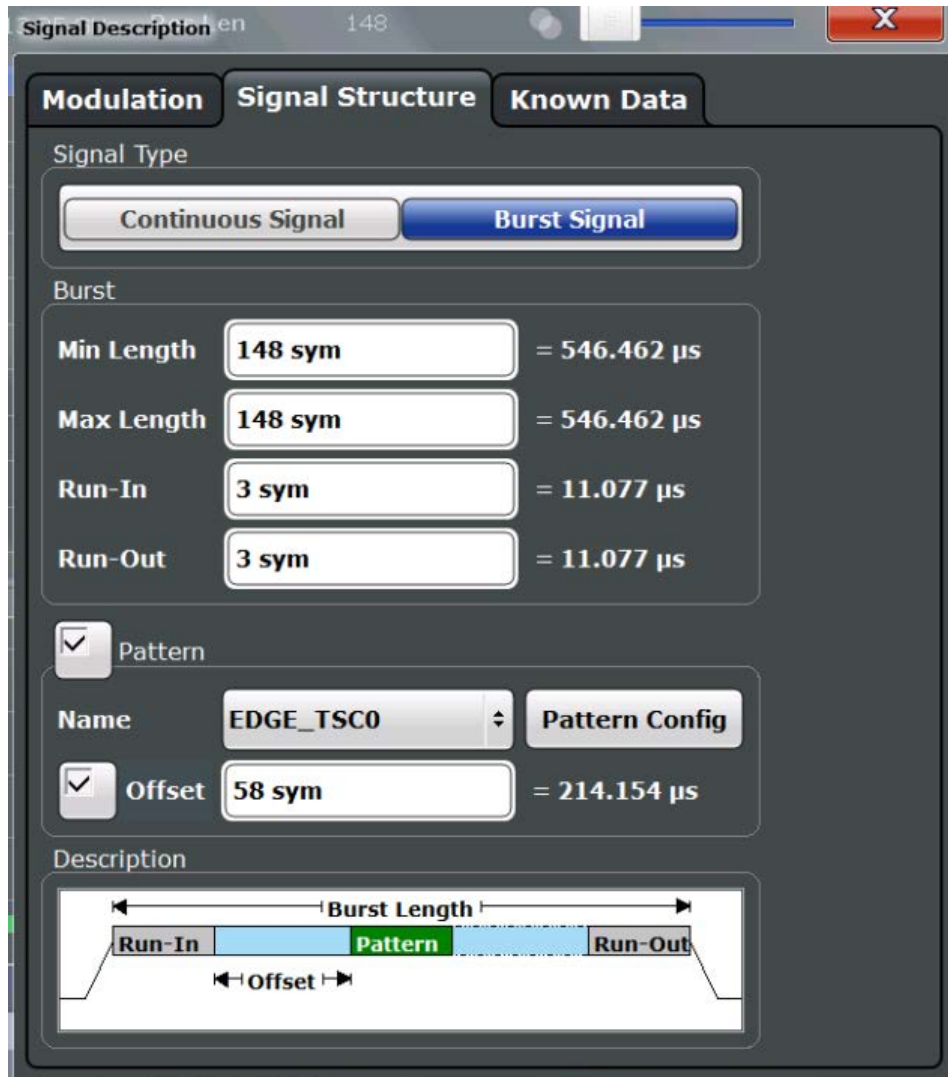
[\[SENSe:\] DDEMod:TFILter:ALPHa](#) on page 274

## 5.4.2 Signal Structure

The "Signal Structure" settings describe the expected input signal and determine which settings are available for configuration. You can define a pattern to which the instrument can be synchronized, thus adapting the result range.

A visualization of the currently defined signal structure is displayed at the bottom of the dialog box.

The "Signal Structure" settings are displayed when you select the "Signal Description" button in the "Overview" or the "Signal Description" softkey in the main VSA menu and then switch to the "Signal Structure" tab.



Signal Type.....	132
Burst Settings.....	132
L Min Length / Max Length.....	132
L Run-In.....	132
L Run-Out.....	132
Pattern Settings.....	132
L Name.....	132
L Pattern Configuration.....	132
L Offset.....	133

**Signal Type**

Determines whether the signal is continuous or contains bursts.

SCPI command:

[\[SENSe:\] DDEMod:SIGNal\[:VALue\]](#) on page 278

**Burst Settings**

For bursts, further settings are available.

**Min Length / Max Length ← Burst Settings**

Shortest and longest expected burst length in symbols ( $\leq 15000$ ). The symbols are converted to seconds for reference.

SCPI command:

[\[SENSe:\] DDEMod:SEARCh:BURSt:LENGth:MAXimum](#) on page 276

[\[SENSe:\] DDEMod:SEARCh:BURSt:LENGth\[:MINimum\]](#) on page 276

**Run-In ← Burst Settings**

The number of symbols before the signal is assumed to have valid modulated symbols.

The symbols are converted to seconds for reference.

SCPI command:

[\[SENSe:\] DDEMod:SEARCh:BURSt:SKIP:RISing](#) on page 277

**Run-Out ← Burst Settings**

The number of symbols before the falling edge that do not necessarily need to have a valid modulation.

The symbols are converted to seconds for reference.

SCPI command:

[\[SENSe:\] DDEMod:SEARCh:BURSt:SKIP:FALLing](#) on page 277

**Pattern Settings**

If the signal is expected to have a specific pattern, enable the "Pattern" option to define the pattern settings.

**Note:** The pattern search itself must be enabled separately in the "Pattern Search Settings", see ["Enabling Pattern Searches"](#) on page 163. By default, the pattern search is active if the signal description contains a pattern.

**Name ← Pattern Settings**

Specifies the pattern name from the list of defined patterns. You can also configure new patterns, see [chapter 5.7.3, "Pattern Configuration"](#), on page 164.

SCPI command:

[\[SENSe:\] DDEMod:SIGNal:PATTern](#) on page 278

**Pattern Configuration ← Pattern Settings**

Displays the "Pattern Configuration" dialog box (see [chapter 5.7.3, "Pattern Configuration"](#), on page 164).

**Offset ← Pattern Settings**

The offset of the pattern is defined with respect to the start of the useful part of the burst (see "Useful length" on page 114). If the position of the pattern within the burst is known, it is recommended that you define the offset. That will accelerate the pattern search and enhance the accuracy of the burst search.

SCPI command:

[SENSe:] DDEMod: STANdard: SYNC: OFFSet: STATe on page 278

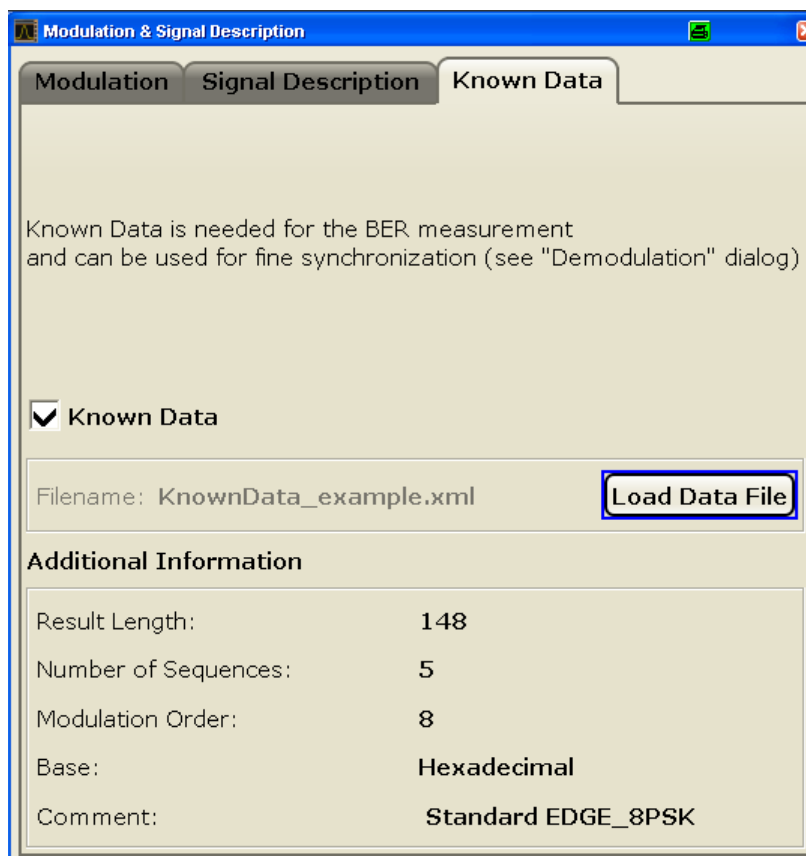
[SENSe:] DDEMod: STANdard: SYNC: OFFSet [:VALue] on page 278

**5.4.3 Known Data**

The "Known Data" settings allow you to load a file that describes the possible data sequences in the input signal (see chapter 7.2.3, "How to Manage Known Data Files", on page 208).

Additional information provided by the loaded file is displayed at the bottom of the dialog box. This information is not editable directly.

The "Known Data" settings are displayed when you select the "Signal Description" button in the "Overview" or the "Signal Description" softkey in the main VSA menu and then switch to the "Known Data" tab.



Known Data.....134  
 Load Data File.....134

**Known Data**

Activates or deactivates the use of the loaded data file (if available). When deactivated, the additional information from the previously loaded data file is removed. Any references to the known data in the "Demodulation" dialog box are replaced by the default parameter values (see [chapter 5.9.2, "Advanced Demodulation \(Synchronization\)"](#), on page 175).

**Note:** When a standard is loaded, the use of a Known Data file is automatically deactivated.

SCPI command:

[SENSe:] DDEMod:KDATA:STATE on page 318

**Load Data File**

If [Known Data](#) is activated, this function displays a file selection dialog box to select the xml file that contains the known data. Once a file has been selected, any additional information provided by the file is displayed at the bottom of the dialog box.

SCPI command:

[SENSe:] DDEMod:KDATA[:NAME] on page 318

## 5.5 Input and Frontend Settings

The R&S FSW can evaluate signals from different input sources and provide various types of output (such as noise or trigger signals).

The frequency and amplitude settings represent the "frontend" of the measurement setup.

- [Input Settings](#)..... 134
- [Frontend Settings](#)..... 138
- [Frequency Settings](#)..... 141
- [Amplitude and Vertical Axis Configuration](#)..... 143

### 5.5.1 Input Settings

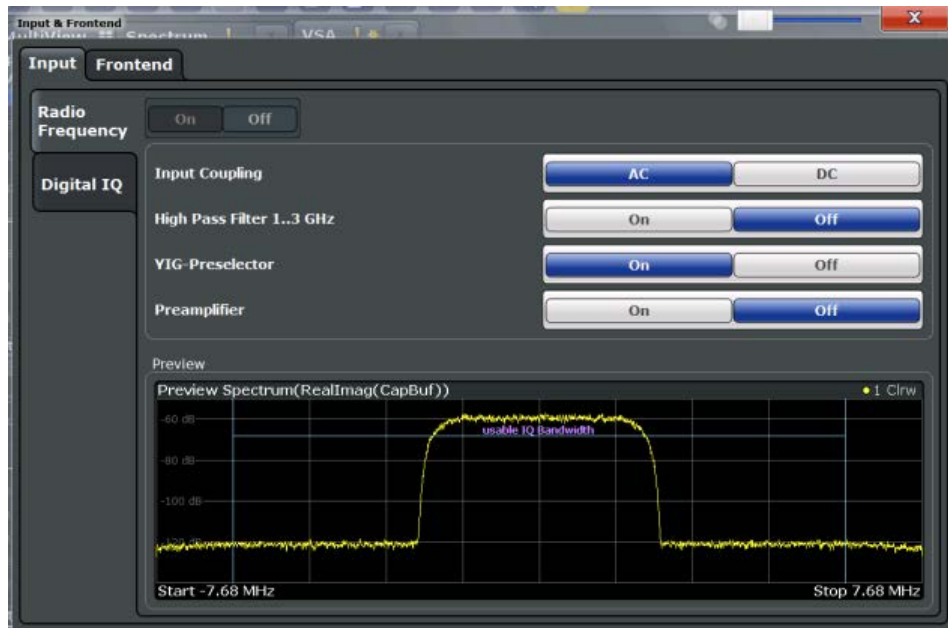
Input settings can be configured via the INPUT/OUTPUT key, in the "Input" dialog box.

Some settings are also available in the "Amplitude" tab of the "Amplitude" dialog box.

- [Radio Frequency Input](#)..... 134
- [Digital I/Q Input Settings](#)..... 136

#### 5.5.1.1 Radio Frequency Input

The default input source for the R&S FSW is the radio frequency. If no additional options are installed, this is the only available input source.



Radio Frequency State..... 135  
 Input Coupling..... 135  
 High-Pass Filter 1...3 GHz..... 135  
 YIG-Preselector..... 136  
 Preamplifier (option B24)..... 136

**Radio Frequency State**

Activates input from the RF INPUT connector.

SCPI command:

[INPut:SElect](#) on page 280

**Input Coupling**

The RF input of the R&S FSW can be coupled by alternating current (AC) or direct current (DC).

This function is not available for input from the Digital Baseband Interface (R&S FSW-B17).

AC coupling blocks any DC voltage from the input signal. This is the default setting to prevent damage to the instrument. Very low frequencies in the input signal may be distorted.

However, some specifications require DC coupling. In this case, you must protect the instrument from damaging DC input voltages manually. For details, refer to the data sheet.

SCPI command:

[INPut:COUPling](#) on page 279

**High-Pass Filter 1...3 GHz**

Activates an additional internal high-pass filter for RF input signals from 1 GHz to 3 GHz. This filter is used to remove the harmonics of the R&S FSW in order to measure the harmonics for a DUT, for example.

This function requires option R&S FSW-B13.

(Note: for RF input signals outside the specified range, the high-pass filter has no effect. For signals with a frequency of approximately 4 GHz upwards, the harmonics are suppressed sufficiently by the YIG filter.)

SCPI command:

[INPut:FILTer:HPASs\[:STATe\]](#) on page 280

#### YIG-Preselector

Activates or deactivates the YIG-preselector.

An internal YIG-preselector at the input of the R&S FSW ensures that image frequencies are rejected. However, this is only possible for a restricted bandwidth. In order to use the maximum bandwidth for signal analysis you can deactivate the YIG-preselector at the input of the R&S FSW, which may lead to image-frequency display.

Note that the YIG-preselector is active only on frequencies greater than 8 GHz. Therefore, switching the YIG-preselector on or off has no effect if the frequency is below that value.

[INPut:FILTer:YIG\[:STATe\]](#) on page 280

#### Preamplifier (option B24)

If option R&S FSW-B24 is installed, a preamplifier can be activated for the RF input signal.

This function is not available for input from the Digital Baseband Interface (R&S FSW-B17).

For R&S FSW 26 models, the input signal is amplified by 30 dB if the preamplifier is activated.

For R&S FSW 8 or 13 models, the following settings are available:

"Off"	Deactivates the preamplifier.
"15 dB"	The RF input signal is amplified by about 15 dB.
"30 dB"	The RF input signal is amplified by about 30 dB.

SCPI command:

[INPut:GAIN:STATe](#) on page 288

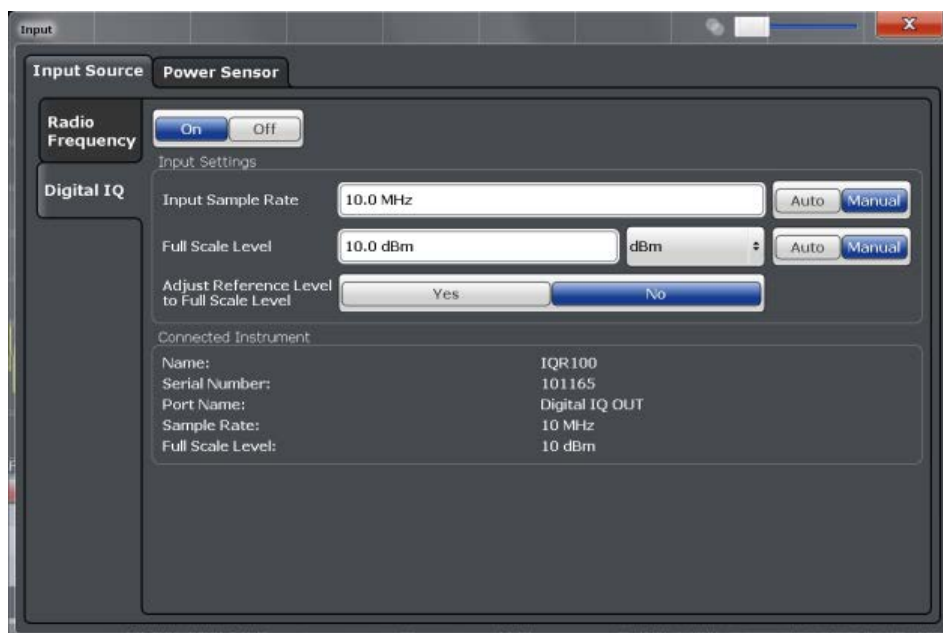
[INPut:GAIN\[:VALue\]](#) on page 287

#### 5.5.1.2 Digital I/Q Input Settings

The following settings and functions are available to provide input via the Digital Baseband Interface (R&S FSW-B17) in the applications that support it.

They can be configured via the INPUT/OUTPUT key, in the "Input" dialog box.





Digital I/Q Input State.....137  
 Input Sample Rate.....137  
 Full Scale Level.....137  
 Adjust Reference Level to Full Scale Level.....138  
 Connected Instrument.....138  
 DigIConf.....138

**Digital I/Q Input State**

Enables or disable the use of the "Digital IQ" input source for measurements. "Digital IQ" is only available if the Digital Baseband Interface (R&S FSW-B17) is installed.

SCPI command:

[INPut:SElect](#) on page 280

**Input Sample Rate**

Defines the sample rate of the digital I/Q signal source. This sample rate must correspond with the sample rate provided by the connected device, e.g. a generator.

If "Auto" is selected, the sample rate is adjusted automatically by the connected device.

The allowed range is from 100 Hz to 10 GHz.

SCPI command:

[INPut:DIQ:SRATe](#) on page 284

[INPut:DIQ:SRATe:AUTO](#) on page 284

**Full Scale Level**

The "Full Scale Level" defines the level and unit that should correspond to an I/Q sample with the magnitude "1".

If "Auto" is selected, the level is automatically set to the value provided by the connected device.

SCPI command:

[INPut:DIQ:RANGe\[:UPPer\]](#) on page 283

[INPut:DIQ:RANGe\[:UPPer\]:UNIT](#) on page 284

[INPut:DIQ:RANGe:AUTO](#) on page 283

#### Adjust Reference Level to Full Scale Level

If enabled, the reference level is adjusted to the full scale level automatically if any change occurs.

SCPI command:

[INPut:DIQ:RANGe:COUPling](#) on page 283

#### Connected Instrument

Displays the status of the Digital Baseband Interface connection.

If an instrument is connected, the following information is displayed:

- Name and serial number of the instrument connected to the Digital Baseband Interface
- Used port
- Sample rate of the data currently being transferred via the Digital Baseband Interface
- Level and unit that corresponds to an I/Q sample with the magnitude "1" ([Full Scale Level](#)), if provided by connected instrument

SCPI command:

[INPut:DIQ:CDEvice](#) on page 282

#### DigIConf

Starts the optional R&S DigIConf application. This softkey is available in the In-/Output menu, but only if the optional software is installed.

**Note that R&S DigIConf requires a USB connection (not LAN!) from the R&S FSW to the R&S EX-IQ-BOX in addition to the Digital Baseband Interface (R&S FSW-B17) connection. R&S DigIConf version 2.20.360.86 Build 170 or higher is required.**

To return to the R&S FSW application, press any key on the front panel. The R&S FSW application is displayed with the "Input/Output" menu, regardless of which key was pressed.

For details on the R&S DigIConf application, see the "R&S®EX-IQ-BOX Digital Interface Module R&S®DigIConf Software Operating Manual".

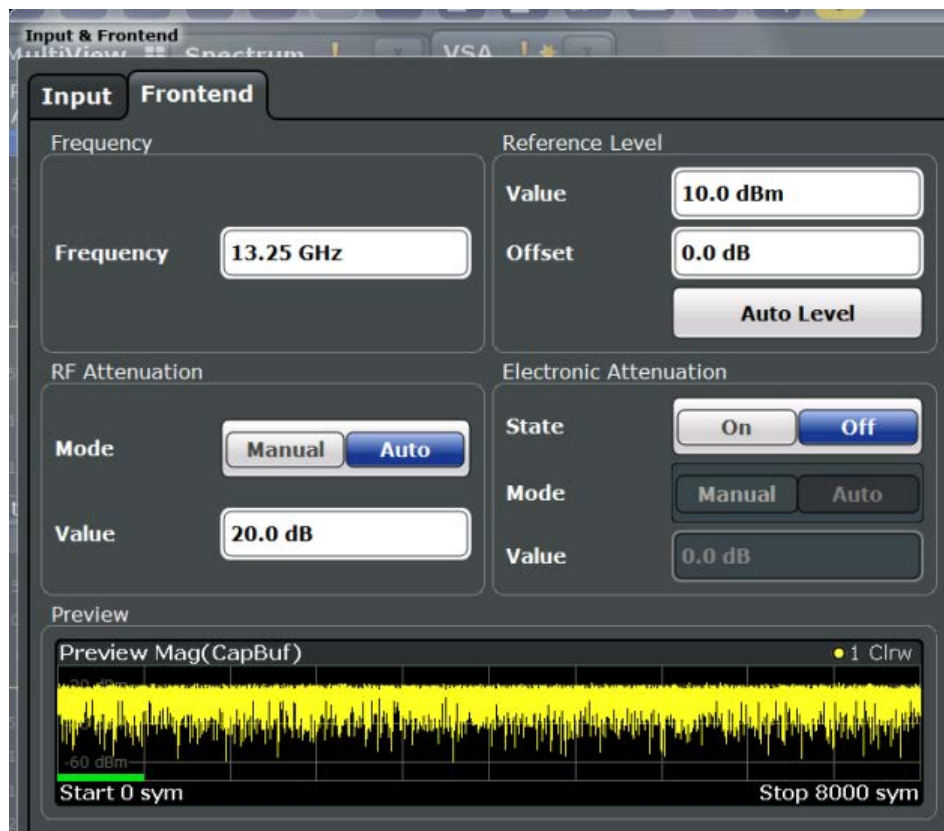
**Note:** If you close the R&S DigIConf window using the "Close" icon, the window is minimized, not closed.

If you select the "File > Exit" menu item in the R&S DigIConf window, the application is closed. Note that in this case the settings are lost and the EX-IQ-BOX functionality is no longer available until you restart the application using the "DigIConf" softkey in the R&S FSW once again.

## 5.5.2 Frontend Settings

Frontend settings affect the signal power or error levels.

To configure the Frontend settings select "Input/Frontend" from the "Overview", then switch to the "Frontend" tab.



Center.....139

Reference Level.....139

    └ Shifting the Display (Offset).....140

    └ Setting the Reference Level Automatically (Auto Level).....140

RF Attenuation.....140

    └ Attenuation Mode / Value.....140

Using Electronic Attenuation (Option B25).....141

**Center**

Defines the normal center frequency of the signal. The allowed range of values for the center frequency depends on the frequency span.

$$\text{span} > 0: \text{span}_{\text{min}}/2 \leq f_{\text{center}} \leq f_{\text{max}} - \text{span}_{\text{min}}/2$$

$f_{\text{max}}$  and  $\text{span}_{\text{min}}$  are specified in the data sheet.

SCPI command:

[SENSe:] FREQuency: CENTer on page 285

**Reference Level**

Defines the expected maximum reference level. Signal levels above this value may not be measured correctly, which is indicated by the "IFOVL" status display.

The reference level is also used to scale power diagrams; the reference level is then used as the maximum on the y-axis.

Since the R&S FSW hardware is adapted according to this value, it is recommended that you set the reference level close above the expected maximum signal level to ensure an optimum measurement (no compression, good signal-to-noise ratio).

Note that the "Reference Level" value ignores the [Shifting the Display \(Offset\)](#). It is important to know the actual power level the R&S FSW must handle.

SCPI command:

`DISPlay[:WINDow<n>]:TRACe:Y[:SCALe]:RLEVel` on page 286

#### **Shifting the Display (Offset) ← Reference Level**

Defines an arithmetic level offset. This offset is added to the measured level irrespective of the selected unit. The scaling of the y-axis is changed accordingly.

Define an offset if the signal is attenuated or amplified before it is fed into the R&S FSW so the application shows correct power results. All displayed power level results will be shifted by this value.

Note, however, that the [Reference Level](#) value ignores the "Reference Level Offset". It is important to know the actual power level the R&S FSW must handle.

To determine the required offset, consider the external attenuation or gain applied to the input signal. A positive value indicates that an attenuation took place (R&S FSW increases the displayed power values), a negative value indicates an external gain (R&S FSW decreases the displayed power values).

The setting range is  $\pm 200$  dB in 0.01 dB steps.

SCPI command:

`DISPlay[:WINDow<n>]:TRACe:Y[:SCALe]:RLEVel:OFFSet` on page 287

#### **Setting the Reference Level Automatically (Auto Level) ← Reference Level**

Automatically determines the optimal reference level for the current input data. At the same time, the internal attenuators and the preamplifier are adjusted so the signal-to-noise ratio is optimized, while signal compression, clipping and overload conditions are minimized.

In order to do so, a level measurement is performed to determine the optimal reference level.

You can change the measurement time for the level measurement if necessary (see ["Changing the Automatic Measurement Time \(Meastime Manual\)"](#) on page 183).

SCPI command:

`[SENSe:]ADJust:LEVel` on page 326

#### **RF Attenuation**

Defines the mechanical attenuation for RF input.

This function is not available for input from the R&S Digital Baseband Interface (option R&S FSW-B17).

#### **Attenuation Mode / Value ← RF Attenuation**

The RF attenuation can be set automatically as a function of the selected reference level (Auto mode). This ensures that the optimum RF attenuation is always used. It is the default setting. By default and when [Using Electronic Attenuation \(Option B25\)](#) is not available, mechanical attenuation is applied.

This function is not available for input from the **Digital Baseband Interface (R&S FSW-B17)**.

In "Manual" mode, you can set the RF attenuation in 1 dB steps (down to 0 dB, also using the rotary knob). Other entries are rounded to the next integer value. The range is specified in the data sheet. If the defined reference level cannot be set for the defined RF attenuation, the reference level is adjusted accordingly and the warning "Limit reached" is displayed.

**NOTICE!** Risk of hardware damage due to high power levels. When decreasing the attenuation manually, ensure that the power level does not exceed the maximum level allowed at the RF input, as an overload may lead to hardware damage.

SCPI command:

`INPut:ATTenuation` on page 288

`INPut:ATTenuation:AUTO` on page 289

### Using Electronic Attenuation (Option B25)

If option R&S FSW-B25 is installed, you can also activate an electronic attenuator.

In "Auto" mode, the settings are defined automatically; in "Manual" mode, you can define the mechanical and electronic attenuation separately.

This function is not available for input from the Digital Baseband Interface (R&S FSW-B17).

**Note:** Electronic attenuation is not available for stop frequencies (or center frequencies in zero span) >13.6 GHz.

In "Auto" mode, RF attenuation is provided by the electronic attenuator as much as possible to reduce the amount of mechanical switching required. Mechanical attenuation may provide a better signal-to-noise ratio, however.

When you switch off electronic attenuation, the RF attenuation is automatically set to the same mode (auto/manual) as the electronic attenuation was set to. Thus, the RF attenuation may be set to automatic mode, and the full attenuation is provided by the mechanical attenuator, if possible.

Both the electronic and the mechanical attenuation can be varied in 1 dB steps. Other entries are rounded to the next lower integer value.

If the defined reference level cannot be set for the given attenuation, the reference level is adjusted accordingly and the warning "Limit reached" is displayed in the status bar.

SCPI command:

`INPut:EATT:STATE` on page 290

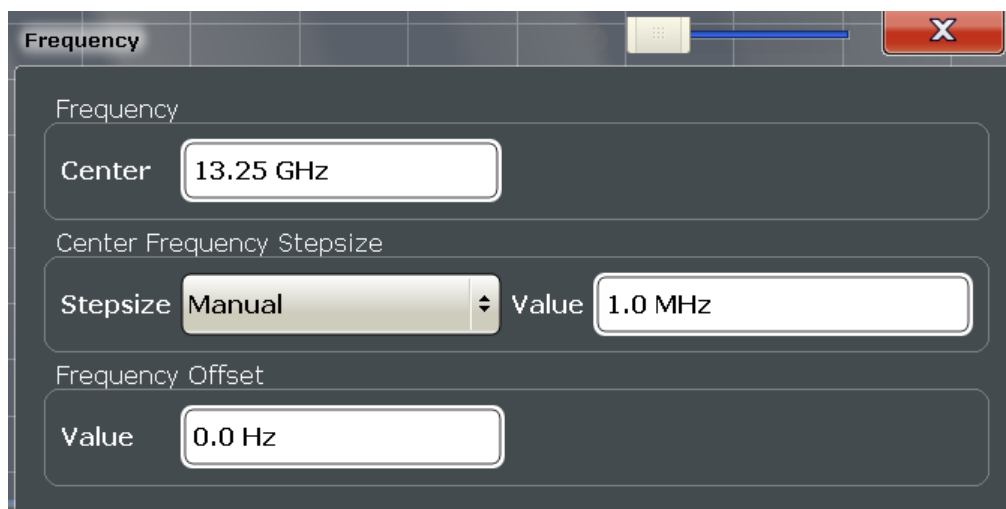
`INPut:EATT:AUTO` on page 290

`INPut:EATT` on page 289

## 5.5.3 Frequency Settings

Frequency settings for the input signal can be configured via the "Frequency" dialog box, which is displayed when you do one of the following:

- Select the **FREQ** key and then the "Frequency Config" softkey.
- Select the "Frequency" tab in the "Input Settings" dialog box



Center.....142  
 Center Frequency Stepsize.....142  
 Frequency Offset.....142

**Center**

Defines the normal center frequency of the signal. The allowed range of values for the center frequency depends on the frequency span.

$$\text{span} > 0: \text{span}_{\min}/2 \leq f_{\text{center}} \leq f_{\text{max}} - \text{span}_{\min}/2$$

$f_{\text{max}}$  and  $\text{span}_{\min}$  are specified in the data sheet.

SCPI command:

[SENSe:] FREQuency:CENTer on page 285

**Center Frequency Stepsize**

Defines the step size of the center frequency. The step size can be set to a predefined value, or it can be manually set to a user-defined value.

"Auto" The step size is set to the default value:

- using the rotary knob: 100 kHz
- using the arrow keys: 1 MHz

"Manual" Defines a user-defined step size for the center frequency. Enter the step size in the "Value" field.

SCPI command:

[SENSe:] FREQuency:CENTer:STEP:AUTO on page 285

[SENSe:] FREQuency:CENTer:STEP on page 285

**Frequency Offset**

Shifts the displayed frequency range along the x-axis by the defined offset.

This parameter has no effect on the R&S FSW hardware, or on the captured data or on data processing. It is simply a manipulation of the final results in which absolute frequency values are displayed. Thus, the x-axis of a spectrum display is shifted by a constant offset if it shows absolute frequencies, but not if it shows frequencies relative to the signal's center frequency.

A frequency offset can be used to correct the display of a signal that is slightly distorted by the measurement setup, for example.

The allowed values range from -100 GHz to 100 GHz. The default setting is 0 Hz.

SCPI command:

[SENSe:] FREQuency: OFFSet on page 286

### 5.5.4 Amplitude and Vertical Axis Configuration

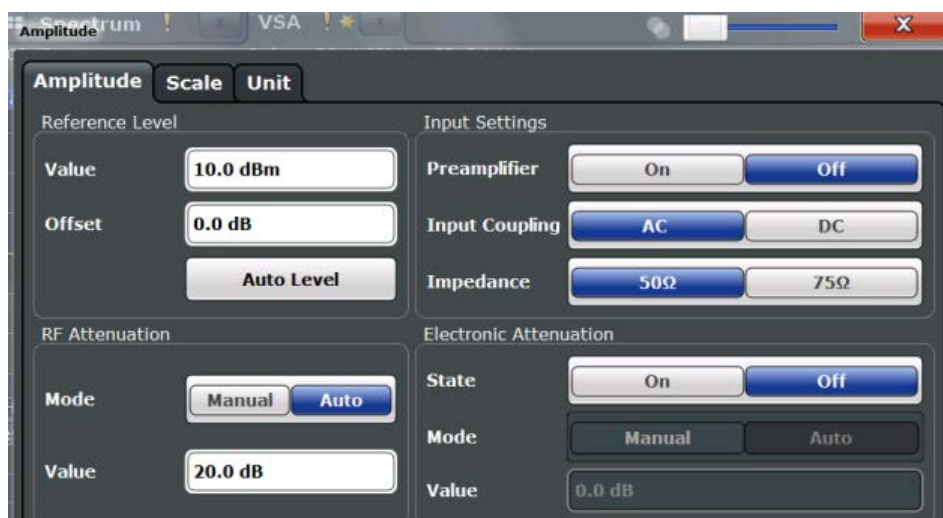
Amplitude and scaling settings allow you to configure the vertical (y-)axis display and for some result displays also the horizontal (x-)axis.

- [Amplitude Settings](#).....143
- [Scaling](#).....146
- [Units](#).....150

#### 5.5.4.1 Amplitude Settings

Amplitude settings affect the signal power or error levels.

To configure the amplitude settings select the AMPT key and then the "Amplitude Config" softkey.



Note that amplitude settings are not window-specific, as opposed to the scaling and unit settings.

- Reference Level.....144
  - └ Shifting the Display (Offset).....144
  - └ Setting the Reference Level Automatically (Auto Level).....144
- Input Settings.....145
  - └ Preamplifier (option B24).....145
  - └ Input Coupling.....145

RF Attenuation.....	145
↳ Attenuation Mode / Value.....	145
Using Electronic Attenuation (Option B25).....	146

### Reference Level

Defines the expected maximum reference level. Signal levels above this value may not be measured correctly, which is indicated by the "IFOVL" status display.

The reference level is also used to scale power diagrams; the reference level is then used as the maximum on the y-axis.

Since the R&S FSW hardware is adapted according to this value, it is recommended that you set the reference level close above the expected maximum signal level to ensure an optimum measurement (no compression, good signal-to-noise ratio).

Note that the "Reference Level" value ignores the [Shifting the Display \(Offset\)](#). It is important to know the actual power level the R&S FSW must handle.

SCPI command:

[DISPlay\[:WINDow<n>\]:TRACe:Y\[:SCALe\]:RLEVel](#) on page 286

### Shifting the Display (Offset) ← Reference Level

Defines an arithmetic level offset. This offset is added to the measured level irrespective of the selected unit. The scaling of the y-axis is changed accordingly.

Define an offset if the signal is attenuated or amplified before it is fed into the R&S FSW so the application shows correct power results. All displayed power level results will be shifted by this value.

Note, however, that the [Reference Level](#) value ignores the "Reference Level Offset". It is important to know the actual power level the R&S FSW must handle.

To determine the required offset, consider the external attenuation or gain applied to the input signal. A positive value indicates that an attenuation took place (R&S FSW increases the displayed power values), a negative value indicates an external gain (R&S FSW decreases the displayed power values).

The setting range is  $\pm 200$  dB in 0.01 dB steps.

SCPI command:

[DISPlay\[:WINDow<n>\]:TRACe:Y\[:SCALe\]:RLEVel:OFFSet](#) on page 287

### Setting the Reference Level Automatically (Auto Level) ← Reference Level

Automatically determines the optimal reference level for the current input data. At the same time, the internal attenuators and the preamplifier are adjusted so the signal-to-noise ratio is optimized, while signal compression, clipping and overload conditions are minimized.

In order to do so, a level measurement is performed to determine the optimal reference level.

You can change the measurement time for the level measurement if necessary (see ["Changing the Automatic Measurement Time \(Meastime Manual\)"](#) on page 183).

SCPI command:

[\[SENSe:\]ADJust:LEVel](#) on page 326



### Input Settings

Some input settings affect the measured amplitude of the signal, as well.

For information on other input settings see [chapter 5.5.1, "Input Settings"](#), on page 134.

### Preamplifier (option B24) ← Input Settings

If option R&S FSW-B24 is installed, a preamplifier can be activated for the RF input signal.

This function is not available for input from the Digital Baseband Interface (R&S FSW-B17).

For R&S FSW 26 models, the input signal is amplified by 30 dB if the preamplifier is activated.

For R&S FSW 8 or 13 models, the following settings are available:

"Off"	Deactivates the preamplifier.
"15 dB"	The RF input signal is amplified by about 15 dB.
"30 dB"	The RF input signal is amplified by about 30 dB.

SCPI command:

[INPut:GAIN:STATE](#) on page 288

[INPut:GAIN\[:VALue\]](#) on page 287

### Input Coupling ← Input Settings

The RF input of the R&S FSW can be coupled by alternating current (AC) or direct current (DC).

This function is not available for input from the Digital Baseband Interface (R&S FSW-B17).

AC coupling blocks any DC voltage from the input signal. This is the default setting to prevent damage to the instrument. Very low frequencies in the input signal may be distorted.

However, some specifications require DC coupling. In this case, you must protect the instrument from damaging DC input voltages manually. For details, refer to the data sheet.

SCPI command:

[INPut:COUPling](#) on page 279

### RF Attenuation

Defines the mechanical attenuation for RF input.

This function is not available for input from the R&S Digital Baseband Interface (option R&S FSW-B17).

### Attenuation Mode / Value ← RF Attenuation

The RF attenuation can be set automatically as a function of the selected reference level (Auto mode). This ensures that the optimum RF attenuation is always used. It is the default setting. By default and when [Using Electronic Attenuation \(Option B25\)](#) is not available, mechanical attenuation is applied.

This function is not available for input from the **Digital Baseband Interface (R&S FSW-B17)**.

In "Manual" mode, you can set the RF attenuation in 1 dB steps (down to 0 dB, also using the rotary knob). Other entries are rounded to the next integer value. The range is specified in the data sheet. If the defined reference level cannot be set for the defined RF attenuation, the reference level is adjusted accordingly and the warning "Limit reached" is displayed.

**NOTICE!** Risk of hardware damage due to high power levels. When decreasing the attenuation manually, ensure that the power level does not exceed the maximum level allowed at the RF input, as an overload may lead to hardware damage.

SCPI command:

[INPut:ATTenuation](#) on page 288

[INPut:ATTenuation:AUTO](#) on page 289

### Using Electronic Attenuation (Option B25)

If option R&S FSW-B25 is installed, you can also activate an electronic attenuator.

In "Auto" mode, the settings are defined automatically; in "Manual" mode, you can define the mechanical and electronic attenuation separately.

This function is not available for input from the Digital Baseband Interface (R&S FSW-B17).

**Note:** Electronic attenuation is not available for stop frequencies (or center frequencies in zero span) >13.6 GHz.

In "Auto" mode, RF attenuation is provided by the electronic attenuator as much as possible to reduce the amount of mechanical switching required. Mechanical attenuation may provide a better signal-to-noise ratio, however.

When you switch off electronic attenuation, the RF attenuation is automatically set to the same mode (auto/manual) as the electronic attenuation was set to. Thus, the RF attenuation may be set to automatic mode, and the full attenuation is provided by the mechanical attenuator, if possible.

Both the electronic and the mechanical attenuation can be varied in 1 dB steps. Other entries are rounded to the next lower integer value.

If the defined reference level cannot be set for the given attenuation, the reference level is adjusted accordingly and the warning "Limit reached" is displayed in the status bar.

SCPI command:

[INPut:EATT:STATe](#) on page 290

[INPut:EATT:AUTO](#) on page 290

[INPut:EATT](#) on page 289

#### 5.5.4.2 Scaling

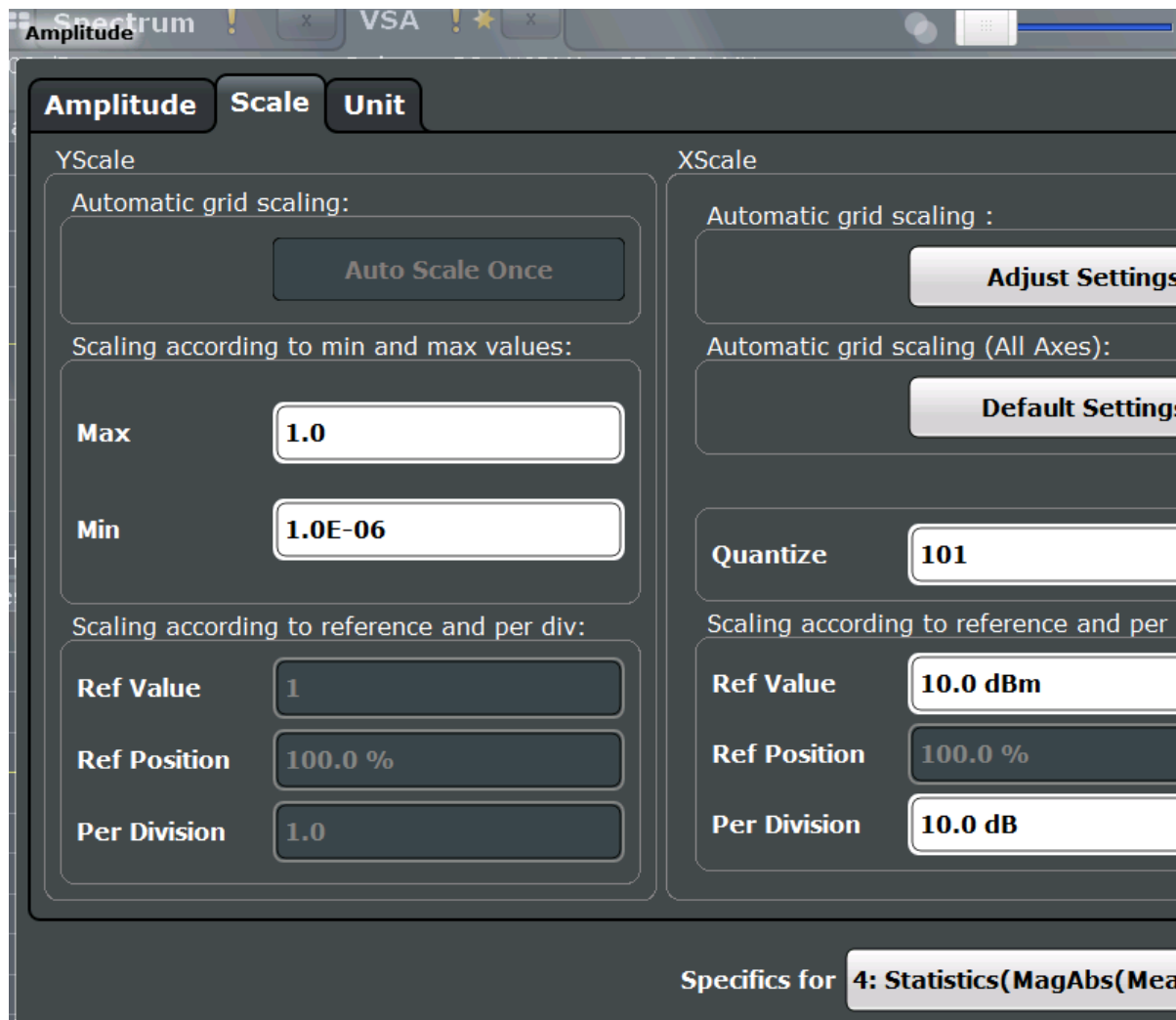
Depending on the type of display (time, spectrum or statistics), various scaling functions are available to adapt the result display to the current data.



Note that scaling settings are window-specific, as opposed to the amplitude settings.

---

The scaling settings are displayed when you select the AMPT key and then the "Scale Config" softkey.



For details on the different methods to configure the scaling see [chapter 7.3.1, "How to Change the Display Scaling"](#), on page 213.

A visualization of the diagram scaling with the current settings is displayed at the right side of the dialog box.

- [Auto Scale Once/Auto Scale Window](#)..... 148
- [Defining Min and Max Values](#)..... 148
- [Configuring a Reference Point and Divisions](#)..... 148
  - [L Y-Axis Reference Value](#)..... 148
  - [L Y-Axis Reference Position](#)..... 148
  - [L Range per Division](#)..... 148
- [X-Axis Scaling](#)..... 149
  - [L Adjust Settings](#)..... 149
  - [L Default Settings](#)..... 149
  - [L Quantize](#)..... 149

└ X-Axis Reference Value.....	149
└ X-Axis Reference Position.....	149
└ Range per Division.....	149

### Auto Scale Once/Auto Scale Window

If enabled, both the x-axis and y-axis are automatically adapted to the current measurement results (only once, not dynamically) in the selected window.

To adapt the range of all screens together, use the [Auto Scale All](#) function.

SCPI command:

`DISPlay[:WINDow<n>]:TRACe:Y[:SCALe]:AUTO ONCE` on page 324

### Defining Min and Max Values

Indicates the current range borders according to the current settings (for information only).

**For statistical evaluations only:** defines the displayed range using minimum and maximum values.

Values in the range  $1e^{-9} < value < 0.1$  are allowed. The y-axis unit is defined via the "[Y-Axis Unit](#)" on page 151 setting. The distance between max and min value must be at least one decade.

SCPI command:

`CALCulate<n>:STATistics:SCALe:Y:UPPer` on page 292

`CALCulate<n>:STATistics:SCALe:Y:LOWer` on page 292

### Configuring a Reference Point and Divisions

Defines the displayed range using a reference point and the size of the divisions.

#### Y-Axis Reference Value ← Configuring a Reference Point and Divisions

Defines a reference value on the y-axis in the current unit. The y-axis is adapted so that the reference value is displayed at the "[Y-Axis Reference Position](#)" on page 148.

SCPI command:

`DISPlay[:WINDow<n>]:TRACe:Y[:SCALe]:RVALue` on page 294

#### Y-Axis Reference Position ← Configuring a Reference Point and Divisions

Defines the position of the [Y-Axis Reference Value](#) on the y-axis. The position is defined as a percentage value, where 0 % refers to the bottom edge, 100 % refers to the top edge of the screen. The y-axis is adapted so that the reference value is displayed at the reference position.

SCPI command:

`DISPlay[:WINDow<n>]:TRACe:Y[:SCALe]:RPOSition` on page 294

#### Range per Division ← Configuring a Reference Point and Divisions

Defines the value range to be displayed per division. Since the display consists of 10 divisions by default, the displayed range is:

$Range = 10 * <Range\ per\ Division>$

**Note:** If fewer divisions are displayed (e.g. because the window is reduced in height), the range per division is increased in order to display the same result range in the smaller window. In this case, the per division value does not correspond to the actual display.

SCPI command:

`DISPlay[:WINDow<n>]:TRACe:Y[:SCALe]:PDIVision` on page 294

### X-Axis Scaling

For statistics, a histogram is displayed. For these diagrams, the x-axis can be configured, as well.

#### Adjust Settings ← X-Axis Scaling

Adjusts the x-axis scaling to the occurring statistical values.

SCPI command:

`CALCulate<n>:STATistics:SCALE:AUTO ONCE` on page 291

#### Default Settings ← X-Axis Scaling

Resets the x- and y-axis scalings to their preset values for the current measurement window.

SCPI command:

`CALCulate<n>:STATistics:PRESet` on page 291

#### Quantize ← X-Axis Scaling

Defines the number of bars to be displayed in the graph, i.e. the granularity of classifications.

SCPI command:

`CALCulate<n>:STATistics:SCALE:X:BCOunt` on page 291

#### X-Axis Reference Value ← X-Axis Scaling

Defines a reference value on the x-axis in the current unit.

SCPI command:

`DISPlay[:WINDow<n>]:TRACe<t>:X[:SCALe]:RVALue` on page 293

#### X-Axis Reference Position ← X-Axis Scaling

Defines the position of the [X-Axis Reference Value](#) on the x-axis. The position is defined as a percentage value, where 0 % refers to the beginning (left side), 100 % refers to the end (right side) of the diagram. The x-axis is adapted so that the reference value is displayed at the reference position.

SCPI command:

`DISPlay[:WINDow<n>]:TRACe<t>:X[:SCALe]:RPOSition` on page 293

#### Range per Division ← X-Axis Scaling

Defines the value range to be displayed per division on the x-axis. Since the display consists of 10 divisions by default, the displayed range is:

$Range = 10 * <Range\ per\ Division>$

**Note:** If fewer divisions are displayed (e.g. because the window is reduced in width), the range per division is increased in order to display the same result range in the smaller window. In this case, the per division value does not correspond to the actual display.

SCPI command:

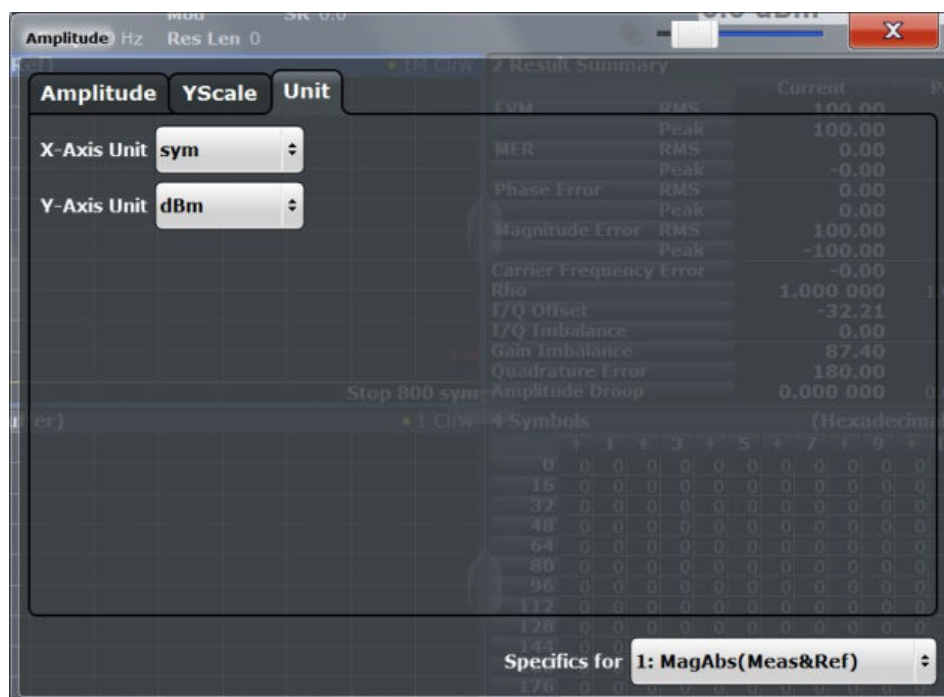
`DISPlay[:WINDow<n>]:TRACe<t>:X[:SCALe]:PDIVision` on page 293

### 5.5.4.3 Units

You can configure the units for both axes of the diagrams.

The unit settings are displayed when you do one of the following:

- Select "Input/Frontend" from the "Overview" and then switch to the "Unit" tab.
- Select the AMPT key and then the "Unit Config" softkey.



Note that unit settings are window-specific, as opposed to the amplitude settings.

X-Axis Unit..... 150  
 Y-Axis Unit..... 151

#### X-Axis Unit

Defines the unit of the x-axis in the current result diagram.

SCPI command:

`CALCulate<n>:X:UNIT:TIME` on page 292

**Y-Axis Unit**

Defines the unit of the y-axis in the current result diagram.

SCPI command:

[DISPlay\[:WINDow<n>\]:TRACe:Y:SPACing](#) on page 294

For phase diagrams: [CALCulate<n>:UNIT:ANGLE](#) on page 292

For statistics: [CALCulate<n>:STATistics:SCALE:Y:UNIT](#) on page 292

**5.6 Signal Capture**

The "Signal Capture" settings define how much, how and when data is captured from the input signal.

The "Signal Capture" settings are displayed when you select the "Signal Capture" button from the "Overview" or the "Signal Capture" softkey from the main VSA menu.

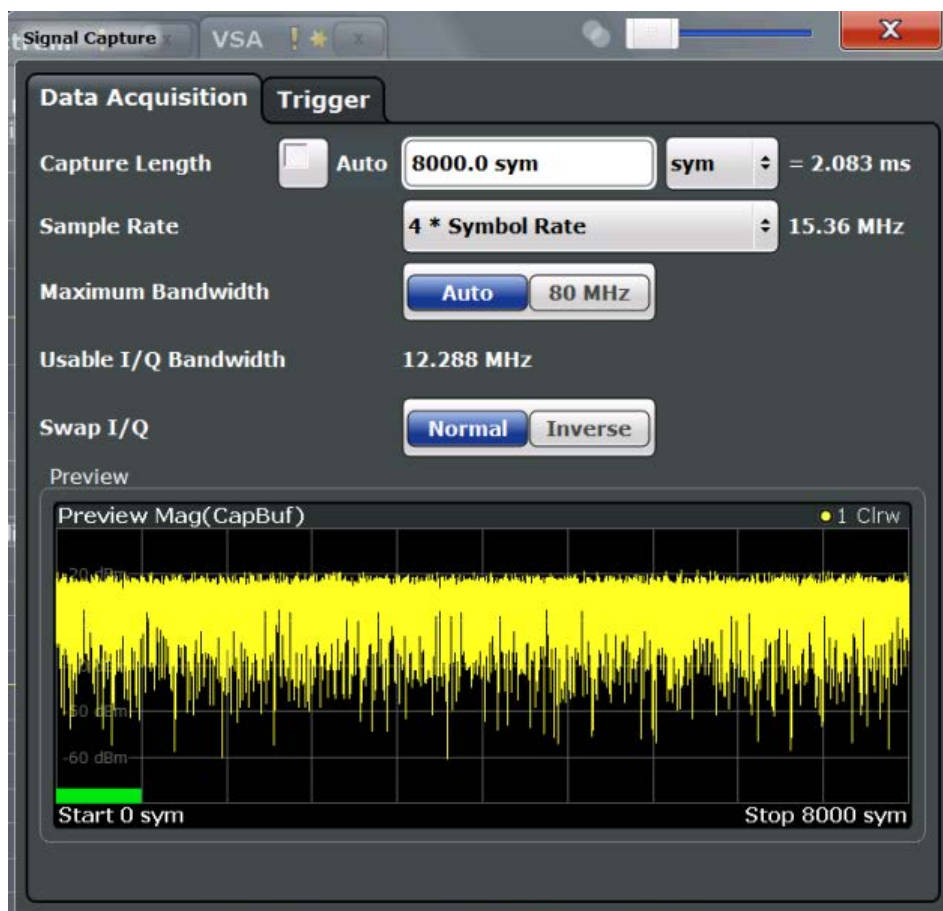
- [Data Acquisition](#).....151
- [Trigger Settings](#).....154
- [Sweep Settings](#).....158

**5.6.1 Data Acquisition**

The "Data Acquisition" settings define how much and how data is captured from the input signal.

A live preview of the signal in the capture buffer with the current settings is displayed in the preview area at the bottom of the dialog box. The preview area is not editable directly.

The "Data Acquisition" settings are displayed when you select the "Signal Capture" button from the "Overview" or the "Signal Capture" softkey from the main VSA menu.



**MSRA operating mode**

In MSRA operating mode, only the MSRA Master channel actually captures data from the input signal. The data acquisition settings for the VSA application in MSRA mode define the **application data extract** and **analysis interval**.

For details on the MSRA operating mode see the R&S FSW MSRA User Manual.

[Capture Length Settings](#).....152  
[Sample Rate](#).....153  
[Maximum Bandwidth](#).....153  
[Usable I/Q Bandwidth](#).....153  
[Swap I/Q](#).....153

**Capture Length Settings**

The capture length defines how many symbols are captured during each measurement. Enable the "Auto" option to define the capture length automatically according to the burst and pattern length settings and the statistics count. Thus, a minimal capture length is used, which improves performance.



If the capture length is not defined automatically, enter the number of symbols or seconds to be captured and select the used unit. The defined number is converted to the alternative unit (seconds/symbols) for reference.

SCPI command:

[SENSe:] DDEMod:RLENgth:AUTO on page 296

[SENSe:] DDEMod:RLENgth[:VALue] on page 296

### Sample Rate

Defines the number of samples to capture per symbol. The sample rate in MHz is indicated for reference. This parameter affects the demodulation bandwidth and thus the usable I/Q bandwidth.

The maximum sample rate depends on the defined [Symbol Rate](#) (see [chapter 4.2, "Sample Rate, Symbol Rate and I/Q Bandwidth"](#), on page 57).

For details on selecting the suitable sample rate, see [chapter 4.2, "Sample Rate, Symbol Rate and I/Q Bandwidth"](#), on page 57.

SCPI command:

[SENSe:] DDEMod:PRATe on page 296

### Maximum Bandwidth

Defines the maximum bandwidth to be used by the R&S FSW for I/Q data acquisition. This setting is only available if the bandwidth extension option R&S FSW-B160 / U160 is installed. Otherwise the maximum bandwidth is determined automatically.

For details on the maximum bandwidth see [chapter 4.2.1, "Sample Rate and Maximum Usable I/Q Bandwidth for RF Input"](#), on page 58.

"80 MHz"	Restricts the analysis bandwidth to a maximum of 80 MHz. The bandwidth extension option R&S FSW-B160 / U160 is deactivated.
"Auto"	(Default) Up to an analysis bandwidth of 80 MHz (or a sample rate of 100 MHz), the maximum bandwidth is set to 80 MHz. For larger bandwidths or sample rates, the bandwidth extension option R&S FSW-B160 / U160 is activated, thus allowing for a sample rate of up to 10 GHz. Note that using the bandwidth extension may cause more spurious effects.

SCPI command:

TRACe:IQ:WBANd[:STATe] on page 297

### Usable I/Q Bandwidth

Shows the usable I/Q bandwidth which depends on the selected sample rate. For details see [chapter 4.2, "Sample Rate, Symbol Rate and I/Q Bandwidth"](#), on page 57.

This information is provided for reference only.

#### Note:

In diagrams in the frequency domain (Spectrum transformation, see ["Result Type Transformation"](#) on page 197) the usable I/Q bandwidth is indicated by vertical blue lines.

### Swap I/Q

Specifies whether the I and Q values of the signal are swapped. Swapping I and Q inverts the sideband.

"Normal" Normal sideband, I+j\*Q

"Inverse" I and Q are exchanged, inverted sideband, Q+j\*I

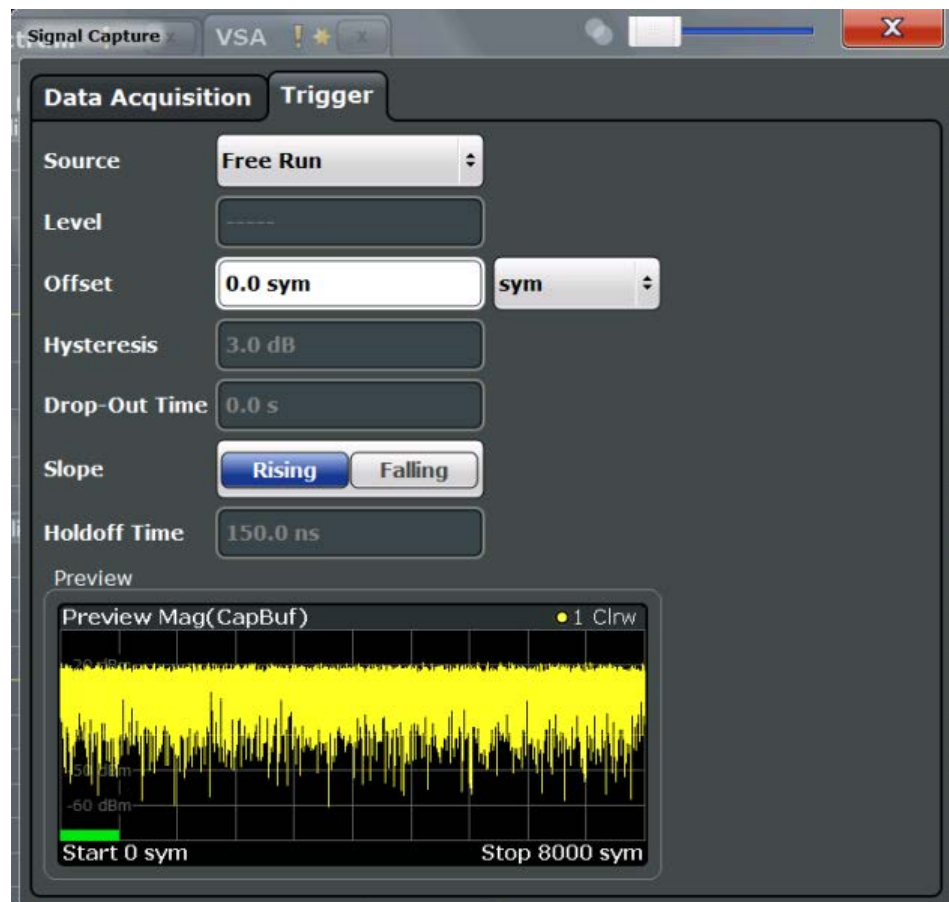
SCPI command:

[SENSe:] DDEMod: SBAND on page 297

## 5.6.2 Trigger Settings

The trigger settings define the beginning of a measurement.

Trigger settings can be configured via the TRIG key or in the "Trigger" dialog box, which is displayed when you select the "Trigger" button in the "Overview".



The TRIGGER INPUT/OUTPUT connectors on the R&S FSW can only be used for input in the VSA application, for use as external triggers. No configuration settings are available for trigger input.

For step-by-step instructions on configuring triggered measurements, see the R&S FSW User Manual.



### MSRA operating mode

In MSRA operating mode, only the MSRA Master channel actually captures data from the input signal. Thus, no trigger settings are available in the VSA application in MSRA operating mode. However, a **capture offset** can be defined with a similar effect as a trigger offset. It defines an offset from the start of the captured data (from the MSRA Master) to the start of the application data for vector signal analysis. (See [Capture Offset](#).)

For details on the MSRA operating mode see the R&S FSW MSRA User Manual.

Trigger Source.....	155
L Free Run.....	155
L External Trigger 1/2/3.....	155
L IF Power.....	156
L Baseband Power.....	156
L IQ Power.....	156
Trigger Level.....	156
Trigger Offset.....	157
Hysteresis.....	157
Drop-Out Time.....	157
Slope.....	157
Trigger Holdoff.....	158
Capture Offset.....	158

#### Trigger Source

Defines the trigger source. If a trigger source other than "Free Run" is set, "TRG" is displayed in the channel bar and the trigger source is indicated.

SCPI command:

[TRIGger \[ :SEquence \] :SOURce](#) on page 301

#### Free Run ← Trigger Source

No trigger source is considered. Data acquisition is started manually or automatically and continues until stopped explicitly.

SCPI command:

TRIG:SOUR IMM, see [TRIGger \[ :SEquence \] :SOURce](#) on page 301

#### External Trigger 1/2/3 ← Trigger Source

Data acquisition starts when the TTL signal fed into the specified input connector (on the front or rear panel) meets or exceeds the specified trigger level.

(See ["Trigger Level"](#) on page 156).

**Note:** The "External Trigger 1" softkey automatically selects the trigger signal from the TRIGGER INPUT connector on the front panel.

For details see the "Instrument Tour" chapter in the R&S FSW Getting Started manual.

"External Trigger 1"

Trigger signal from the TRIGGER INPUT connector on the front panel.

**"External Trigger 2"**

Trigger signal from the TRIGGER INPUT/OUTPUT connector on the front panel.

Note: in VSA, trigger output is not supported, thus the connector is always configured for input.

**"External Trigger 3"**

Trigger signal from the TRIGGER 3 INPUT/ OUTPUT connector on the rear panel.

Note: in VSA, trigger output is not supported, thus the connector is always configured for input.

SCPI command:

TRIG:SOUR EXT, TRIG:SOUR EXT2, TRIG:SOUR EXT3

See [TRIGger\[:SEquence\]:SOURce](#) on page 301

**IF Power ← Trigger Source**

The R&S FSW starts capturing data as soon as the trigger threshold is exceeded around the third intermediate frequency.

For frequency sweeps, the third IF represents the start frequency. The trigger bandwidth at the third IF depends on the RBW and sweep type.

For measurements on a fixed frequency (e.g. zero span or I/Q measurements), the third IF represents the center frequency.

The trigger threshold depends on the defined trigger level, as well as on the RF attenuation and preamplification. For details on available trigger levels and trigger bandwidths see the data sheet.

This trigger source is only available for RF input.

SCPI command:

TRIG:SOUR IFP, see [TRIGger\[:SEquence\]:SOURce](#) on page 301

**Baseband Power ← Trigger Source**

Defines triggering on the baseband power (for digital input via the Digital Baseband Interface R&S FSW-B17).

This trigger source is only available if "Digital IQ" is selected as the input source for the measurement (see ["Digital I/Q Input State"](#) on page 137).

SCPI command:

TRIG:SOUR BBP, see [TRIGger\[:SEquence\]:SOURce](#) on page 301

**IQ Power ← Trigger Source**

Triggers the measurement when the magnitude of the sampled I/Q data exceeds the trigger threshold.

The trigger bandwidth corresponds to the "Usable I/Q Bandwidth" setting for data acquisition (see ["Usable I/Q Bandwidth"](#) on page 153).

SCPI command:

TRIG:SOUR IQP, see [TRIGger\[:SEquence\]:SOURce](#) on page 301

**Trigger Level**

Defines the trigger level for the specified trigger source.

For details on supported trigger levels, see the data sheet.

SCPI command:

[TRIGger\[:SEquence\]:LEVel:IFPower](#) on page 300

[TRIGger\[:SEquence\]:LEVel:IQPower](#) on page 300

[TRIGger\[:SEquence\]:LEVel\[:EXternal<port>\]](#) on page 300

[TRIGger\[:SEquence\]:LEVel:BBPower](#) on page 300

### Trigger Offset

Defines the time offset between the trigger event and the start of the sweep.

The time may be entered in s or in symbols.

offset > 0:	Start of the sweep is delayed
offset < 0:	<p>Sweep starts earlier (pre-trigger)</p> <p>Only possible for zero span (e.g. I/Q Analyzer application) and gated trigger switched off</p> <p>Maximum allowed range limited by the sweep time:</p> <p><math>\text{pretrigger}_{\text{max}} = \text{sweep time}</math></p> <p>When using the Digital Baseband Interface (R&amp;S FSW-B17), the maximum range is limited by the number of pretrigger samples. (See <a href="#">table 4-2</a>)</p>

SCPI command:

[TRIGger\[:SEquence\]:HOLDoff\[:TIME\]](#) on page 299

### Hysteresis

Defines the distance in dB to the trigger level that the trigger source must exceed before a trigger event occurs. Setting a hysteresis avoids unwanted trigger events caused by noise oscillation around the trigger level.

This setting is only available for "IF Power" trigger sources. The range of the value is between 3 dB and 50 dB with a step width of 1 dB.

SCPI command:

[TRIGger\[:SEquence\]:IFPower:HYSteresis](#) on page 299

### Drop-Out Time

Defines the time the input signal must stay below the trigger level before triggering again.

SCPI command:

[TRIGger\[:SEquence\]:DTIME](#) on page 298

### Slope

For all trigger sources except time you can define whether triggering occurs when the signal rises to the trigger level or falls down to it.

SCPI command:

[TRIGger\[:SEquence\]:SLOPe](#) on page 301

**Trigger Holdoff**

Defines the minimum time (in seconds) that must pass between two trigger events. Trigger events that occur during the holdoff time are ignored.

SCPI command:

[TRIGger\[:SEquence\]:IFPower:HOLDoFF](#) on page 299

**Capture Offset**

This setting is only available for applications in **MSRA operating mode**. It has a similar effect as the trigger offset in other measurements: it defines the time offset between the capture buffer start and the start of the extracted application data. The offset must be a positive value, as the application can only analyze data that is contained in the capture buffer.

SCPI command:

[\[SENSe:\]MSRA:CAPture:OFFSet](#) on page 302

**5.6.3 Sweep Settings**

The sweep settings define how often data from the input signal is acquired and then evaluated. They are configured via the SWEEP key.

<a href="#">Continuous Sweep/RUN CONT</a> .....	158
<a href="#">Single Sweep/ RUN SINGLE</a> .....	159
<a href="#">Continue Single Sweep</a> .....	159
<a href="#">Refresh (non-MSRA mode)</a> .....	159
<a href="#">Statistic Count</a> .....	159
<a href="#">Select Result Rng</a> .....	160
<a href="#">Refresh</a> .....	160

**Continuous Sweep/RUN CONT**

After triggering, starts the measurement and repeats it continuously until stopped. This is the default setting.

While the measurement is running, the "Continuous Sweep" softkey and the RUN CONT key are highlighted. The running measurement can be aborted by selecting the highlighted softkey or key again. The results are not deleted until a new measurement is started.

**Note:** Sequencer. If the Sequencer is active, the "Continuous Sweep" softkey only controls the sweep mode for the currently selected channel; however, the sweep mode only has an effect the next time the Sequencer activates that channel, and only for a channel-defined sequence. In this case, a channel in continuous sweep mode is swept repeatedly. Furthermore, the RUN CONT key on the front panel controls the Sequencer, not individual sweeps. RUN CONT starts the Sequencer in continuous mode.

For details on the Sequencer, see the R&S FSW User Manual.

SCPI command:

[INITiate:CONTinuous](#) on page 327

**Single Sweep/ RUN SINGLE**

After triggering, starts the number of evaluations set in "Statistics Count". The measurement stops after the defined number of evaluations has been performed.

While the measurement is running, the "Single Sweep" softkey and the RUN SINGLE key are highlighted. The running measurement can be aborted by selecting the highlighted softkey or key again.

**Note:** Sequencer. If the Sequencer is active, the "Single Sweep" softkey only controls the sweep mode for the currently selected channel; however, the sweep mode only has an effect the next time the Sequencer activates that channel, and only for a channel-defined sequence. In this case, a channel in single sweep mode is swept only once by the Sequencer.

Furthermore, the RUN SINGLE key on the front panel controls the Sequencer, not individual sweeps. RUN SINGLE starts the Sequencer in single mode.

If the Sequencer is off, only the evaluation for the currently displayed measurement channel is updated.

SCPI command:

[INITiate\[:IMMEDIATE\]](#) on page 328

**Continue Single Sweep**

After triggering, repeats the number of evaluations set in "Statistics Count", without deleting the trace of the last measurement.

While the measurement is running, the "Continue Single Sweep" softkey and the RUN SINGLE key are highlighted. The running measurement can be aborted by selecting the highlighted softkey or key again.

SCPI command:

[INITiate:CONMeas](#) on page 327

**Refresh (non-MSRA mode)**

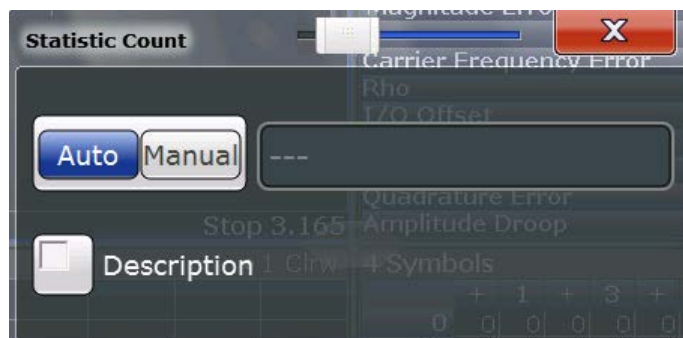
Repeats the evaluation of the data currently in the capture buffer without capturing new data. This is useful after changing settings, for example filters, patterns or evaluation ranges.

SCPI command:

[INITiate:REFMeas](#) on page 329

**Statistic Count**

Defines the number of measurements to be considered for statistical evaluations. The behavior depends on the active sweep mode.



Activate "Description" to display a visualization of the behavior of the current settings.

**Note:** If the "Statistic Count" is set to 1, trace averaging is not performed; Max Hold and Min Hold, however, remain active, unlike in the Spectrum application.

"Auto"	In single sweep mode: captures the I/Q data once and evaluates it In continuous sweep mode: captures I/Q data continuously; for each evaluation, the average is calculated over the last 10 capture sets (moving average)
"Manual"	In single sweep mode: captures I/Q data until the defined number of evaluations have been performed In continuous sweep mode: captures I/Q data continuously; if trace averaging is selected, the average is calculated over the defined number of capture sets (moving average);

SCPI command:

[SENSe:] SWEep:COUNT[:VALue] on page 303

### Select Result Rng

Selects the result range from the capture buffer that you want to evaluate.

This function is available in single sweep mode only.

By default, the application shows the results over all result ranges that have been captured in the signal capturing process and are in the R&S FSW's memory. By selecting a range number, you can evaluate a specific result range, e.g. a particular burst.

The range depends on the number of result ranges you have captured previously.

For more information refer also to [chapter 4.6, "Measurement Ranges"](#), on page 111.

SCPI command:

[SENSe:] DDEMod:SEARCh:MBURst:CALC on page 303

### Refresh

This function is only available if the Sequencer is deactivated and only for **MSRA applications**.

The data in the capture buffer is re-evaluated by the currently active application only. The results for any other applications remain unchanged.

This is useful, for example, after evaluation changes have been made or if a new sweep was performed from another application; in this case, only that application is updated automatically after data acquisition.

SCPI command:

INITiate:REFresh on page 329

## 5.7 Burst and Pattern Configuration

Information on known patterns and bursts in the captured signal improve the accuracy of the determined ideal reference signal, and calculation of the signal parameters becomes quicker.



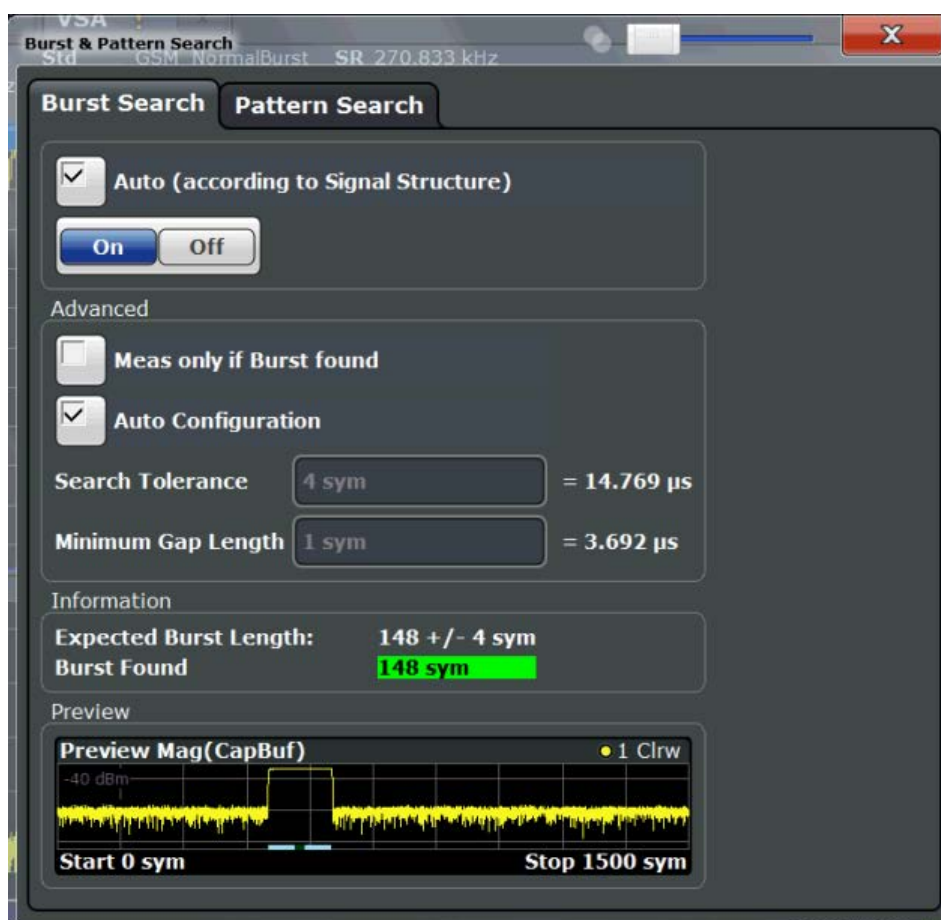
For details on burst and patterns see [chapter 4.4, "Overview of the Demodulation Process"](#), on page 84.

### 5.7.1 Burst Search

The "Burst Search" settings define when a burst is detected in the evaluated signal.

A live preview of the capture buffer with the current settings is displayed in the preview area at the bottom of the dialog box. The blue lines below the trace indicate the detected bursts. The preview area is not editable directly.

The "Burst Search" settings are displayed when you select the "Burst/Pattern" button in the "Overview" or the "Burst/Pattern Search" softkey in the main VSA menu.



Enabling Burst Searches.....	162
Measuring only if burst was found.....	162
Burst Configuration.....	162
L Search Tolerance.....	162
L Min Gap Length.....	162

### Enabling Burst Searches

Enables or disables burst searches. If "Auto" is selected, burst search is enabled only if the signal structure defines a bursted signal (in the "Signal Structure" tab of the "Modulation & Signal Description" dialog box, see ["Signal Type"](#) on page 132).

SCPI command:

[\[SENSe:\] DDEMod:SEARCh:BURSt:AUTO](#) on page 304

### Measuring only if burst was found

If enabled, measurement results are only displayed (and are only averaged) if a valid burst has been found. When measuring bursted signals that are averaged over several measurements, it is recommended that you enable this option so that erroneous measurements do not affect the result of averaging.

SCPI command:

[\[SENSe:\] DDEMod:SEARCh:BURSt:MODE](#) on page 305

### Burst Configuration

The conditions under which a burst is detected in the captured data can be configured either manually or automatically according to the defined signal structure settings (see ["Burst Settings"](#) on page 132).

SCPI command:

[\[SENSe:\] DDEMod:SEARCh:BURSt:CONFIgure:AUTO](#) on page 304

### Search Tolerance ← Burst Configuration

Defines the number of symbols that may differ from the burst length without influencing the burst detection. A search tolerance of 5, for example, with a minimum and maximum burst length of 100, will detect bursts that are 95 to 100 symbols long. (The minimum and maximum burst length is defined in the [Signal Structure](#) settings)

**Note:** Due to the fact that the VSA does not have knowledge of the ramp length, there is an uncertainty in the burst search algorithm. Thus, setting this parameter to "0" will result in a failed burst search for most signals.

SCPI command:

[\[SENSe:\] DDEMod:SEARCh:BURSt:TOLerance](#) on page 305

### Min Gap Length ← Burst Configuration

Represents the minimum distance (in symbols) between adjacent bursts. The default value is 1 symbol in order to make sure that the burst search finds bursts that are very close to each other. However, in case the capture buffer does not contain very close bursts, it is recommended that you increase the value. This makes the burst search faster and also more robust for highly distorted signals.

Note that this parameter only influences the robustness of the burst search. It should not be used to explicitly exclude certain bursts from the measurement. For example, setting the minimum gap length to 100 symbols does not ensure that the burst search does not find bursts that have a very small gap.

SCPI command:

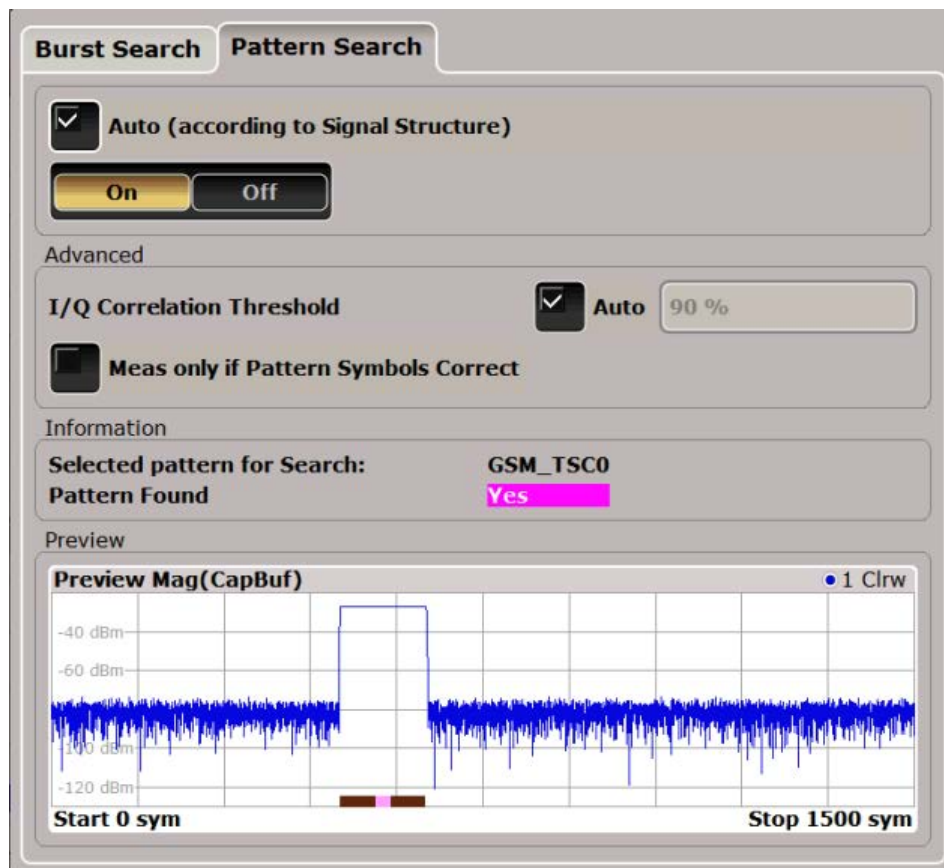
[\[SENSe:\] DDEMod:SEARCh:BURSt:GLENgth\[:MINimum\]](#) on page 305

### 5.7.2 Pattern Search

The "Pattern Search" settings define when a pattern is detected in the evaluated signal.

A live preview of the capture buffer with the current settings is displayed in the preview area at the bottom of the dialog box. The preview area is not editable directly.

The "Pattern Search" settings are displayed when you select the "Burst/Pattern" button in the "Overview" or the "Burst/Pattern Search" softkey in the main VSA menu and then switch to the "Pattern Search" tab.



Enabling Pattern Searches.....	163
I/Q Correlation Threshold.....	164
Meas only if Pattern Symbols Correct.....	164
Selected Pattern for Search.....	164
Pattern Found.....	164

#### Enabling Pattern Searches

Enables or disables pattern searches. If "Auto" is selected, pattern search is enabled only if the signal structure defines a pattern in the signal (in the "Signal Structure" tab of the "Modulation & Signal Description" dialog box, see "Pattern Settings" on page 132).

SCPI command:

[SENSe:] DDEMod: SEARCh: SYNC: STATe on page 307

[SENSe:] DDEMod: SEARCh: SYNC: AUTO on page 306

### I/Q Correlation Threshold

The I/Q correlation threshold decides whether a match is accepted or not during a pattern search (see also [chapter 4.4.2, "I/Q Pattern Search"](#), on page 88). If the parameter is set to 100%, only I/Q patterns that match totally with the input signal are found. This is only the case for infinite SNR.

If the threshold "Auto" option is enabled, the default value of 90% is used. As long as the pattern is found, there is no need to change this parameter. However, if the pattern is very short (approximately < 10 symbols) or if the signal is highly distorted, tuning this parameter helps the pattern search to succeed. To define a threshold manually, disable the "Auto" option.

SCPI command:

[\[SENSe:\]DDEMod:SEARch:SYNC:IQCThreshold](#) on page 306

[\[SENSe:\]DDEMod:SEARch:PATTern:CONFigure:AUTO](#) on page 306

### Meas only if Pattern Symbols Correct

If enabled, measurement results are only displayed (and are only averaged) if a valid pattern has been found. When measuring signals that contain a pattern and are averaged over several measurements, it is recommended that you enable this option so that erroneous measurements do not affect the result of averaging.

SCPI command:

[\[SENSe:\]DDEMod:SEARch:SYNC:MODE](#) on page 307

### Selected Pattern for Search

Indicates which of the patterns that are assigned to the current standard is selected and will be searched for.

The selected pattern is indicated for information only and cannot be edited here, only in the "Signal Structure" settings, see ["Name"](#) on page 132).

SCPI command:

[\[SENSe:\]DDEMod:SEARch:SYNC:SElect](#) on page 307

### Pattern Found

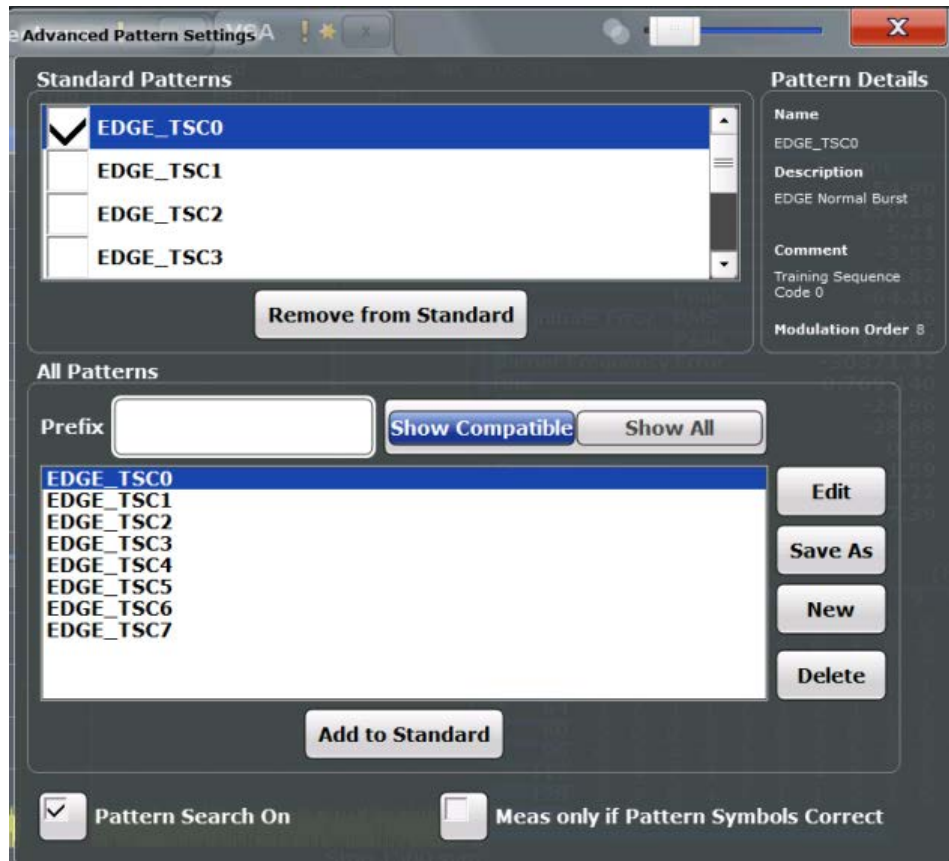
Indicates whether a pattern was found in the currently captured data.

## 5.7.3 Pattern Configuration

For common signal standards, the patterns to be searched for in the captured signal are predefined in the VSA application. In addition, new patterns can be defined and assigned to a signal standard manually.

Patterns are configured in the "Advanced Pattern Settings" dialog box which is displayed when you do one of the following:

- Select the "Pattern Config" softkey in the main VSA menu.
- In the "Signal Description" dialog box, switch to the "Signal Structure" tab and select the "Pattern Config" button.



Standard Patterns.....165

Removing patterns from a standard.....165

Adding patterns to a standard.....166

Displaying available patterns.....166

    L Prefix.....166

    L Show Compatible/ Show All.....166

Edit.....166

Save As.....166

New.....166

Delete.....167

Pattern details.....167

Pattern Search On.....167

Meas only if Pattern Symbols Correct.....167

**Standard Patterns**

The "Standard Patterns" are the patterns assigned to the currently selected standard. You can add existing patterns to the standard or remove patterns already assigned to the standard.

**Removing patterns from a standard**

Removes the assignment of the selected patterns to the standard. The patterns are removed from the "Standard Patterns" list, but not deleted.

SCPI command:

[SENSe:] DDEMod: SEARch: SYNC: PATtern: REMove on page 310

**Adding patterns to a standard**

Adds the selected patterns in the list of available patterns ("All Patterns") to the list of assigned patterns ("Standard Patterns").

For details see ["To add a predefined pattern to a standard"](#) on page 205.

SCPI command:

[\[SENSe:\] DDEMod:SEARCh:SYNC:PATtern:ADD](#) on page 310

**Displaying available patterns**

The "All Patterns" list contains the patterns available in the VSA application.

You can assign available patterns to the selected standard, edit existing or define new patterns. For details on managing standard patterns, see [chapter 7.2.2.3, "How to Manage Patterns"](#), on page 207

The list can be filtered using the following functions:

**Prefix ← Displaying available patterns**

Shows only patterns that contain the specified prefix.

**Show Compatible/ Show All ← Displaying available patterns**

Shows only patterns that are compatible to the selected modulation mode or all patterns (regardless of the selected standard).

**Edit**

Opens the "Edit Pattern" dialog box to edit the pattern definition. See [chapter 5.7.4, "Pattern Definition"](#), on page 167.

For details on defining a pattern, see [example "Defining a pattern"](#) on page 207.

SCPI command:

[\[SENSe:\] DDEMod:SEARCh:SYNC:NAME](#) on page 309

[\[SENSe:\] DDEMod:SEARCh:SYNC:COMMeNt](#) on page 308

[\[SENSe:\] DDEMod:SEARCh:SYNC:DATA](#) on page 309

[\[SENSe:\] DDEMod:SEARCh:SYNC:TEXT](#) on page 310

**Save As**

Saves a copy of an existing pattern under a new name.

SCPI command:

[\[SENSe:\] DDEMod:SEARCh:SYNC:COpy](#) on page 308

**New**

Opens the "Pattern" dialog box to create a new pattern definition. See [chapter 5.7.4, "Pattern Definition"](#), on page 167.

For details on defining a pattern, see [chapter 7.2.2.2, "How to Define a New Pattern"](#), on page 206.

SCPI command:

[\[SENSe:\] DDEMod:SEARCh:SYNC:NAME](#) on page 309

[\[SENSe:\] DDEMod:SEARCh:SYNC:COMMeNt](#) on page 308

[\[SENSe:\] DDEMod:SEARCh:SYNC:DATA](#) on page 309

[\[SENSe:\] DDEMod:SEARCh:SYNC:TEXT](#) on page 310

**Delete**

Deletes the selected patterns. Any existing assignments to other standards are removed.

SCPI command:

[\[SENSe:\] DDEMod:SEARCh:SYNC:DELeTe](#) on page 308

**Pattern details**

Pattern details for the currently focussed pattern are displayed at the upper right-hand side of the dialog box. You can refer to these details, for example, when you want to add a new pattern to the standard and want to make sure you have selected the correct one.

**Pattern Search On**

If enabled, the VSA application searches for the selected pattern. This setting is identical to the setting in the "Pattern Search" dialog box (see ["Enabling Pattern Searches"](#) on page 163).

SCPI command:

[\[SENSe:\] DDEMod:SEARCh:SYNC:STATe](#) on page 307

**Meas only if Pattern Symbols Correct**

If enabled, measurement results are only displayed (and are only averaged) if a valid pattern has been found. When measuring signals that contain a pattern and are averaged over several measurements, it is recommended that you enable this option so that erroneous measurements do not affect the result of averaging.

SCPI command:

[\[SENSe:\] DDEMod:SEARCh:SYNC:MODE](#) on page 307

## 5.7.4 Pattern Definition

New patterns can be defined and then assigned to a standard. Patterns are defined in the "New Pattern" dialog box which is displayed when you select the "New" button in the "Advanced Pattern Settings" dialog box.





For details on defining a pattern, see [chapter 7.2.2.2, "How to Define a New Pattern"](#), on page 206.

Name.....168  
 Description.....168  
 Mod. order.....169  
 Symbols.....169  
     L Symbol format.....169  
     L Adding symbols.....169  
     L Removing symbols.....169  
 Comment.....169

**Name**

Pattern name that will be displayed in selection list

SCPI command:

[SENSe:] DDEMod: SEARCh: SYNC: NAME on page 309

**Description**

Optional description of the pattern which is displayed in the pattern details

SCPI command:

[SENSe:] DDEMod: SEARCh: SYNC: TEXT on page 310



**Mod. order**

The order of modulation, e.g. 8 for an 8-PSK.

SCPI command:

[\[SENSe:\] DDEMod:SEARCh:SYNC:NState](#) on page 309

**Symbols**

The pattern definition is a symbol table consisting of one or more symbols. The number of symbols is indicated as the "Size" to the left of the symbol table.

A scrollbar beneath the input area allows you to scroll through the table for long patterns. The numbers beneath the scrollbar indicate the sequential number of the following symbols, from left to right:

- the first symbol
- the currently selected symbol
- the last symbol

SCPI command:

[\[SENSe:\] DDEMod:SEARCh:SYNC:DATA](#) on page 309

**Symbol format ← Symbols**

Defines the format in which each symbol is defined: hexadecimal, decimal or binary

**Adding symbols ← Symbols**

Adds a new symbol in the symbol table to the left of the currently selected symbol.

**Removing symbols ← Symbols**

Removes the currently selected symbol in the symbol table.

**Comment**

Optional comment for the pattern, displayed in the pattern details (kept for compatibility with FSQ)

SCPI command:

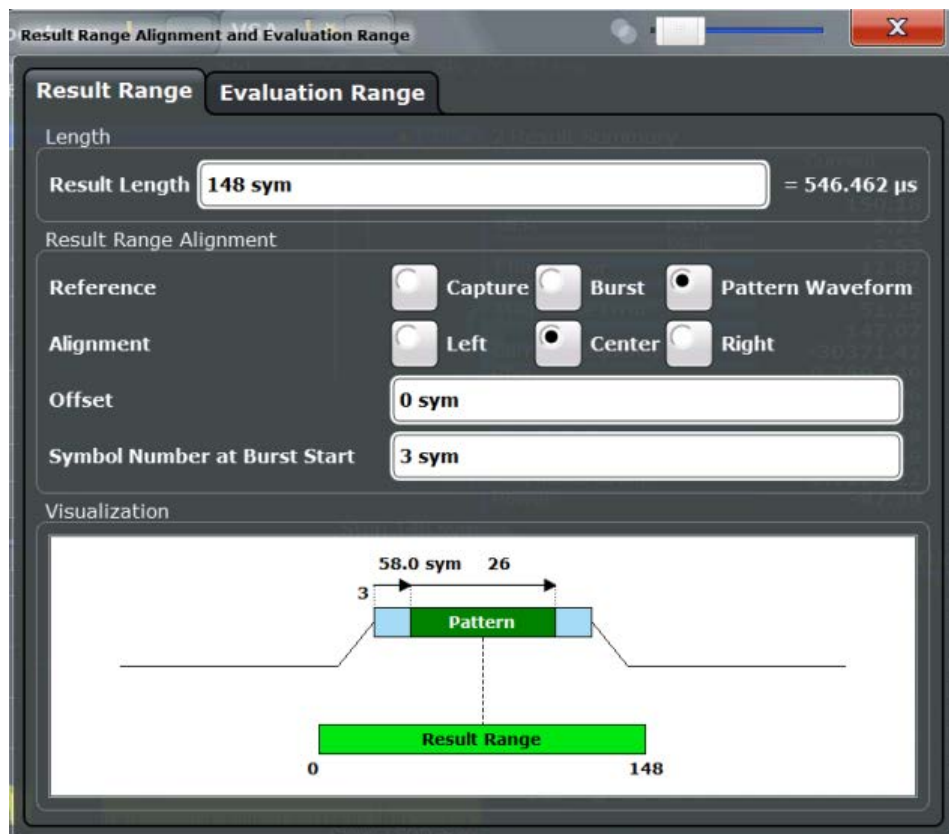
[\[SENSe:\] DDEMod:SEARCh:SYNC:COMMeNt](#) on page 308

## 5.8 Result Range Configuration

The result range determines which part of the capture buffer, burst or pattern is displayed. For more information, see [chapter 4.6, "Measurement Ranges"](#), on page 111.

A visualization of the result display with the current settings is displayed in the visualization area at the bottom of the dialog box.

The result range settings are displayed when you select the "Cut Result Ranges" button in the "Overview" or the "Range Settings" softkey in the main VSA menu.



Result Length.....170  
 Reference.....170  
 Alignment.....171  
 Offset.....171  
 Symbol Number at <Reference> Start.....171

**Result Length**

Defines the number of symbols that are to be demodulated. All traces over time are displayed over the result range.

SCPI command:

[SENSe:] DDEMod:TIME on page 312

**Reference**

Defines the reference for the result range alignment.

The result of the current setting is displayed in the visualization area of the dialog box.

- "Capture" the capture buffer
- "Burst" the detected burst
- "Pattern" the detected pattern

SCPI command:

CALCulate<n>:TRACe<t>:ADJust[:VALue] on page 311

**Alignment**

Defines the type of alignment of the result range to the reference source. The result of the current setting is displayed in the visualization area of the dialog box.

SCPI command:

`CALCulate<n>:TRACe<t>:ADJust:ALIGNment[:DEFault]` on page 310

**Offset**

Defines the offset of the result range to the alignment reference. The result of the current setting is displayed in the visualization area of the dialog box.

**Note:** Note the following restrictions to this parameter:

- An offset  $< 0$  is not possible if you align the result range to the left border of the capture buffer.
- An offset that moves the pattern outside the result range is not allowed. For example, if you align the result to the left border of the pattern, only offsets  $\leq 0$  are allowed. Otherwise, you would never be able to find the pattern within the result range.

SCPI command:

`CALCulate<n>:TRACe<t>:ADJust:ALIGNment:OFFSet` on page 311

**Symbol Number at <Reference> Start**

Defines the number of the symbol which marks the beginning of the alignment reference source (burst, capture buffer or pattern). The result of the current setting is displayed in the visualization area of the dialog box.

In effect, this setting defines an offset of the x-axis (in addition to the one defined for the signal structure, see "Offset" on page 133).

**Note:** When you define the "Symbol Number at <Reference> Start" remember to take the offset defined for the signal structure into consideration (see "Offset" on page 133). The "Symbol Number at Pattern Start" refers to the first symbol of the pattern offset, not the first symbol of the pattern.

SCPI command:

`DISPlay[:WINDow<n>]:TRACe<t>:X[:SCALE]:VOFFset` on page 312

## 5.9 Demodulation Settings

During demodulation of the vector signal some undesired effects that may occur during transmission can be compensated for. Furthermore, you can influence the synchronization process.

- [Demodulation - Compensation](#)..... 172
- [Advanced Demodulation \(Synchronization\)](#)..... 175

### 5.9.1 Demodulation - Compensation



Note that compensation for all the listed distortions can result in lower EVM values.

Demodulation settings are displayed when you select the "Demodulation" button in the "Overview" or the "Demod/Meas Filter" softkey in the main VSA menu.

A live preview of the constellation with the current settings is displayed in the preview area at the bottom of the dialog box. The preview area is not editable directly.

Demodulation settings depend on the used modulation.

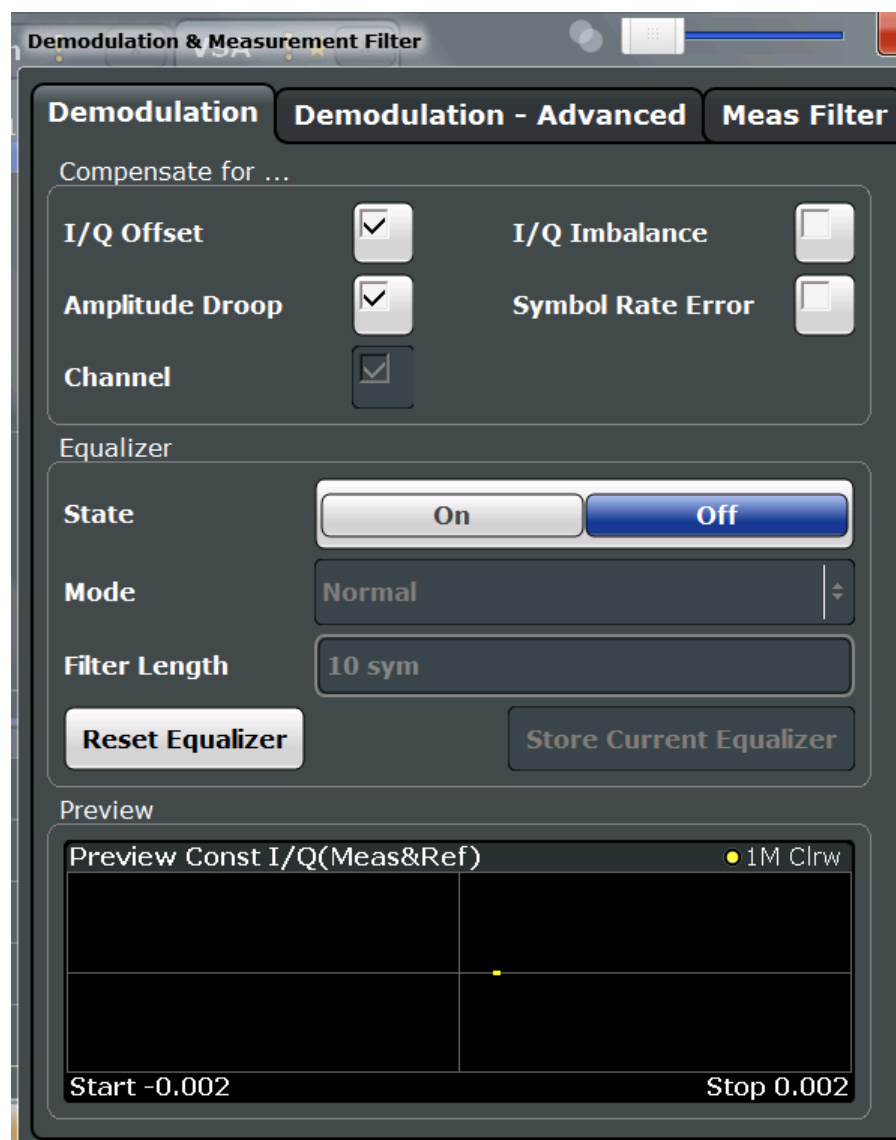


Fig. 5-2: Demodulation settings for PSK, MSK and QAM modulation

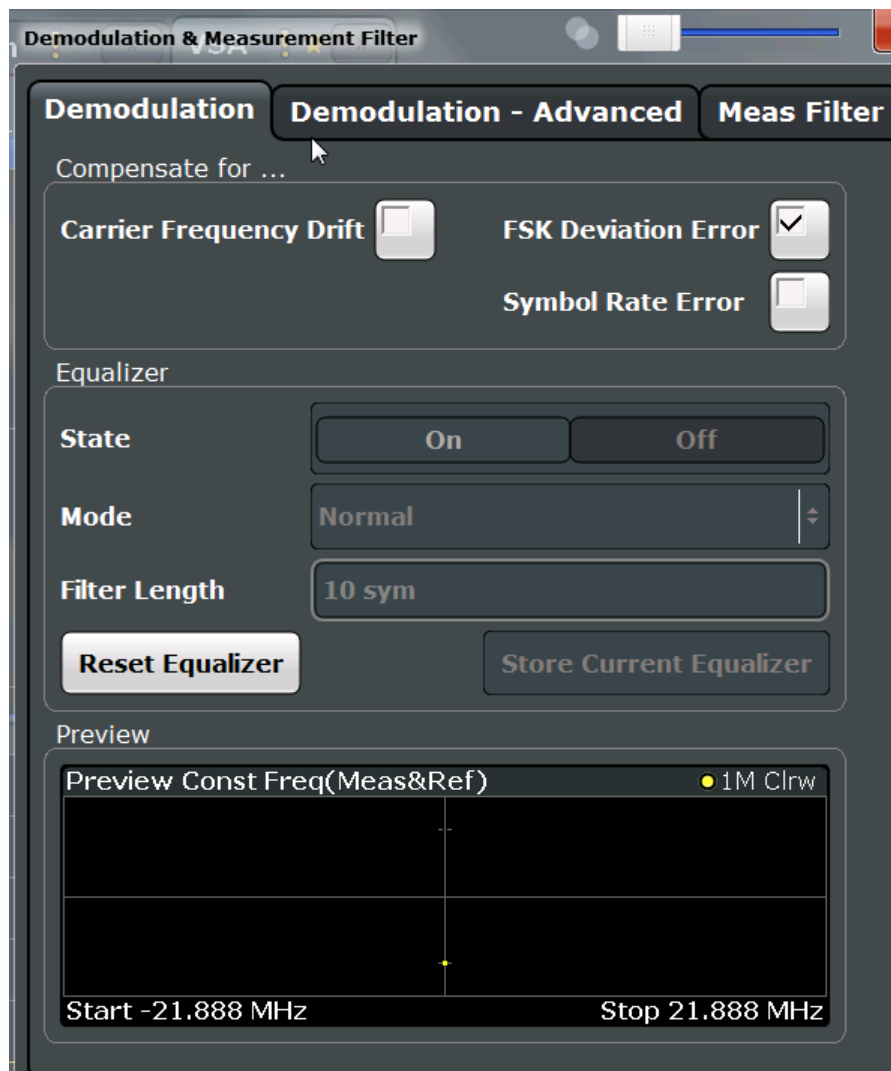


Fig. 5-3: Demodulation settings for FSK modulation

Compensate for... (PSK, MSK, ASK, QAM).....	173
Compensate for... (FSK).....	174
Equalizer Settings.....	174
L State.....	174
L Mode.....	174
L Filter Length.....	175
L Reset Equalizer.....	175
L Store/Load Current Equalizer.....	175

**Compensate for... (PSK, MSK, ASK, QAM)**

If enabled, compensation for various effects is taken into consideration during demodulation. Thus, these distortions are not shown in the calculated error values.

**Note:** Note that compensation for all the listed distortions can result in lower EVM values.

- I/Q Offset (default: on)
- I/Q Imbalance

- Amplitude Droop (default: on)
- Symbol Rate Error
- Channel (default: on)

Note that channel distortion can only be determined if the equalizer is on (see "State" on page 174). Thus, compensation can only be disabled if the equalizer is on.

By default, channel compensation is enabled to improve accuracy of the error results. If compensation is disabled, the EVM is calculated from the original input signal with channel distortions.

For details on these effects see [chapter 4.5.1.3, "Modulation Errors"](#), on page 98.

SCPI command:

[\[SENSe:\]DDEMod:NORMAlize:IQOFFset](#) on page 319

[\[SENSe:\]DDEMod:NORMAlize:IQIMbalance](#) on page 319

[\[SENSe:\]DDEMod:NORMAlize:ADRoop](#) on page 318

[\[SENSe:\]DDEMod:NORMAlize:SRERror](#) on page 320

[\[SENSe:\]DDEMod:NORMAlize:CHANnel](#) on page 319

### Compensate for... (FSK)

If enabled, compensation for various effects is taken into consideration during demodulation. Thus, these distortions are not shown in the calculated error values.

- Carrier Frequency Drift
- FSK Deviation Error
- Symbol Rate Error

For details on these effects see [chapter 4.5.2.3, "Modulation Errors"](#), on page 110.

SCPI command:

[\[SENSe:\]DDEMod:NORMAlize:CFDRift](#) on page 319

[\[SENSe:\]DDEMod:NORMAlize:FDERror](#) on page 319

[\[SENSe:\]DDEMod:NORMAlize:SRERror](#) on page 320

### Equalizer Settings

The equalizer can compensate for a distorted transmission of the input signal or improve accuracy in estimating the reference signal.

For details see [chapter 4.4.5, "The Equalizer"](#), on page 93.

#### State ← Equalizer Settings

Activates or deactivates the equalizer to compensate for a distorted channel.

SCPI command:

[\[SENSe:\]DDEMod:EQUalizer\[:STATe\]](#) on page 317

#### Mode ← Equalizer Settings

Defines the operating mode of the equalizer.

"Normal" Determines the filter values from the difference between the ideal (reference) signal and the measured signal. Normal mode is sufficient for small distortions and performance remains high.

"Tracking"	The results of the equalizer in the previous sweep are considered to calculate the new filter until adequate results are obtained. This "learning" effect allows for powerful removal of larger distortions within a minimum of sweeps. During the tracking phase calculation of the equalizer requires additional processing time.
"Freeze"	The filter is no longer changed, the current equalizer values are used for subsequent sweeps.
"User"	A user-defined equalizer loaded from a file is used.
"Averaging"	The results of the equalizer in all previous sweeps (since the instrument was switched on or the equalizer was reset) are considered to calculate the new filter. To start a new averaging process, select the <a href="#">Reset Equalizer</a> button. Calculation of the equalizer requires additional processing time.

SCPI command:

[\[SENSe:\]DDEMod:EQUalizer:MODE](#) on page 315

#### **Filter Length ← Equalizer Settings**

Defines the length of the equalizer in symbols. The longer the equalizer, the more accurate the filter becomes and the more distortion can be compensated. However, this requires extended calculation time. The shorter the filter length, the less calculation time is required during the equalizer's tracking or averaging phase.

SCPI command:

[\[SENSe:\]DDEMod:EQUalizer:LENGth](#) on page 314

#### **Reset Equalizer ← Equalizer Settings**

Deletes the data of the currently selected equalizer. After deletion, averaging and tracking starts anew.

This is useful in the rare case that calculation takes a wrong symbol decision into consideration and distorts the signal such that the original signal can no longer be determined.

SCPI command:

[\[SENSe:\]DDEMod:EQUalizer:RESet](#) on page 316

#### **Store/Load Current Equalizer ← Equalizer Settings**

Saves the current equalizer results to a file, or loads a user-defined equalizer.

The equalizer [Mode](#) must be set to `USER` in order to load a file.

SCPI command:

[\[SENSe:\]DDEMod:EQUalizer:SAVE](#) on page 316

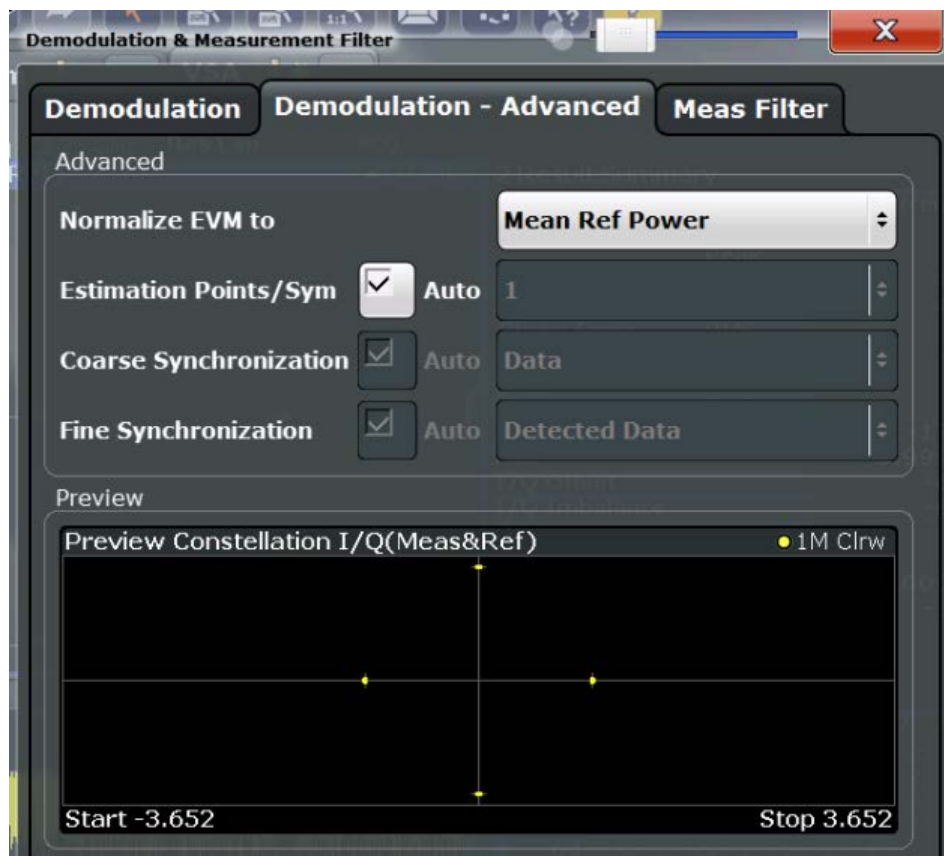
[\[SENSe:\]DDEMod:EQUalizer:LOAD](#) on page 315

## **5.9.2 Advanced Demodulation (Synchronization)**

You can influence the synchronization process and calculation of error values during demodulation.

Advanced demodulation settings are displayed when you select the "Demodulation" button in the "Overview" or the "Demod/Meas Filter" softkey in the main VSA menu and then switch to the "Demodulation - Advanced" tab.

A live preview of the constellation with the current settings is displayed in the preview area at the bottom of the dialog box. The preview area is not editable directly.



Normalize EVM to.....176  
 Estimation Points/Sym.....177  
 Coarse Synchronization.....177  
 Fine Synchronization.....178  
 If SER ≤.....179  
 Offset EVM.....179

**Normalize EVM to**

Normalizes the EVM to the specified power value.

This setting is not available for MSK or FSK modulation.

- **Max Ref Power**  
Maximum power of the reference signal at the symbol instants.
- **Mean Ref Power**  
mean power of the reference signal at the symbol instants.
- **Mean Constellation Power**  
Mean expected power of the measurement signal at the symbol instants
- **Max Constellation Power**



The maximum expected power of the measurement signal at the symbol instants  
SCPI command:

[SENSe:] DDEMod:ECALc [:MODE] on page 313

### Estimation Points/Sym

During synchronization, the measurement signal is matched to the reference signal and various signal parameters are calculated. You can define how many sample points are used for this calculation at each symbol.

For more information on estimation points per symbol see [chapter 4.7, "Display Points vs Estimation Points per Symbol"](#), on page 115.

You can set the estimation points manually or let the VSA application decide how many estimation points to use.

If automatic mode is enabled, the VSA application uses the following settings, depending on the modulation type:

Modulation	Est. Points
PSK, QAM	1
Offset QPSK	2
FSK, MSK	Capture Oversampling

For manual mode, the following settings are available:

- "1" the estimation algorithm takes only the symbol time instants into account
- "2" two points per symbol instant are used (required for Offset QPSK)
- "Capture Over-sampling" the number of samples per symbol defined in the signal capture settings is used (see ["Sample Rate"](#) on page 153), i.e. all sample time instants are weighted equally

SCPI command:

[SENSe:] DDEMod:EPRate:AUTO on page 314

[SENSe:] DDEMod:EPRate [:VALue] on page 314

### Coarse Synchronization

It is not only possible to check whether the pattern is part of the signal, but also to use the pattern for synchronization, in order to obtain the correct reference signal.

For details on synchronization see [chapter 4.4, "Overview of the Demodulation Process"](#), on page 84.

If "Auto" mode is selected, the detected data is used. In manual mode you can select one of the following settings:

- "Data" (Default): the detected data is used for synchronization, i.e. unknown symbols  
Use this setting if no pattern is available or if the pattern is short or does not have suitable synchronization properties, e.g. a pattern that consists of only one repeated symbol.

"Pattern" Known symbols from a defined pattern are used for synchronization. Depending on the signal, using the pattern can speed up your measurement considerably and make it more robust against high carrier frequency offsets. Make sure that the pattern is suitable for synchronization, e.g. a GSM pattern.

SCPI command:

[\[SENSe:\] DDEMod:SEARCh:PATtern:SYNC:AUTO](#) on page 320

[\[SENSe:\] DDEMod:SEARCh:PATtern:SYNC\[:STATe\]](#) on page 320

### Fine Synchronization

In addition to the coarse synchronization used for symbol decisions, a fine synchronization is available to calculate various results from the reference signal, e.g. the EVM. However, when the signal is known to have a poor transmission quality or has a high noise level, false symbol decisions are more frequent, which may cause spikes in the EVM results.

To improve these calculations the reference signal can be estimated from a smaller area that includes a known symbol sequence in the input signal. In this case, the results for the limited reference area are more precise, at the cost of less accurate results outside this area. Thus, the result range should be set to the length of the reference area. The reference area can be defined either using a pattern or using a known data sequence from a Known Data file. If no predefined data sequences are available for the signal, the detected data is used by default.

If "Auto" mode is selected and a Known Data file has been loaded and activated for use, the known data sequences are used. Otherwise, the detected data is used.

**Note:** You can define a maximum symbol error rate (SER) for the known data in reference to the evaluated data. If the SER of the known data exceeds this limit, the default synchronization using the detected data is performed.

"Known Data" The reference signal is defined as the data sequence from the loaded Known Data file that most closely matches the measured data.

"Pattern" The reference signal is estimated from the defined pattern.

"Detected Data" (Default) The reference signal is estimated from the detected data.

SCPI command:

[\[SENSe:\] DDEMod:FSYNc:AUTO](#) on page 317

[\[SENSe:\] DDEMod:FSYNc\[:MODE\]](#) on page 317

[\[SENSe:\] DDEMod:FSYNc:RESult?](#) on page 317

**If SER ≤**

This setting is only available if "Known Data" is selected for "Fine Synchronization". You can define a maximum symbol error rate for the known data in reference to the evaluated data. Thus, if a wrong file was mistakenly loaded or the file proves to be unsuitable, it is not used for synchronization. Otherwise the results would be strongly distorted. If the SER of the known data exceeds this limit, the default synchronization using the detected data is performed.

SCPI command:

[SENSe:] DDEMod:FSYNc:LEVel on page 317

**Offset EVM**

The offset EVM is only available for Offset QPSK modulated signals.

Unlike QPSK modulation, the Q component of Offset QPSK modulation is delayed by half a symbol period against the I component in the time domain. The symbol time instants of the I and the Q component therefore do not coincide.

The offset EVM controls the calculation of all results that are based on the error vector. It affects the EVM, Real/Imag and Vector I/Q result displays as well as the EVM results in the Result Summary (EVM and MER).

You can configure the way the VSA application calculates the error vector results.

If "Offset EVM" is disabled, the VSA application subtracts the measured signal from the reference signal to calculate the error vector. This method results in the fact that the error vector contains two symbol instants per symbol period: one that corresponds to the I component and one that corresponds to the Q component.

If "Offset EVM" is enabled, however, the VSA application compensates the delay of the Q component with respect to the I component in the measurement signal as well as the reference signal **before** calculating the error vector. That means that the error vector contains only one symbol instant per symbol period.

SCPI command:

[SENSe:] DDEMod:ECALc:OFFSet on page 313

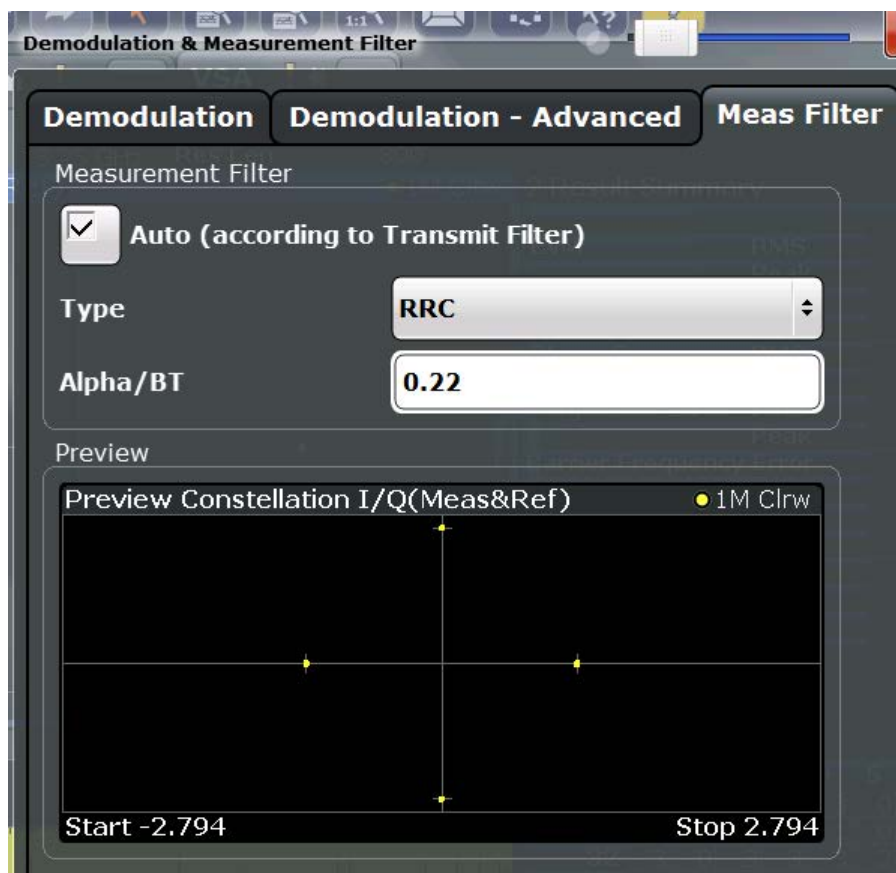
## 5.10 Measurement Filter Settings

The measurement filter can be used to filter both the measured signal and the reference signal, and thus the error vector. You can configure the measurement filter to be used.

For more information on measurement filters see [chapter 4.1.4, "Measurement Filters"](#), on page 53.

Measurement filter settings are displayed when you select the "Meas Filter" button in the "Overview" or the "Demod/Meas Filter" softkey in the main VSA menu and then switch to the "Meas Filter" tab.

A live preview of the constellation with the current settings is displayed in the preview area at the bottom of the dialog box. The preview area is not editable directly.



Using the Transmit Filter as a Measurement Filter (Auto).....180  
 Type.....180  
     L Load User Filter.....181  
     L Alpha/BT.....181

**Using the Transmit Filter as a Measurement Filter (Auto)**

If the "Auto" option is enabled, the measurement filter is defined automatically depending on the transmit filter specified in the "Modulation" settings (see "Transmit Filter Type" on page 130).

**Note:** If a user-defined transmit filter is selected and the measurement filter is defined automatically, a Low-ISI measurement filter according to the selected user filter is calculated and used.

SCPI command:

[SENSe:] DDEMod:MFILter:AUTO on page 321

**Type**

Defines the measurement filter type, if the [Using the Transmit Filter as a Measurement Filter \(Auto\)](#) setting is not enabled.

"<Predefined Filter>" An overview of available measurement filters is provided in [chapter A.2.2, "Measurement Filters"](#), on page 404.

"User" User-defined filter.  
 Define the filter using the [Load User Filter](#) function or the `[SENSe:] DDEMod:MFILter:USER` command.  
 For more information on user-defined filters see [chapter 4.1.5, "Customized Filters"](#), on page 55.

"None" No measurement filter is used.

SCPI command:

`[SENSe:] DDEMod:MFILter[:STATe]` on page 321

To turn off the measurement filter.

`[SENSe:] DDEMod:MFILter:USER` on page 322

To use a user-defined filter.

`[SENSe:] DDEMod:MFILter:NAME` on page 321

To define the name of the measurement filter.

#### **Load User Filter ← Type**

Opens a file-selection dialog box to select the user-defined measurement filter to be used.

This setting is only available if "User" is selected as the "Filter Type".

For detailed instructions on working with user-defined filters see [chapter 7.2.1, "How to Select User-Defined Filters"](#), on page 204.

SCPI command:

`[SENSe:] DDEMod:MFILter:USER` on page 322

#### **Alpha/BT ← Type**

Defines the roll-off factor (Alpha) or the filter bandwidth (BT).

The roll-off factor or filter bandwidth are available for RC, RRC and Gauss filters.

If the measurement mode is automatically selected according to the transmit filter, this setting is identical to the "Alpha/BT" value in the modulation settings (see ["Alpha/BT"](#) on page 130).

SCPI command:

Measurement filter: `[SENSe:] DDEMod:MFILter:ALPHA` on page 321

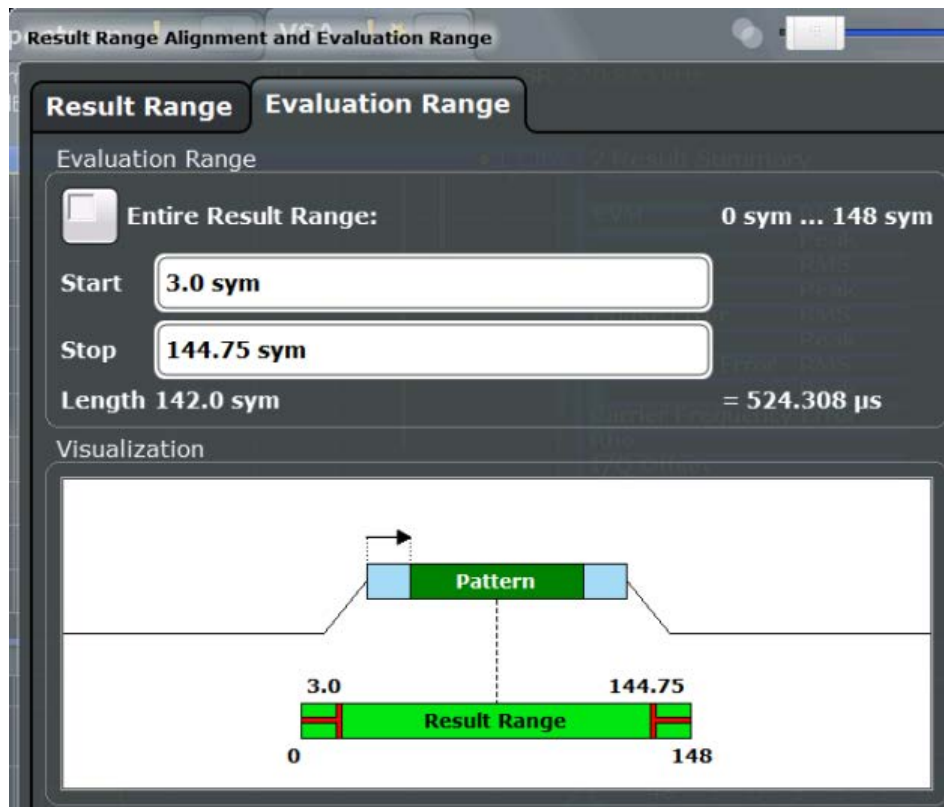
Transmit filter: `[SENSe:] DDEMod:TFILter:ALPHA` on page 274

## 5.11 Evaluation Range Configuration

The evaluation range defines which range of the result is to be evaluated - either the entire result range or only a specified part of it. The calculated length of the specified range is indicated beneath the entries.

A visualization of the evaluation range (in relation to the result range) with the current settings is displayed at the bottom of the dialog box. The green bar below the trace indicates the defined result range, indented red lines indicate defined start and stop symbols (see ["Evaluation range display"](#) on page 114). The visualization is not editable directly.

The evaluation range settings are displayed when you select the "Evaluation Range" button in the "Overview" or the "Range Settings" softkey in the main VSA menu and then switch to the "Evaluation Range" tab.



For details on the evaluation range see [chapter 4.6, "Measurement Ranges"](#), on page 111.

For an example on setting the evaluation range see [chapter 8.3.5, "Setting the Evaluation Range"](#), on page 234.

<a href="#">Evaluating the Entire Result Range</a> .....	182
<a href="#">Start / Stop</a> .....	182

**Evaluating the Entire Result Range**

If enabled, the entire result range is evaluated.

If disabled, you can define a specific part of the result range to be evaluated.

SCPI command:

`CALCulate<n>:ELIN<startstop>:STATe` on page 322

**Start / Stop**

Defines the symbol in the result range at which evaluation is started and stopped. The start and stop symbols themselves are included in the evaluation range.

**Note:** Note that the start and stop values are defined with respect to the x-axis including an optional offset defined via the [Symbol Number at <Reference> Start](#) parameter.

SCPI command:

[CALCulate<n>:ELIN<startstop>\[:VALue\]](#) on page 323

## 5.12 Adjusting Settings Automatically

Some settings can be adjusted by the R&S FSW automatically according to the current measurement settings. In order to do so, a measurement is performed. The duration of this measurement can be defined automatically or manually.

To activate the automatic adjustment of a setting, select the corresponding function in the AUTO SET menu or in the configuration dialog box for the setting, where available.

<a href="#">Setting the Reference Level Automatically (Auto Level)</a> .....	183
<a href="#">Resetting the Automatic Measurement Time (Meastime Auto)</a> .....	183
<a href="#">Changing the Automatic Measurement Time (Meastime Manual)</a> .....	183
<a href="#">Upper Level Hysteresis</a> .....	184
<a href="#">Lower Level Hysteresis</a> .....	184
<a href="#">Auto Scale Once/Auto Scale Window</a> .....	184
<a href="#">Auto Scale All</a> .....	184

### Setting the Reference Level Automatically (Auto Level)

Automatically determines the optimal reference level for the current input data. At the same time, the internal attenuators and the preamplifier are adjusted so the signal-to-noise ratio is optimized, while signal compression, clipping and overload conditions are minimized.

In order to do so, a level measurement is performed to determine the optimal reference level.

You can change the measurement time for the level measurement if necessary (see "[Changing the Automatic Measurement Time \(Meastime Manual\)](#)" on page 183).

SCPI command:

[\[SENSe:\]ADJust:LEVel](#) on page 326

### Resetting the Automatic Measurement Time (Meastime Auto)

Resets the measurement duration for automatic settings to the default value.

SCPI command:

[\[SENSe:\]ADJust:CONFigure:DURation:MODE](#) on page 324

### Changing the Automatic Measurement Time (Meastime Manual)

This function allows you to change the measurement duration for automatic setting adjustments. Enter the value in seconds.

SCPI command:

[\[SENSe:\]ADJust:CONFigure:DURation:MODE](#) on page 324

[\[SENSe:\]ADJust:CONFigure:DURation](#) on page 324

**Upper Level Hysteresis**

When the reference level is adjusted automatically using the [Setting the Reference Level Automatically \(Auto Level\)](#) function, the internal attenuators and the preamplifier are also adjusted. In order to avoid frequent adaptation due to small changes in the input signal, you can define a hysteresis. This setting defines an upper threshold the signal must exceed (compared to the last measurement) before the reference level is adapted automatically.

SCPI command:

`[SENSe:]ADJust:CONFigure:HYSTeresis:UPPer` on page 325

**Lower Level Hysteresis**

When the reference level is adjusted automatically using the [Setting the Reference Level Automatically \(Auto Level\)](#) function, the internal attenuators and the preamplifier are also adjusted. In order to avoid frequent adaptation due to small changes in the input signal, you can define a hysteresis. This setting defines a lower threshold the signal must fall below (compared to the last measurement) before the reference level is adapted automatically.

SCPI command:

`[SENSe:]ADJust:CONFigure:HYSTeresis:LOWer` on page 325

**Auto Scale Once/Auto Scale Window**

If enabled, both the x-axis and y-axis are automatically adapted to the current measurement results (only once, not dynamically) in the selected window.

To adapt the range of all screens together, use the [Auto Scale All](#) function.

SCPI command:

`DISPlay[:WINDow<n>]:TRACe:Y[:SCALe]:AUTO ONCE` on page 324

**Auto Scale All**

Adapts the x-axis and y-axis to the current measurement values (only once, not dynamically) in all measurement windows.

SCPI command:

`DISPlay[:WINDow<n>]:TRACe<t>:Y[:SCALe]:AUTO:ALL` on page 324



## 6 Analysis

General result analysis settings concerning the trace, markers, windows etc. can be configured via the "Analysis" button in the "Overview". They are identical to the analysis functions in the base unit except for the special window functions.



### Window-specific configuration

The settings in the "Analysis" dialog box are specific to the selected window. Thus, the "Analysis" button is only available in the "Overview" if the "Specifics for" option is enabled. To configure the settings for a different VSA window, select the window outside the displayed dialog box, or select the window from the "Specifics for" selection list in the dialog box.

- [Trace Settings](#).....185
- [Trace Export Settings](#).....188
- [Markers](#).....189
- [Modulation Accuracy Limit Lines](#).....194
- [Display and Window Configuration](#).....196
- [Zoom Functions](#).....199

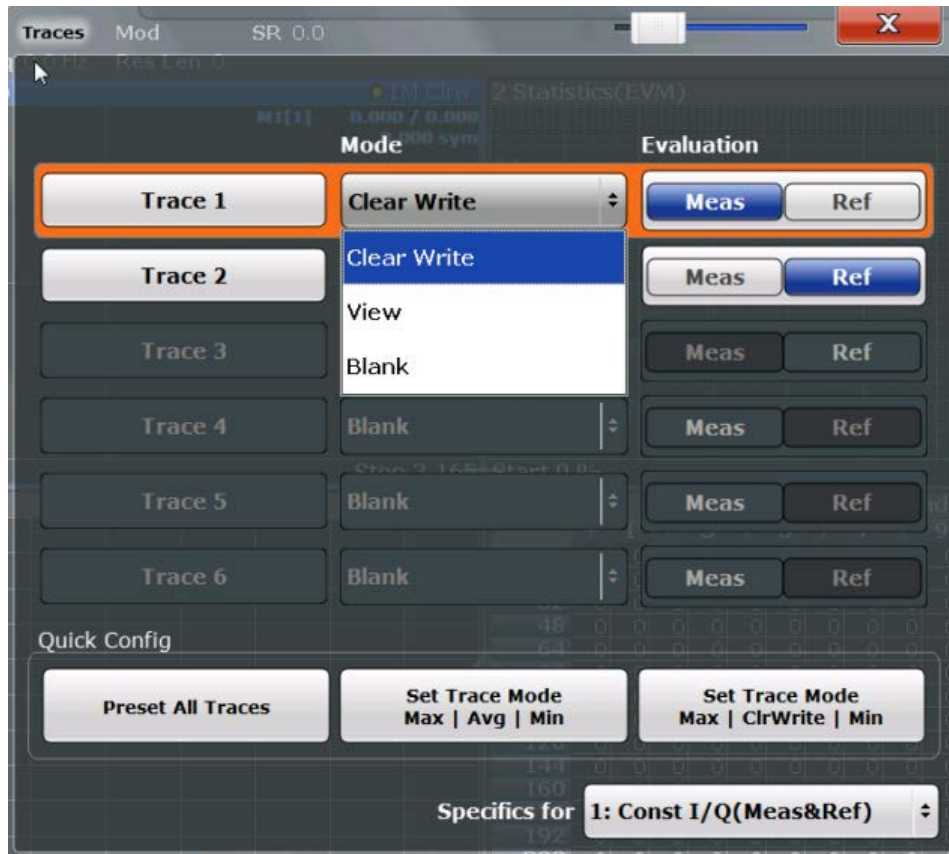
### 6.1 Trace Settings

The trace settings determine how the measured data is analyzed and displayed in the window. Depending on the result display, between 1 and 6 traces may be displayed.

Trace settings can be configured via the TRACE key, in the "Traces" dialog box, or in the vertical "Traces" tab of the "Analysis" dialog box.



Trace data can also be exported to an ASCII file for further analysis. For details see [chapter 6.2, "Trace Export Settings"](#), on page 188.



Trace 1/Trace 2/Trace 3/Trace 4/Trace 5/Trace 6..... 186  
 Trace Mode..... 186  
 Evaluation..... 187  
 Predefined Trace Settings - Quick Config..... 187  
 Trace 1/Trace 2/Trace 3/Trace 4 (Softkeys)..... 187

**Trace 1/Trace 2/Trace 3/Trace 4/Trace 5/Trace 6**

Selects the corresponding trace for configuration. The currently selected trace is highlighted orange.

SCPI command:

[DISPlay\[:WINDow<n>\]:TRACe<t>\[:STATe\]](#) on page 333

Selected via numeric suffix of TRACe<t> commands

**Trace Mode**

Defines the update mode for subsequent traces.

The available trace modes depend on the selected result display. Not all evaluations support all trace modes.

"Clear Write" Overwrite mode: the trace is overwritten by each sweep. This is the default setting.  
 The "Detector" is automatically set to "Auto Peak".

"Max Hold"	The maximum value is determined over several sweeps and displayed. The R&S FSW saves the sweep result in the trace memory only if the new value is greater than the previous one. The "Detector" is automatically set to "Positive Peak".
"Min Hold"	The minimum value is determined from several measurements and displayed. The R&S FSW saves the sweep result in the trace memory only if the new value is lower than the previous one. The "Detector" is automatically set to "Negative Peak".
"Average"	The average is formed over several sweeps. The <a href="#">Statistic Count</a> determines the number of averaging procedures. The "Detector" is automatically set to "Sample".
"View"	The current contents of the trace memory are frozen and displayed.
"Blank"	Removes the selected trace from the display.

SCPI command:

[DISPlay\[:WINDow<n>\]:TRACe<t>:MODE](#) on page 333

### Evaluation

Defines whether the trace displays the evaluation of the measured signal or the reference signal (if "Meas & Ref Signal" is used as the evaluation data source, see ["Signal Source"](#) on page 197).

SCPI command:

[CALCulate<n>:TRACe<t>\[:VALue\]](#) on page 332

### Predefined Trace Settings - Quick Config

Commonly required trace settings have been predefined and can be applied very quickly by selecting the appropriate button.

Function	Trace Settings	
Preset All Traces	Trace 1:	Clear Write
	Traces 2-6:	Blank
Set Trace Mode Max   Avg   Min	Trace 1:	Max Hold
	Trace 2:	Average
	Trace 3:	Min Hold
	Traces 4-6:	Blank
Set Trace Mode Max   ClrWrite   Min	Trace 1:	Max Hold
	Trace 2:	Clear Write
	Trace 3:	Min Hold
	Traces 4-6:	Blank

### Trace 1/Trace 2/Trace 3/Trace 4 (Softkeys)

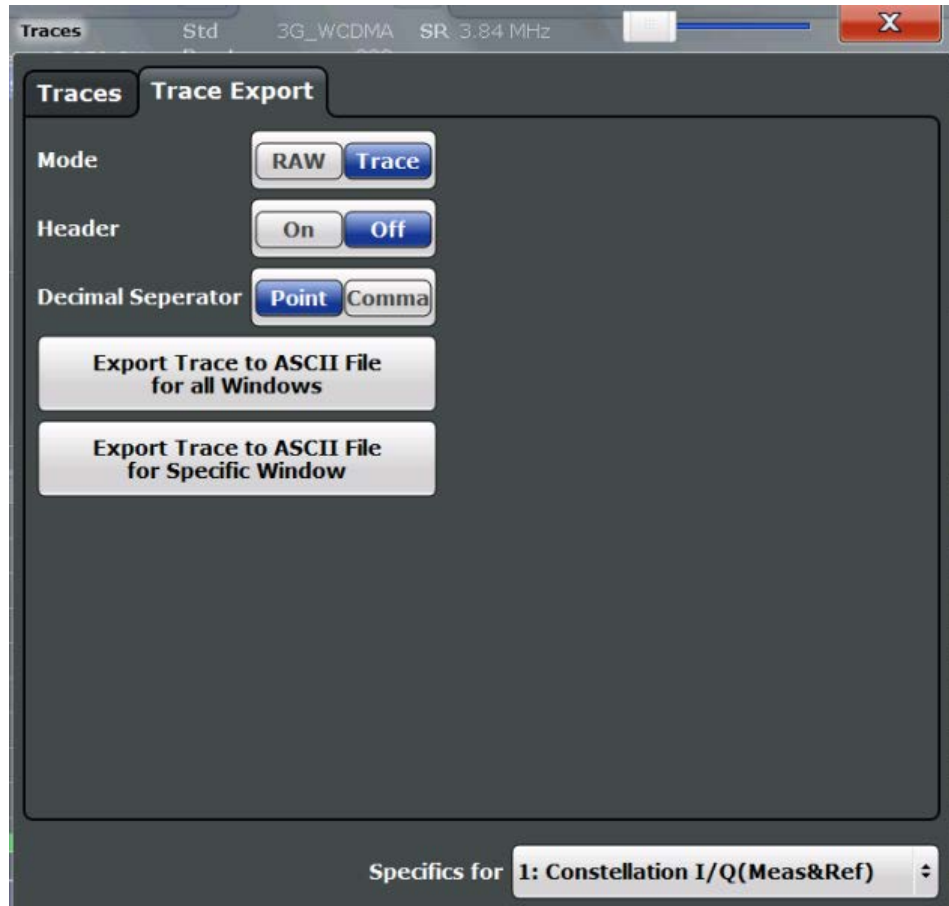
Displays the "Traces" settings and focuses the "Mode" list for the selected trace.

SCPI command:

[DISPlay\[:WINDow<n>\]:TRACe<t>\[:STATe\]](#) on page 333

## 6.2 Trace Export Settings

The captured (trace) data can also be exported to an ASCII file. The format of these files can be configured.



Data Export Mode.....	188
Header.....	188
Decimal Separator.....	189
Trace ASCII Export.....	189

### Data Export Mode

Defines whether raw I/Q data (as captured) or trace data (evaluated) is stored.

SCPI command:

[FORMat:DEXPort:MODE](#) on page 362

### Header

If enabled, a header with scaling information etc. is included in the file.

SCPI command:

[FORMat:DEXPort:HEADer](#) on page 362

**Decimal Separator**

Defines the decimal separator for floating-point numerals for the data export files. Evaluation programs require different separators in different languages.

SCPI command:

[FORMat:DEXPort:DSEParator](#) on page 362

**Trace ASCII Export**

Opens a file selection dialog box and saves the traces of the captured data in ASCII format to the specified file and directory.

Either the traces for the selected window only (see ["Specifics for"](#) on page 125) are exported, or the traces of all windows are exported, one after the other.

For details on the file format see [chapter A.3, "ASCII File Export Format for VSA Data"](#), on page 406.

SCPI command:

[MMEMory:STORe<n>:TRACe](#) on page 363

## 6.3 Markers

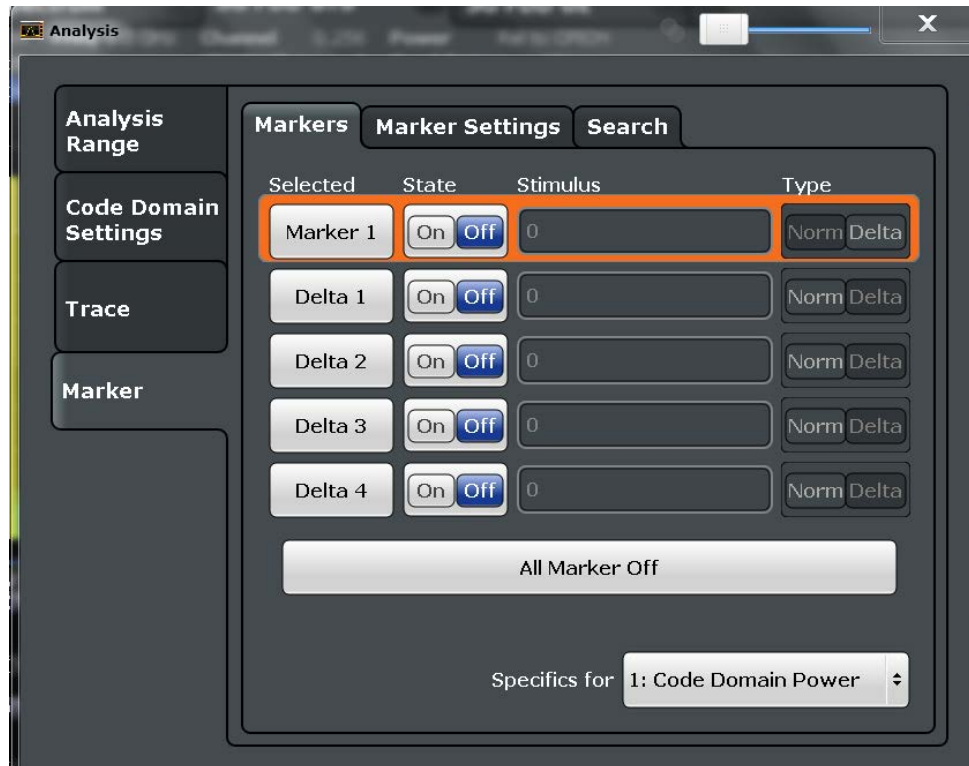
Markers help you analyze your measurement results by determining particular values in the diagram. Thus you can extract numeric values from a graphical display.

Markers are configured in the "Marker" dialog box which is displayed when you do one of the following:

- In the "Overview", select "Analysis", and switch to the vertical "Marker" tab.
- Press the MKR key, then select the "Marker Config" softkey.
- [Individual Marker Settings](#).....189
- [Marker Search Settings](#).....191
- [Marker Positioning Functions](#).....193

### 6.3.1 Individual Marker Settings

In VSA evaluations, up to 5 markers can be activated in each diagram at any time.



Selected Marker.....	190
Marker State.....	190
Stimulus.....	190
Marker Type.....	191
Assigning the Marker to a Trace.....	191
All Markers Off.....	191
Couple Windows.....	191

### Selected Marker

Marker name. The marker which is currently selected for editing is highlighted orange.

SCPI command:

Marker selected via suffix <m> in remote commands.

### Marker State

Activates or deactivates the marker in the diagram.

SCPI command:

[CALCulate<n>:MARKer<m>\[:STATe\]](#) on page 335

[CALCulate<n>:DELTAmarker<m>\[:STATe\]](#) on page 336

### Stimulus

Defines the position of the marker on the x-axis.

SCPI command:

[CALCulate<n>:DELTAmarker<m>:X](#) on page 336

[CALCulate<n>:MARKer<m>:X](#) on page 335

**Marker Type**

Toggles the marker type.

The type for marker 1 is always "Normal", the type for delta marker 1 is always "Delta". These types cannot be changed.

**Note:** If normal marker 1 is the active marker, switching the "Mkr Type" activates an additional delta marker 1. For any other marker, switching the marker type does not activate an additional marker, it only switches the type of the selected marker.

"Normal"            A normal marker indicates the absolute value at the defined position in the diagram.

"Delta"            A delta marker defines the value of the marker relative to the specified reference marker (marker 1 by default).

SCPI command:

[CALCulate<n>:MARKer<m>\[:STATe\]](#) on page 335

[CALCulate<n>:DELTAmarker<m>\[:STATe\]](#) on page 336

**Assigning the Marker to a Trace**

The "Trace" setting assigns the selected marker to an active trace. The trace determines which value the marker shows at the marker position. If the marker was previously assigned to a different trace, the marker remains on the previous frequency or time, but indicates the value of the new trace.

The marker can also be assigned to the currently active trace using the "Marker to Trace" softkey.

If a trace is turned off, the assigned markers and marker functions are also deactivated.

SCPI command:

[CALCulate<n>:MARKer<m>:TRACe](#) on page 335

**All Markers Off**

Deactivates all markers in one step.

SCPI command:

[CALCulate<n>:MARKer<m>:AOFF](#) on page 334

**Couple Windows**

If enabled, markers in all diagrams with the same x-axis (time or symbols) have coupled x-values (except for capture buffer display), i.e. if you move the marker in one diagram, it is moved in all coupled diagrams.

SCPI command:

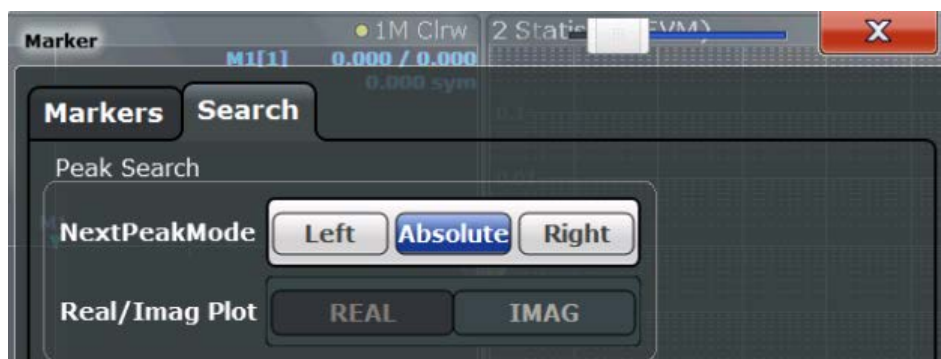
[CALCulate<n>:MARKer<m>:LINK](#) on page 334

**6.3.2 Marker Search Settings**

Several functions are available to set the marker to a specific position very quickly and easily. In order to determine the required marker position, searches may be performed. The search results can be influenced by special settings.

These settings are available as softkeys in the "Marker To" menu, or in the "Search" tab of the "Marker" dialog box. To display this tab, do one of the following:

- Press the MKR key, then select the "Marker Config" softkey. Then select the horizontal "Search" tab.
- In the "Overview", select "Analysis", and switch to the vertical "Marker Config" tab. Then select the horizontal "Search" tab.



Search Mode for Next Peak.....	192
Real / Imag Plot.....	192
Search Limits (Left / Right).....	193

### Search Mode for Next Peak

Selects the search mode for the next peak search.

- "Left"                Determines the next maximum/minimum to the left of the current peak.
- "Absolute"            Determines the next maximum/minimum to either side of the current peak.
- "Right"                Determines the next maximum/minimum to the right of the current peak.

SCPI command:

`CALCulate<n>:DELTaMarker<m>:MAXimum:LEFT` on page 337

`CALCulate<n>:MARKer<m>:MAXimum:LEFT` on page 339

`CALCulate<n>:DELTaMarker<m>:MAXimum:NEXT` on page 338

`CALCulate<n>:MARKer<m>:MAXimum:NEXT` on page 339

`CALCulate<n>:DELTaMarker<m>:MAXimum:RIGHT` on page 338

`CALCulate<n>:MARKer<m>:MAXimum:RIGHT` on page 339

`CALCulate<n>:DELTaMarker<m>:MINimum:LEFT` on page 338

`CALCulate<n>:MARKer<m>:MINimum:LEFT` on page 340

`CALCulate<n>:DELTaMarker<m>:MINimum:NEXT` on page 338

`CALCulate<n>:MARKer<m>:MINimum:NEXT` on page 340

`CALCulate<n>:DELTaMarker<m>:MINimum:RIGHT` on page 339

`CALCulate<n>:MARKer<m>:MINimum:RIGHT` on page 340

### Real / Imag Plot

Defines whether marker search functions are performed on the real or imaginary trace of the "Real/Imag" measurement.

SCPI command:

`CALCulate<n>:MARKer:SEARch` on page 341



**Search Limits (Left / Right)**

If activated, limit lines are defined and displayed for the search. Only results within the limited search range are considered.

SCPI command:

[CALCulate:MARKer:X:SLIMits\[:STATE\]](#) on page 342

[CALCulate:MARKer:X:SLIMits:LEFT](#) on page 341

[CALCulate:MARKer:X:SLIMits:RIGHT](#) on page 341

**6.3.3 Marker Positioning Functions**

The following functions set the currently selected marker to the result of a peak search. These functions are available as softkeys in the "Marker To" menu, which is displayed when you press the MKR -> key.

<a href="#">Peak Search</a> .....	193
<a href="#">Search Next Peak</a> .....	193
<a href="#">Max  Peak </a> .....	193
<a href="#">Search Minimum</a> .....	193
<a href="#">Search Next Minimum</a> .....	194

**Peak Search**

Sets the selected marker/delta marker to the maximum of the trace. If no marker is active, marker 1 is activated.

SCPI command:

[CALCulate<n>:MARKer<m>:MAXimum\[:PEAK\]](#) on page 340

[CALCulate<n>:DELTamarker<m>:MAXimum\[:PEAK\]](#) on page 338

**Search Next Peak**

Sets the selected marker/delta marker to the next (lower) maximum of the assigned trace. If no marker is active, marker 1 is activated.

SCPI command:

[CALCulate<n>:MARKer<m>:MAXimum:NEXT](#) on page 339

[CALCulate<n>:DELTamarker<m>:MAXimum:NEXT](#) on page 338

**Max |Peak|**

Sets the active marker/delta marker to the largest absolute peak value (maximum or minimum) of the selected trace.

SCPI command:

[CALCulate<n>:MARKer<m>:MAXimum:APEak](#) on page 339

**Search Minimum**

Sets the selected marker/delta marker to the minimum of the trace. If no marker is active, marker 1 is activated.

SCPI command:

[CALCulate<n>:MARKer<m>:MINimum\[:PEAK\]](#) on page 340

[CALCulate<n>:DELTamarker<m>:MINimum\[:PEAK\]](#) on page 339

**Search Next Minimum**

Sets the selected marker/delta marker to the next (higher) minimum of the selected trace. If no marker is active, marker 1 is activated.

SCPI command:

[CALCulate<n>:MARKer<m>:MINimum:NEXT](#) on page 340

[CALCulate<n>:DELTAmarker<m>:MINimum:NEXT](#) on page 338

## 6.4 Modulation Accuracy Limit Lines

The results of a modulation accuracy measurement can be checked for violation of defined limits automatically (see "[Modulation Accuracy](#)" on page 18).

Limits and the limit check are configured in the "Limits" dialog box that is displayed when you press the "ModAcc Limits Config" softkey in the "Lines" menu.

	Limit Value	Check
EVM RMS	1.5 %	<input type="checkbox"/>
EVM Peak	2.5 %	<input type="checkbox"/>
Phase Error RMS	1.5 °	<input type="checkbox"/>
Phase Error Peak	3.5 °	<input type="checkbox"/>
Magnitude Error RMS	1.5 %	<input type="checkbox"/>
Magnitude Error Peak	2.5 %	<input type="checkbox"/>
Carrier Frequency Error	1.0 kHz	<input type="checkbox"/>
Rho	0.999	<input type="checkbox"/>
I/Q Offset	-40.0 dB	<input type="checkbox"/>

Note: Limits for Current and Peak are always equal!

For details on working with limits see [chapter 7.3.2, "How to Check Limits for Modulation Accuracy"](#), on page 216.

Checking Modulation Accuracy Limits.....	195
Set to Default.....	195
Current/Mean/Peak.....	195
L Limit Value.....	195
L Check.....	196

### Checking Modulation Accuracy Limits

Activates or deactivates evaluation of modulation accuracy limits in the result summary.

SCPI command:

[CALCulate:LIMit:MACCuracy:STATe](#) on page 342

### Set to Default

Restores the default limits and deactivates all checks.

SCPI command:

[CALCulate:LIMit:MACCuracy:DEFault](#) on page 342

### Current/Mean/Peak

Defines and activates the limits for the currently measured value, the mean and the peak value on separate tabs. Note that the limits for the current and peak values are always the same.

### Limit Value ← Current/Mean/Peak

Define the limit with which the currently measured, mean or peak value is to be compared. A different limit value can be defined for each result type. Depending on the modulation type, different result types are available.

Result type	Remote command
<b>PSK, MSK, QAM:</b>	
EVM RMS	<a href="#">CALCulate&lt;n&gt;:LIMit:MACCuracy:EVM:RCURrent:VALue</a> on page 345
EVM Peak	<a href="#">CALCulate&lt;n&gt;:LIMit:MACCuracy:EVM:PCURrent:VALue</a> on page 345
Phase Err Rms	<a href="#">CALCulate&lt;n&gt;:LIMit:MACCuracy:PERRor:RCURrent:VALue</a> on page 346
Phase Err Peak	<a href="#">CALCulate&lt;n&gt;:LIMit:MACCuracy:PERRor:PCURrent:VALue</a> on page 346
Magnitude Err Rms	<a href="#">CALCulate&lt;n&gt;:LIMit:MACCuracy:MERRor:RCURrent:VALue</a> on page 346
Magnitude Err Peak	<a href="#">CALCulate&lt;n&gt;:LIMit:MACCuracy:MERRor:PCURrent:VALue</a> on page 346
Carr Freq Err	<a href="#">CALCulate&lt;n&gt;:LIMit:MACCuracy:CFERror:CURRent:VALue</a> on page 344
Rho	<a href="#">CALCulate&lt;n&gt;:LIMit:MACCuracy:RHO:CURRent:VALue</a> on page 347

Result type	Remote command
IQ Offset	<code>CALCulate&lt;n&gt;:LIMit:MACCuracy:OOFset:CURRent:VALue</code> on page 346
<b>FSK modulation only:</b>	
Freq Err Rms	<code>CALCulate&lt;n&gt;:LIMit:MACCuracy:FERRor:RCURrent:VALue</code> on page 345
Freq Err Peak	<code>CALCulate&lt;n&gt;:LIMit:MACCuracy:FERRor:PCURrent:VALue</code> on page 345
Magnitude Err Rms	<code>CALCulate&lt;n&gt;:LIMit:MACCuracy:MERRor:RCURrent:VALue</code> on page 346
Magnitude Err Peak	<code>CALCulate&lt;n&gt;:LIMit:MACCuracy:MERRor:PCURrent:VALue</code> on page 346
FSK Dev Err	<code>CALCulate&lt;n&gt;:LIMit:MACCuracy:FERRor:PCURrent:VALue</code> on page 345
Carr Freq Err	<code>CALCulate&lt;n&gt;:LIMit:MACCuracy:CFERRor:CURRent:VALue</code> on page 344

**Check ← Current/Mean/Peak**

Considers the defined limit value in the limit check, if checking is activated.

SCPI command:

`CALCulate<n>:LIMit:MACCuracy:<ResultType>:<LimitType>:STATe`  
on page 343

## 6.5 Display and Window Configuration

The captured I/Q data can be evaluated using various different methods without having to start a new measurement.

As opposed to the R&S FSW Spectrum application or other applications, in VSA configuring the result display requires two steps:

1. **Display Configuration:** In the first step, you select the data source for the evaluation and the window placement in the SmartGrid.  
The SmartGrid mode is activated automatically when you select the "Display Config" softkey from the main VSA menu or the "Display Config" button in the Overview. Note, however, that this button is only displayed in the general Overview, not for window-specific configuration ("Specifics for" must be disabled).  
The default evaluation for the selected data source is displayed in the window. Up to 16 result displays can be displayed simultaneously in separate windows. The VSA evaluation methods are described in [chapter 3, "Measurements and Result Displays"](#), on page 15.  
For details on working with the SmartGrid see the R&S FSW Getting Started manual.

2. **Window Configuration:** In a second step, you can select a different evaluation method (result type) for the window, based on the data source selected in the "Display Configuration".

### 6.5.1 Window Configuration

For each window you can select a different evaluation method (result type), based on the data source selected in the "Display Configuration". Further window settings are available for some result types.

The "Window Configuration" is displayed when you select the "Window Config" softkey from the main VSA menu.



Some settings are only displayed after you select the "More" button in the dialog box. To hide these settings, select the "Less" button.

Signal Source.....	197
Result Type.....	197
Result Type Transformation.....	197
Highlight Symbols.....	198
Display Points/Sym.....	198
Oversampling.....	198

#### Signal Source

Data source as selected in the "Display Configuration" (see [chapter 3, "Measurements and Result Displays"](#), on page 15). If you change the signal source setting here, the default result type for the new data source is activated for the current window.

SCPI command:

`LAYout:ADD[:WINDow]?` on page 351

#### Result Type

The result type defines the evaluation method used in the current window.

The available result types in VSA are described in [chapter 3.2, "Result Types in VSA"](#), on page 19.

SCPI command:

`CALCulate<n>:FORMat` on page 357

#### Result Type Transformation

For certain result types it is not only possible to see the common "over time" representation of the measurement, but also the spectrum or the statistics (in form of a histogram). These are the transformations of the results.

These settings are not available for symbol evaluation, i.e. the following signal sources:

- Symbols
- Modulation Accuracy

"Normal"                      Evaluation in time domain  
    X-axis displays time values.

"Spectrum"	Evaluation in frequency domain X-axis displays frequency values. The usable I/Q bandwidth is indicated in the display.
"Statistics"	Statistical evaluation (histogram) X-axis displays former y-values. Y-axis displays statistical information: <ul style="list-style-type: none"> <li>• Trace 1: the probability of occurrence of a certain value is plotted against the value</li> <li>• Trace 2: the cumulated probability of occurrence is plotted against the value.</li> </ul>

SCPI command:

[CALCulate<n>:DDEM:SPECTrum\[:STATe\]](#) on page 357

[CALCulate<n>:STATistics:CCDF\[:STATe\]](#) on page 358

### Highlight Symbols

If enabled, the symbol instants are highlighted as squares in the window for measured and reference signals in time (normal) display, as well as error displays.

Only evaluations that are based on symbols (e.g. constellations or traces) support this function.

SCPI command:

[DISPlay\[:WINDow<n>\]:TRACe:SYMBOL](#) on page 360

### Display Points/Sym

Defines the number of display points that are displayed per symbol. If more points per symbol are selected than the defined [Sample Rate](#), the additional points are interpolated for the display. The more points are displayed per symbol, the more detailed the trace becomes.

For more information see [chapter 4.7, "Display Points vs Estimation Points per Symbol"](#), on page 115

**Note:** If the capture buffer is used as the signal source, the [Sample Rate](#) defines the number of displayed points per symbol; the "Display Points/Sym" parameter is not available.

If "Auto" is enabled, the [Sample Rate](#) value is used.

Alternatively, select the number of points to be displayed per symbol manually. The available values depend on the source type.

"1" only the symbol time instants are displayed

"2, 4, 8, 16, 32" more points are displayed than symbols

"Capture Over-sampling" the number of samples per symbol defined in the signal capture settings are displayed (see "[Sample Rate](#)" on page 153)

SCPI command:

[DISPlay\[:WINDow<n>\]:PRATe\[:VALue\]](#) on page 359

[DISPlay\[:WINDow<n>\]:PRATe:AUTO](#) on page 359

### Oversampling

Defines the sample basis for statistical evaluation. This setting is only available for the result type transformation "Statistics".

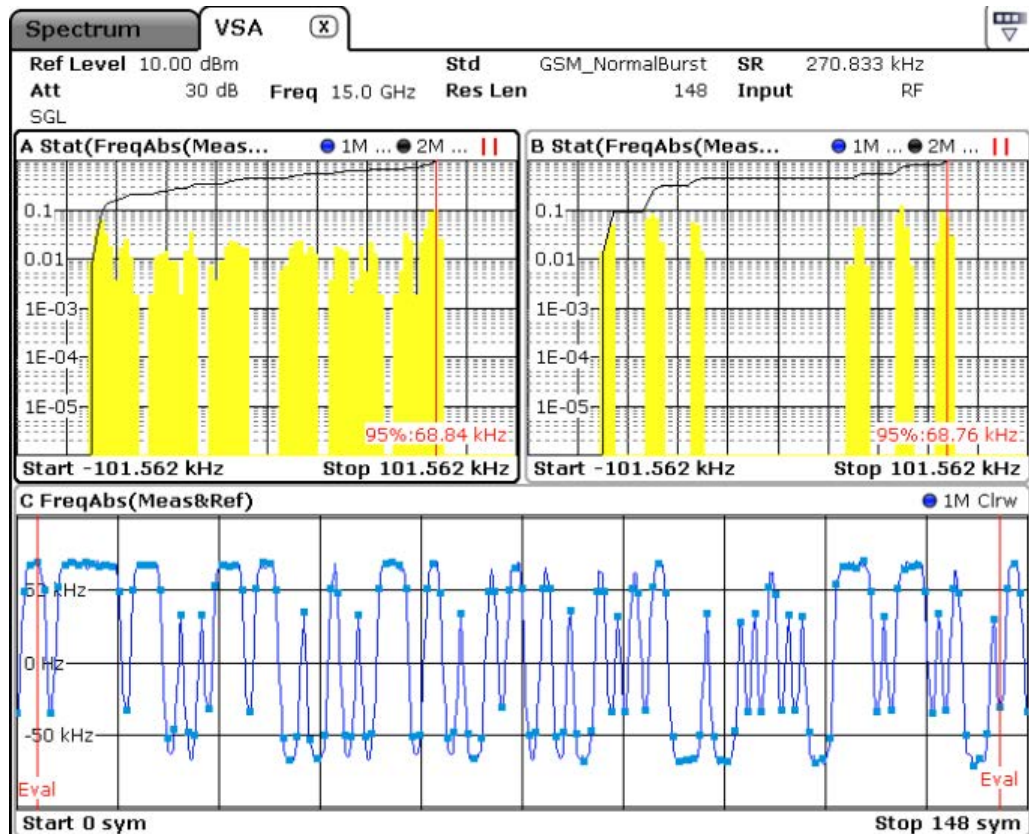


Fig. 6-1: Statistics measurement: window C: measured signal (symbols highlighted); window A: statistics for all trace points; window B: statistics for symbol instants only

- "Symbols only" Statistics are calculated for symbol instants only  
See window B in [figure 6-1](#).
- "Infinite" Statistics are calculated for all trace points (symbol instants and intermediate times)  
See window A in [figure 6-1](#).
- "auto" currently not used

SCPI command:

[CALCulate<n>:STATistics:MODE](#) on page 359

## 6.6 Zoom Functions

The zoom functions are only available from the toolbar.

<a href="#">Single Zoom</a> .....	200
<a href="#">Multiple Zoom</a> .....	200
<a href="#">Restore Original Display</a> .....	200
<a href="#">Deactivating Zoom (Selection mode)</a> .....	200

### Single Zoom



A single zoom replaces the current diagram by a new diagram which displays an enlarged extract of the trace. This function can be used repetitively until the required details are visible.

SCPI command:

[DISPlay\[:WINDow<n>\]:ZOOM:STATe](#) on page 348

[DISPlay\[:WINDow<n>\]:ZOOM:AREA](#) on page 347

### Multiple Zoom



In multiple zoom mode, you can enlarge several different areas of the trace simultaneously. An overview window indicates the zoom areas in the original trace, while the zoomed trace areas are displayed in individual windows. The zoom area that corresponds to the individual zoom display is indicated in the lower right corner, between the scrollbars.

SCPI command:

[DISPlay\[:WINDow<n>\]:ZOOM:MULTiple<zoom>:STATe](#) on page 349

[DISPlay\[:WINDow<n>\]:ZOOM:MULTiple<zoom>:AREA](#) on page 348

### Restore Original Display



Restores the original display and closes all zoom windows.

SCPI command:

[DISPlay\[:WINDow<n>\]:ZOOM:STATe](#) on page 348 (single zoom)

[DISPlay\[:WINDow<n>\]:ZOOM:MULTiple<zoom>:STATe](#) on page 349 (for each multiple zoom window)

### Deactivating Zoom (Selection mode)



Deactivates zoom mode; tapping the screen no longer invokes a zoom, but selects an object.

SCPI command:

[DISPlay\[:WINDow<n>\]:ZOOM:STATe](#) on page 348 (single zoom)

[DISPlay\[:WINDow<n>\]:ZOOM:MULTiple<zoom>:STATe](#) on page 349 (for each multiple zoom window)



## 7 How to Perform Vector Signal Analysis

Using the VSA option you can perform vector signal analysis measurements using pre-defined standard setting files, or independently of digital standards using user-defined measurement settings. Such settings can be stored for recurrent use.

Thus, configuring VSA measurements requires one of the following tasks:

- Selecting an existing standard settings file and, if necessary, adapting the measurement settings to your specific requirements.
- Configuring the measurement settings and, if necessary, storing the settings in a file.
- [How to Perform VSA According to Digital Standards](#).....201
- [How to Perform Customized VSA Measurements](#).....203
- [How to Analyze the Measured Data](#).....212

### 7.1 How to Perform VSA According to Digital Standards

In order to perform vector signal analysis as specified in digital standards, various pre-defined settings files for common digital standards are provided for use with the VSA option. In addition, you can create your own settings files for user-specific measurements.

For an overview of predefined standards and settings see [chapter A.1, "Predefined Standards and Settings"](#), on page 398.

This section provides instructions for the following tasks:

- ["To perform a measurement according to a standard"](#) on page 201
- ["To load predefined settings files"](#) on page 202
- ["To store settings as a standard file"](#) on page 202
- ["To delete standard files"](#) on page 202
- ["To restore standard files"](#) on page 202

#### To perform a measurement according to a standard

1. Press the MODE key on the front panel and select the "VSA" application.
2. Press the MEAS key and select the "Digital Standards" softkey.
3. Select the required settings file and then "Load" (see ["To load predefined settings files"](#) on page 202).

The instrument is adjusted to the stored settings for the selected standard and a measurement is started immediately.

4. Press the RUN SINGLE key to stop the continuous measurement mode and start a defined number of measurements.

The measured data is stored in the capture buffer and can be analyzed (see [chapter 7.3, "How to Analyze the Measured Data"](#), on page 212).

**To load predefined settings files**

1. In the "Meas" menu, select the "Digital Standards" softkey.
2. In the file selection dialog box, select the standard whose settings you want to load. To change the path, press the arrow icons at the right end of the "Path" field and select the required folder from the file system.
3. Press the "Load" button.

The dialog box is closed and the instrument is adjusted to the stored settings for the selected standard.

**To store settings as a standard file**

1. Configure the measurement as required (see [chapter 7.2, "How to Perform Customized VSA Measurements"](#), on page 203).
2. In the "Meas" menu, select the "Digital Standards" softkey.
3. In the "File Name" field, enter the name of the standard for which you want to store settings. To change the path, press the arrow icons at the right end of the "Path" field and select the required folder from the file system. To insert a new folder, select the "New Folder" button and enter a name in the "New Folder" dialog box.
4. Press the "Save" button.

The dialog box is closed and the current measurement settings are stored in a standard file.

**To delete standard files**

1. In the "Meas" menu, select the "Digital Standards" softkey.
2. In the "Manage VSA Standards" file selection dialog box, select the standard whose settings file you want to delete. Standards predefined by Rohde & Schwarz can also be deleted. To change the path, press the arrow icons at the right end of the "Path" field and select the required folder from the file system.
3. Press the "Delete" button.
4. Confirm the message to avoid unintentionally deleting a standard.

The standard file is removed from the folder.

**To restore standard files**

1. To restore the predefined standard files, do one of the following:
  - In the "Meas" menu, select the "Digital Standards" softkey. The "Manage VSA Standards" file selection dialog box is displayed.
  - In the "Meas" menu, select the "Restore Factory Settings" softkey.

2. Select "Restore Standard Files".

The standards predefined by Rohde & Schwarz available at the time of delivery are restored to the `Standards` folder.

## 7.2 How to Perform Customized VSA Measurements

In addition to performing vector signal analysis strictly according to specific digital standards, you can configure the analysis settings for customized tasks. The general process for a typical VSA measurement is described here.

1. Press the MODE key on the front panel and select the "VSA" application.
2. Select the "Overview" softkey to display the "Overview" for VSA.
3. Select the "Signal Description" button and configure the expected signal characteristics.  
If the input data is largely known in advance, define files with the known data to compare the measured data to (see [chapter 7.2.3, "How to Manage Known Data Files"](#), on page 208). This can improve demodulation significantly.
4. Select the "Input/Frontend" button to define the input signal's center frequency, amplitude and other basic settings.
5. Select the "Signal Capture" button and define how much and which data to capture: (In MSRA mode, define the application data instead, see [chapter 4.9, "VSA in MSRA Operating Mode"](#), on page 118).
  - "Capture length": the duration or number of symbols to be captured
  - "Sample rate": how many points are to be captured for each symbol
6. Optionally, select the "Trigger" tab and define a trigger for data acquisition, for example an external trigger to start capturing data only when a useful signal is transmitted. (In MSRA mode, define a "Capture Offset" instead, see [chapter 4.9, "VSA in MSRA Operating Mode"](#), on page 118).
7. For bursted signals, select the "Burst/Pattern" button and define the criteria to detect the individual bursts within the input signal (see [chapter 7.2.2, "How to Perform Pattern Searches"](#), on page 204).
8. Select the "Cut Result Ranges" button and define which of the captured data is to be demodulated (see [chapter 7.2.4, "How to Define the Result Range"](#), on page 211).
9. Select the "Demodulation" button to configure and optimize the synchronization process.
10. Select the "Meas filter" button to select a different or user-defined measurement filter to improve the accuracy of the error vector (see [chapter 7.2.1, "How to Select User-Defined Filters"](#), on page 204).

11. Select the "Evaluation Range" button to define which part of the demodulated data is to be evaluated and displayed.
12. Press the RUN SINGLE key to stop the continuous sweep and start a new sweep with the new configuration.

The measured data is stored in the capture buffer and can be analyzed (see [chapter 7.3, "How to Analyze the Measured Data"](#), on page 212)

### 7.2.1 How to Select User-Defined Filters

The most frequently required measurement and TX filters required for vector signal analysis according to digital standards are provided by the R&S FSW VSA application. However, you can also load user-defined filters.

#### To load a user measurement filter

1. In the "Overview", select the "Meas Filter" button.
2. In the "Meas Filter" tab of the "Demodulation & Measurement Filter" dialog box, select "Type": *User*.
3. Select "Load User Filter".
4. Load your `.vaf` file from the USB stick.

#### To load a user transmit (TX) filter

1. In the "Overview", select the "Signal Description" button.
2. In the "Modulation" tab of the "Signal Description" dialog box, select "Transmit Filter Type": *User*.
3. Select "Load User Filter".
4. Load your `.vaf` file from the USB stick.

### 7.2.2 How to Perform Pattern Searches

#### To configure a pattern search

1. In the "Overview", select "Signal Description".
2. Select the "Signal Structure" tab.
3. Select the "Burst Signal" signal type.
4. Enable the "Pattern" option.
5. From the "Name" selection list, select a pattern that is assigned to the currently defined standard.

6. If the pattern you require is not available, continue with ["To add a predefined pattern to a standard"](#) on page 205 or [chapter 7.2.2.2, "How to Define a New Pattern"](#), on page 206.
7. Optionally, select the "Offset" option and enter the number of symbols in the signal to be ignored during the pattern search.
8. Close the "Signal Description" dialog box.
9. In the "Overview" dialog box, select "Burst / Pattern " and switch to the "Pattern Search" tab.
10. Select "On" to enable the search.  
To enable a search only if a pattern is part of the signal description, enable the "Auto" option.  
  
The results of the pattern search with the selected pattern on the current measurement data is displayed in the "Preview" area of the dialog box. Whether a pattern was detected or not is indicated in the "Information" area.
11. If necessary, adapt the I/Q correlation threshold. If bursts are not detected, reduce the threshold; if false bursts are detected, increase the threshold.
12. Optionally, enable the "Meas only if pattern symbols correct" option. In this case, measurement results are only displayed if a valid pattern has been detected.
13. Close the dialog box.  
  
The selected pattern is used for a pattern search in the next measurement.

### 7.2.2.1 How To Assign Patterns to a Standard

Only patterns that are assigned to the currently selected VSA standard are available for the pattern search.

#### To add a predefined pattern to a standard

1. In the "Overview", select "Signal Description" and switch to the "Signal Structure" tab.
2. Select "Pattern Config" to display the "Advanced Pattern Settings" dialog box.
3. In the list of "All Patterns", select the required pattern.  
If the required pattern is not displayed, see ["To change the display for the list of patterns"](#) on page 207.
4. Select "Add to Standard".  
The selected pattern is inserted in the list of "Standard Patterns".
5. Select the pattern to be used for the pattern search from the list of "Standard Patterns".

#### To remove a predefined pattern from a standard

1. In the "Overview", select "Signal Description" and switch to the "Signal Structure" tab.

2. Select "Pattern Config" to display the "Advanced Pattern Settings" dialog box.
3. Select the pattern from the list of "Standard Patterns".
4. Select "Remove from Standard".

The pattern is removed from the list of "Standard Patterns" and is no longer assigned to the current standard, but is still available for assignment from the list of "All Patterns".

### 7.2.2.2 How to Define a New Pattern

1. In the "Overview", select "Signal Description" and switch to the "Signal Structure" tab.
2. Select "Pattern Config" to display the "Advanced Pattern Settings" dialog box.
3. Select the "New" button.

The pattern definition dialog box is displayed.

4. Define the following pattern settings:

Setting	Description
Name	Pattern name that will be displayed in selection list
Description	Optional description of the pattern which is displayed in the pattern details
Modulation order	Number of values each symbol can represent, e.g. 8 for 8-PSK
Comment	Optional comment for the pattern, displayed in the pattern details (kept for compatibility with FSQ)

5. Define the format used to define the individual symbols of the pattern.
6. Define the symbols of the pattern.
  - a) Select the symbol field you want to define.  
If necessary, add a new symbol field by selecting "Add".
  - b) Enter a value using the keyboard. Depending on the "Modulation Order"  $\langle n \rangle$ , the value can be in the range 0 to  $\langle n \rangle - 1$ .
  - c) Select the next symbol field, or insert a new one, and continue to define the other symbols. To scroll through the fields for long patterns, use the scrollbar beneath the input area. The number beneath the scrollbar at the right end indicates the sequential number of the last symbol field, the number in the center indicates the sequential number of the currently selected symbol field.  
To remove a symbol field, select it and press "Remove".
7. Select "Save" to save the pattern under the specified name. The pattern is stored on the instrument as an xml file named  $\langle \text{Name} \rangle . \text{xml}$  under  $\langle \text{Installation directory} \rangle \backslash \text{vsa} \backslash \text{Pattern}$ .



If you copy this file to another location, you can restore the pattern at a later time, e.g. after deletion.

**Example: Defining a pattern**

**New Pattern**

Name: TETRA\_SA

Description: Special Continuous Downlink Burst

Mod. Order: 4

Symbols

Format:  Binary  Hex  Decimal

A B C D E F

Size: 11

3	1	0	0	3	2	2	1
3	1	1					

Add

Remove

1 12 16

Comment

Save Cancel

*Fig. 7-1: Pattern definition***7.2.2.3 How to Manage Patterns****To change the display for the list of patterns**

1. In the "Overview", select "Signal Description" and switch to the "Signal Structure" tab.
2. Select "Pattern Config" to display the "Advanced Pattern Settings" dialog box.
3. To display all available patterns, select "Show All".  
To display all patterns that are compatible to the defined standard, select "Show Compatible".  
To display only patterns that contain a specific prefix, enter the "Prefix" in the edit field.

**To edit a predefined pattern**

1. In the "Overview", select "Signal Description" and switch to the "Signal Structure" tab.
2. Select "Pattern Config" to display the "Advanced Pattern Settings" dialog box.
3. Select the pattern from the list of "All Patterns".

4. Press "Edit Pattern".
5. Change the settings as required as described in [chapter 7.2.2.2, "How to Define a New Pattern"](#), on page 206.

#### To delete a predefined pattern

1. In the "Overview", select "Signal Description" and switch to the "Signal Structure" tab.
2. Select "Pattern Config" to display the "Advanced Pattern Settings" dialog box.
3. Select the pattern from the list of "All Patterns".
4. Press "Delete Pattern".

The pattern is removed from the lists of available and assigned patterns and can no longer be assigned to any standard. Any existing assignments to other standards are removed, as well.

#### To restore predefined patterns

Default patterns provided by Rohde&Schwarz can be restored.

1. Press the MEAS key.
2. Select the "Restore Factory Settings" softkey.
3. Select the "Restore Pattern Files" softkey.

The patterns as defined by Rohde & Schwarz at the time of delivery are restored.



#### Restoring user-defined patterns

User-defined patterns can only be restored if you have a copy of the pattern file created during creation. In this case, copy the file named `<Patternname>.xml` back to the installation directory of the VSA application under `vsa/standards`. After a preset or after performing certain operations (e.g. changing the modulation settings) the pattern will be included in the list of "All Patterns" again.

---

## 7.2.3 How to Manage Known Data Files

You can load xml files containing the possible sequences to the VSA application and use them to compare the measured data to. In particular, you can use known data for the following functions:

- Fine synchronization during the demodulation process (see [figure 4-43](#) and "[Fine Synchronization](#)" on page 178)
- Calculation of the Bit Error Rate (BER), see [chapter 3.2.23, "Bit Error Rate \(BER\)"](#), on page 42

### 7.2.3.1 How to Load Known Data Files

Known Data files are loaded in the "Modulation & Signal Description" settings.



### To load an existing Known Data file

1. In the "Overview", select "Signal Description".
2. Switch to the "Known Data" tab.
3. Activate the usage of a Known Data file by enabling the "Known Data" option. This enables the "Load Data File" function.
4. Select the "Load Data File" button.  
A file selection dialog box is displayed.
5. Select the xml file which contains the possible data sequences of the input signal.  
The file must comply with the syntax described in [chapter A.4, "Known Data File Syntax Description"](#), on page 408.

The header information of the xml file is displayed in the dialog box.

Once a Known Data file has been loaded, the Bit Error Rate result display becomes available.

If the "Fine Synchronization" setting in the "Demodulation" dialog box is set to "Auto" mode, the known data is also used for synchronization. Otherwise it can be selected manually. Defining a maximum symbol error rate for the known data in reference to the analyzed data avoids using a falsely selected or unsuitable file for synchronization (see also ["If SER ≤"](#) on page 179).

### 7.2.3.2 How to Create Known Data Files

You must create the Known Data files yourself according to the possible data sequences of the input signal. Use any xml editing tool you like, following the rules described in [chapter A.4, "Known Data File Syntax Description"](#), on page 408. Before loading the file to the VSA application, make sure the syntax of your file is valid.



#### Auxiliary tool to create Known Data files

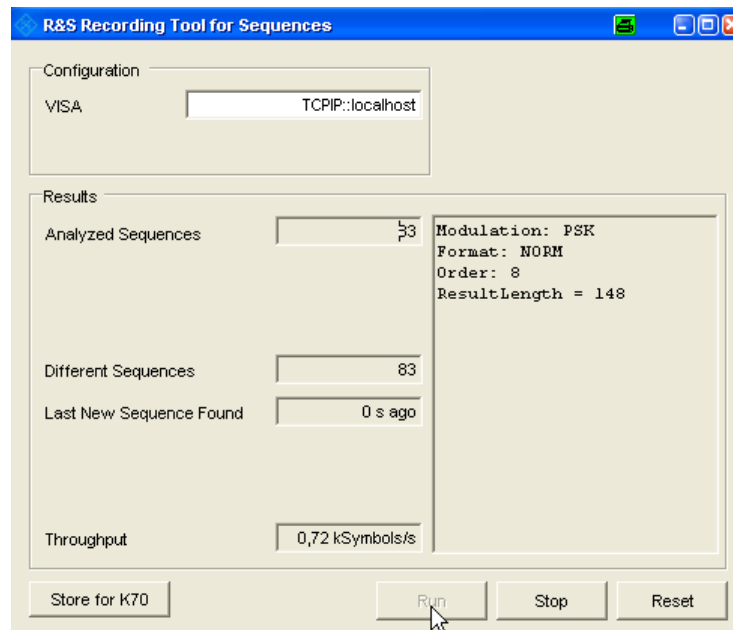
An auxiliary tool to create Known Data files from data that is already available in the VSA application is provided on the instrument free of charge.

---

### To create a Known Data file using the recording tool for sequences

1. Import or apply input data for which stable demodulation results are available to the VSA application. If necessary, adapt the demodulation settings until the requested results are obtained.
2. Execute the file `RecordingToolforSequences.EXE` from the installation directory on the instrument.

The "R&S Recording Tool for Sequences" window is displayed.



3. Start a measurement in the VSA application.
4. In the tool window, select "Run".  
The tool records the demodulated data sequences. The following result information is provided by the tool during recording:
  - **Analyzed Sequences:** number of data sequences analyzed since the tool was started
  - **Different Sequences:** number of unique sequences detected in the measured data
  - **Last New Sequence Found:** time that has passed since the most recent unique sequence was detected
  - **Throughput:** current data processing speed of the tool

Note that while the tool is running, the R&S FSW is set to remote mode, i.e. the manual interface is not available. As soon as the tool is closed, the remote mode is automatically deactivated.
5. When all known possible sequences have been detected, or when a significantly large amount of time has passed so as to assume no more sequences will be detected, stop the tool by selecting "Stop".
6.
  - If the results are acceptable, select "Store for K70" to store a valid xml file with the recorded data sequences on the instrument.  
A file selection dialog box is displayed in which you can select the storage location and file name.  
You can also add an optional comment to the file.
  - Otherwise, reset the tool to start a new recording, possibly after changing the demodulation settings or input data.
7. Close the tool window to return to normal operation of the VSA application.

The created xml file can now be loaded in the VSA application as described in [chapter 7.2.3.1, "How to Load Known Data Files"](#), on page 208.

## 7.2.4 How to Define the Result Range

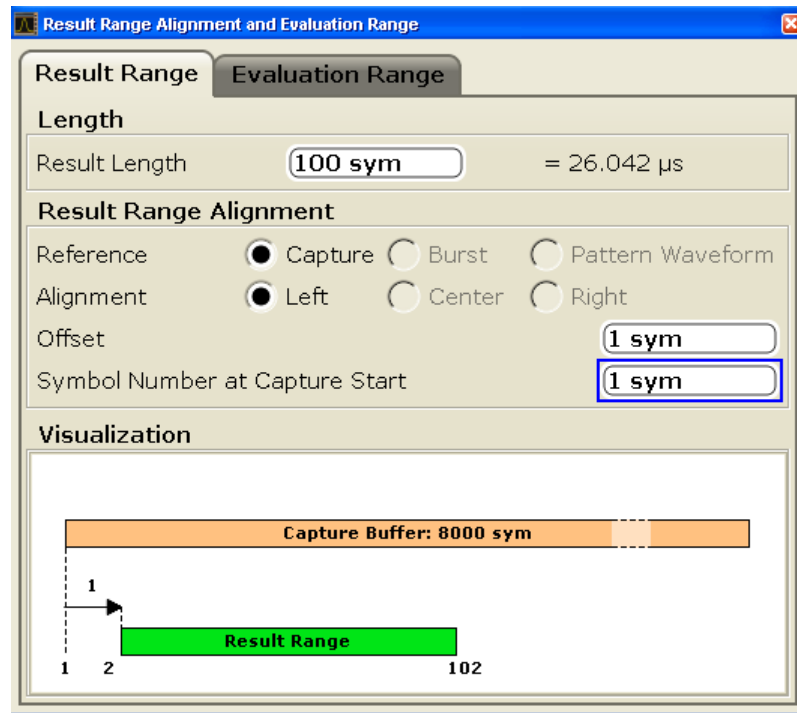
You can define which part of the source signal is analyzed ("Result Range") with reference to the captured data, a detected burst or a detected pattern.

(For details on the functions see [chapter 5.8, "Result Range Configuration"](#), on page 169.)

1. In the "Overview", select "Range Settings".
2. Select the "Result Range" tab.
3. Define the "Result Length", i.e. the number of symbols from the result that are to be analyzed.  
Note that when you use Known Data files as a reference, the "Result Length" specified here must be identical to the length of the specified symbol sequences in the xml file (<ResultLength> element). See [chapter 4.8, "Known Data Files - Dependencies and Restrictions"](#), on page 116.
4. Define the "Reference" for the result range, i.e. the source to which the result will be aligned. The reference can be the captured data, a detected burst or a detected pattern.
5. Define the "Alignment" of the result range to the reference source, i.e. whether the result starts at the beginning of the reference source, ends with the reference source, or is centered with the reference source.
6. Optionally, define an offset of the result range to the reference source, e.g. to ignore the first few symbols of the captured data.
7. Optionally, define the number of the symbol which marks the beginning of the reference source to change the scaling of the x-axis. This offset is added to the one defined for the signal description.

**Example: Defining the result range**

In [figure 7-2](#), a result range will be defined for the first 100 symbols of the capture buffer, starting at the second symbol, which has the symbol number 1 (the capture buffer starts at symbol number 1, the first symbol to be displayed is the second symbol due to the offset:  $1+1=2$ ).



*Fig. 7-2: Example: Defining the Result Range*



The result range is indicated by a green bar along the time axis in capture buffer result displays, see [chapter 4.6, "Measurement Ranges"](#), on page 111.

## 7.3 How to Analyze the Measured Data

Once the data has been stored in the capture buffer, the results can be analyzed in numerous ways. The following tasks are meant to make you familiar with the most common VSA application features. For a description of all analysis functions and settings see [chapter 6, "Analysis"](#), on page 185.

1. Press the MEAS CONFIG key to display the VSA menu.
2. Select the "Display Config" button in the "Overview" or the "Display Config" softkey and select the data sources for evaluation that are of interest to you (see [chapter 6.5, "Display and Window Configuration"](#), on page 196).  
Arrange them on the display to suit your preferences.

For each data source, a window with the default result type for that data source is displayed.

3. Exit the SmartGrid mode.
4. Select the "Window Config" softkey to change the result types and other display settings for the selected window. To change the settings in other windows, select a different window from the "Specifics for" list in the "Window Config" dialog box.
5. Select the "Overview" softkey to display the "Overview".  
Enable the "Specifics for" option to access the analysis functions for the selected window.
6. Select the "Analysis" button in the "Overview" to configure special analysis settings for the individual result displays, for example:
  - Configure markers and delta markers to determine deviations and offsets within the results, e.g. when comparing errors or peaks.
  - Configure the trace to display the average over a series of measurements. If necessary, increase the "Statistics Count" defined in the "Sweep" menu.
7. Press the SWEEP key and select the "Selected Result Rng" softkey to select a specific burst to be evaluated.

The result displays are updated to show the results for the selected burst.

**Tip:** You can use a capture buffer display to navigate through the available result ranges, and analyze the individual result ranges in another window. The currently displayed result range is indicated by a blue bar in the capture buffer display.

8. Optionally, zoom into a diagram to enlarge an area of the displayed data.
9. Optionally, change the display scaling for diagrams (see [chapter 7.3.1, "How to Change the Display Scaling"](#), on page 213).
10. Optionally, check the modulation accuracy against specified limits (see [chapter 7.3.2, "How to Check Limits for Modulation Accuracy"](#), on page 216).
11. Optionally, export the trace data of the measured signal to a file (see [chapter 7.3.3, "How to Export the Trace Data to a File"](#), on page 217).

### 7.3.1 How to Change the Display Scaling

Depending on the type of display (time, spectrum or statistics), various scaling functions are available to adapt the result display to the current data.

#### 7.3.1.1 How to Scale Time and Spectrum Diagrams

The range of the displayed y-axis for time and spectral diagrams can be defined in the following ways:

- manually, by defining the range size, reference values and positions
- automatically, according to the current results

### To define the scaling manually using a reference point

With this method, you define a reference value and a position at which this value is to be displayed on the y-axis.

1. Focus the result window.
2. Select "AMPT > YScale Config > Y-Axis Reference Value".
3. Enter a reference value for the y-axis in the current unit.
4. Select "AMPT > YScale Config > Y-Axis Reference Position" .
5. Enter the position at which this value is to be displayed on the y-axis. The position is a percentage of the entire length, where 100 % refers to the top edge.
6. Select "AMPT > YScale Config > Y-Axis Range".

#### Example:

If you want to analyze errors greater than 95%, you can define the y-axis range as 5 % and position the y-axis to start at 95%. To do so, enter the reference value 95 % and the reference position 0%.

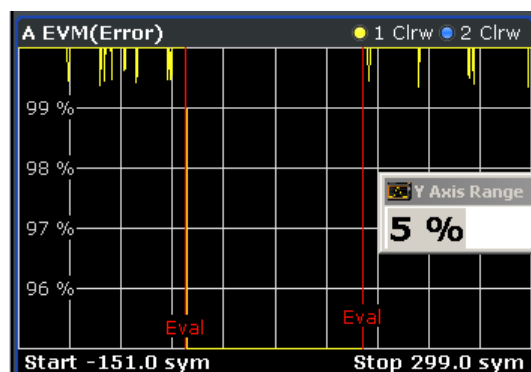


Fig. 7-3: Defining the y-axis scaling using a reference point

### To define the scaling automatically

1. Focus the result window.
2. Select "AMPT > Y-Axis Auto Scale".

The y-axis is adapted to display the current results optimally (only once, not dynamically).

#### 7.3.1.2 How to Scale Statistics Diagrams

Statistic diagrams show the distribution (i.e. probabilities of occurrence) of the values as a set of bars. You can define the number of bars to be displayed, i.e. the granularity of classifications. Additionally, you can specify whether absolute or percentage values are displayed. For statistics measurements, both the x-axis and the y-axis can be scaled to optimize the display.

The range of the displayed x-axis for statistics diagrams can be defined in the following ways:

- manually, by defining reference values and positions
- automatically, according to the current results

The range of the displayed y-axis can be defined in the following ways:

- manually, by defining the minimum and maximum values to be displayed
- automatically, according to the current results

After changing the scaling you can restore the default settings.

#### **To define the number of bars**

1. Focus the result window.
2. Select "AMPT > XScale Config > X-Axis Quantize".
3. Enter the number of bars to be displayed.

The diagram is adapted to display the specified number of bars.

#### **To define the x-axis scaling manually using a reference point and divisions**

With this method, you define a reference value on the x-axis to be displayed at the "Ref Position" of the y-axis. (The reference value is determined internally according to the displayed data and cannot be changed. The beginning of the diagram is at the position 0%, the end is at 100%.) Additionally, you define the range to be displayed in each of the 10 divisions of the display, which determines the total range to be displayed on the x-axis.

1. Focus the result window.
2. Select "AMPT > Scale Config > Reference Value".
3. Enter a reference value on the x axis in the current unit.
4. Define the range to be displayed per division (total range/10).

The x-axis is adapted so that it displays the defined range, with the reference value at the specified position.

**Example:**

If you want to analyze the probabilities of occurrence for errors greater than 95 %, enter the reference value 95 %.

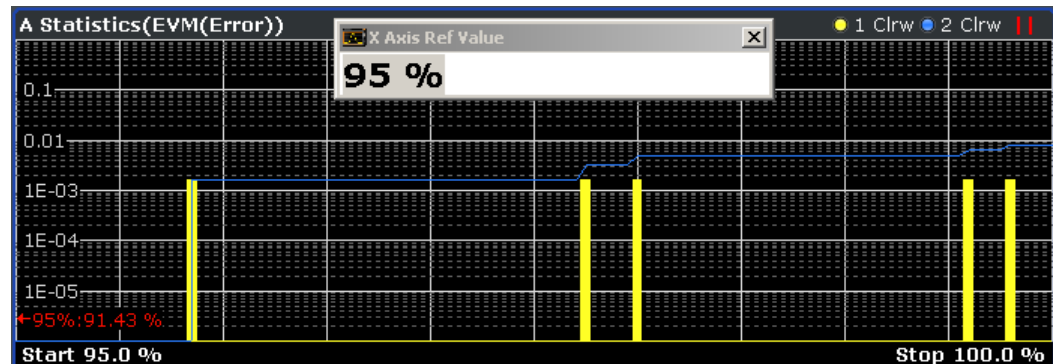


Fig. 7-4: Defining the x-axis scaling using a reference point

**To define the x-axis scaling automatically**

1. Focus the result window.
2. Select "AMPT > XScale Config > Auto Scale".

The x-axis is adapted to display the current results optimally (only once, not dynamically).

**To define the y-axis range manually**

With this method, you define the upper and lower limits of the displayed probability range. Values on the y-axis are normalized which means that the maximum value is 1.0. If the y-axis has logarithmic scale, the distance between max and min value must be at least one decade.

1. Focus the result window.
2. Select "AMPT > YScale Config > Y-Axis Min Value".
3. Enter the lower limit in the current unit.
4. Select "AMPT > YScale Config > Y-Axis Max Value".
5. Enter the upper limit in the current unit.

The y-axis is adapted to display the specified range. Probabilities of occurrence located outside the display area are applied to the bars at the left or right borders of the display.

**7.3.2 How to Check Limits for Modulation Accuracy**

The results of a modulation accuracy measurement can be checked for violation of defined limits automatically. If limit check is activated and the measured values exceed the limits, those values are indicated in red in the result summary table. If limit check is activated and no values exceed the limits, the checked values are indicated in green.



B Result Summary		Current	Mean	Peak	StdDev	95%ile	Unit
*EVM	RMS	100.00*	100.00	100.00	0.00	100.00	%
	Peak	100.00	100.00	100.00	0.00	100.00	%
Phase Error	RMS	0.00	0.00	0.00	0.00	0.00	deg
	Peak	0.00	0.00	0.00	0.00	0.00	deg
Carrier Frequency Error		-0.00	-0.00	-0.00	0.00	-0.00	Hz
Rho		1.000 000	1.000 000	1.000 000	0.000 000	1.000 000	
IQ Offset		---	---	---	---	---	dB
Gain Imbalance		0.00	0.00	0.00	-193.01	0.00	dB
Quadrature Error		0.00	0.00	0.00	0.00	0.00	deg
Amplitude Droop		0.000 000	0.000 000	0.000 000	-193.010300	0.000 000	dB/sym
Power		-200.00	-200.00	-200.00	-200.00	-200.00	dBm

For details on the limit check functions and settings see [chapter 6.4, "Modulation Accuracy Limit Lines"](#), on page 194.

#### To define a limit check

1. Configure a measurement with "Modulation Accuracy" as the "Source" (see [chapter 6.5, "Display and Window Configuration"](#), on page 196).
2. Press the LINES key on the front panel.
3. Press the "ModAcc Limits Config" softkey in the "Limits" menu.
4. In the "Current" tab, define limits that the current value should not exceed for any or all of the result types.  
Note: the limits for the current value are automatically also defined for the peak value and vice versa. However, the limit check can be enabled individually for current or peak values.
5. Enable the "Check" option for each result type to be included in the limit check.
6. If necessary, define limits and enable the limit check for the mean values of the different result types on the "Mean" tab.
7. If necessary, enable the limit check for the peak values of the different result types on the "Peak" tab.
8. To reset the limits to their default values, press "Set to Default".
9. Enable the "Limit Checking On" option, or press the "ModAcc Limits On" softkey in the "Limits" menu.

The limit check is performed immediately on the current modulation accuracy measurement results and for all subsequent measurements until it is disabled. The results of the limit check are indicated by red or green values in the result summary.

### 7.3.3 How to Export the Trace Data to a File

The measured data can be stored to an ASCII file, either as raw data (directly from the capture buffer) or as displayed in the diagrams (evaluated trace data). Optionally, a header can be included with additional information on the used measurement settings.

1. Press the TRACE key and select the "Trace Export Config" softkey.
2. Define which type of data to export (raw or trace). By default, trace data is exported.
3. Optionally, enable the header information to be included.
4. To export the traces in **all windows**, select "Export Trace to ASCII File for all Windows".  
To export the traces only for **the currently selected window**, select "Export Trace to ASCII File for Specific Window". To export the data from another window, select it from the "Specifics for" list, then export again.  
In either case, **all** traces of the selected window(s) are exported.
5. Define a file name and storage location and select "OK".  
The data is stored in a file and can be analyzed in an external application.

## 8 Measurement Examples

Some sample measurements for the digital GSM and EDGE standards provide a quick introduction to typical vector analyzer measurements. The individual measurements are in logical order and are meant to familiarize you gradually with the measurements required of general vector signal analysis.

The following equipment is required in addition to the R&S FSW with option R&S FSW-K70:

- 1 test transmitter (GSM-compatible for Measurement 2), preferably R&S SMU (1141.2005.02), with the digital standard option GSM/EDGE (order number 1160.7609.02)
- 1 ParData Adapter R&S SMU-Z5 for R&S SMU (1160.4545.02)
- 1 RF cable with 2 male N connectors
- 2 RF cable with 2 male BNC connectors
- 2 power cables

Transmitter operation is only described as far as required for performing the measurements. For more details on the measurements, refer to the test transmitter documentation.

### 8.1 Connecting the Transmitter and Analyzer

In order to perform measurements with the R&S FSW-K70, you require a test transmitter to emulate a DUT. For [Measurement Example 2: Burst GSM EDGE Signals](#), the test transmitter needs to be GSM-compatible.

Connect the RF output of the R&S SMU with the RF input of the R&S FSW.

## Measurement Example 1: Continuous QPSK Signal

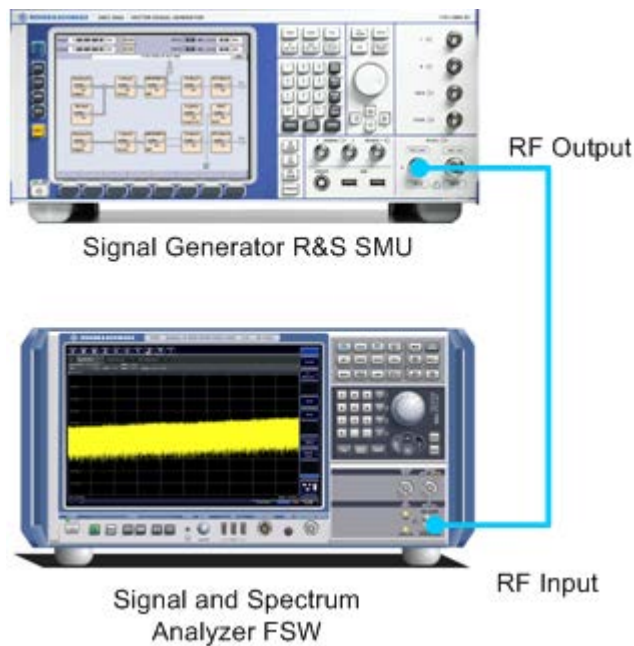


Fig. 8-1: Connection to a test transmitter (for example R&S SMU)

## 8.2 Measurement Example 1: Continuous QPSK Signal

In this measurement example a continuous QPSK (Quadrature Phase Shift Keying) signal will be measured and evaluated. QPSK is used in several standards such as DVB-S2, APCO25, WCDMA, CDMA2000, etc. For the description (characterization) of a continuous QPSK signal, the following parameters are the most important:

- Carrier Frequency
- Level
- Symbol Rate
- Transmit Filter

### 8.2.1 Transmitter Settings

This section summarizes the necessary transmitter settings. It contains a list of the parameters and step-by-step instructions for the R&S SMU. If you are interested in a more detailed description or background information, refer to the user manual of the R&S SMU, which can be downloaded from the Rohde&Schwarz website: [www.rohde-schwarz.com/downloads/manuals/smu200A.html](http://www.rohde-schwarz.com/downloads/manuals/smu200A.html).

Frequency	1 GHz
Level	0 dBm
Modulation	QPSK

## Measurement Example 1: Continuous QPSK Signal

Symbol Rate	1 Msym/s
Filter	Root Raised Cosine with Roll-Off 0.35

**To define the settings for the R&S SMU**

1. Press the PRESET key to start from a defined state.
2. Press the FREQ key and enter *1 GHz*.
3. Press the LEVEL key and enter *0 dBm*.
4. To define the modulation:
  - a) Press the DIAGRAM key.
  - b) Select the first block ("Baseband A") in the settings overview and press ENTER.

## Measurement Example 1: Continuous QPSK Signal

- c) Select "Custom Digital Mod...".

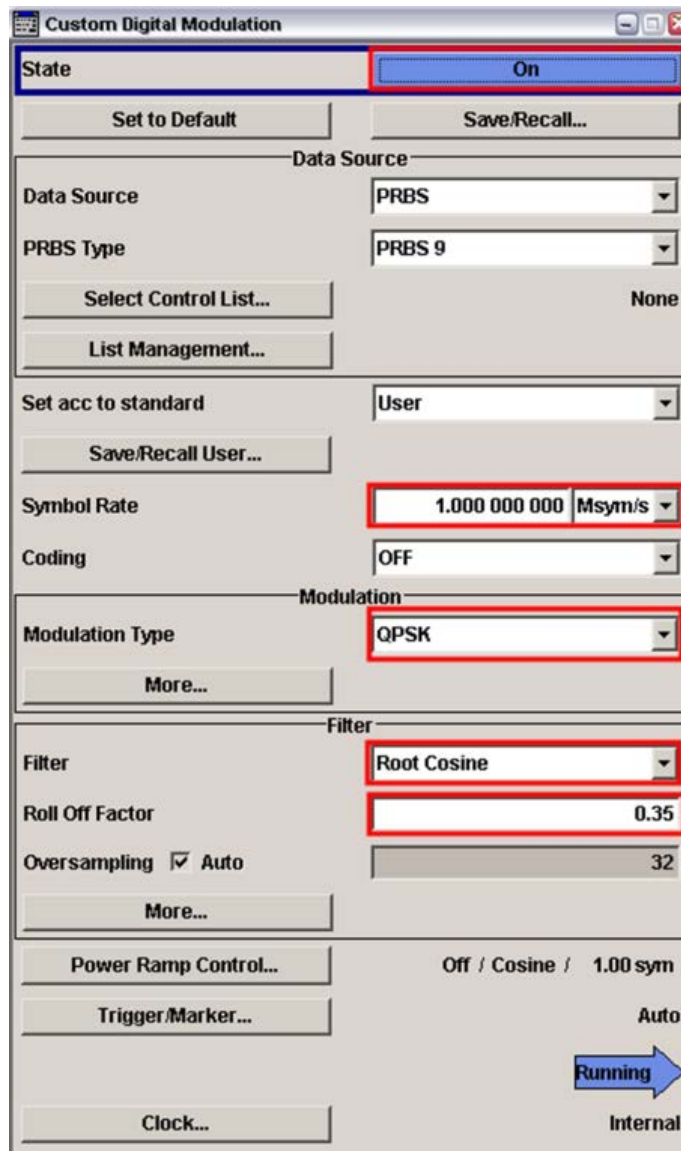


Fig. 8-2: R&S SMU: Custom Digital Modulation Dialog

- d) Under "Modulation Type" select "PSK" > "QPSK".
5. In the "Custom Digital Modulation" dialog box:
- Enter the "Symbol Rate" 1 MHz.
  - Select the "Filter" "Root Cosine".
  - Enter the "Roll Off Factor" 0.35.
  - Toggle the "State" to "On" (at the top of the dialog box) to switch modulation on.
6. Press the RF ON/OFF key to switch the RF transmission on.

## 8.2.2 Analyzer Settings

This section helps you get your first valid measurement. It starts with step-by-step instructions and continues with a more detailed description of further functionality.

Frequency	1 GHz
Ref Level	4 dBm
Modulation	QPSK
Symbol Rate	1 MHz
Tx Filter	Root Raised Cosine with Alpha BT 0.35

### To define the settings on the R&S FSW

1. Press the PRESET key to start from a defined state.
2. Press the FREQ key and enter *1 GHz*.
3. Press the AMPT key, and enter *4 dBm* as the reference level. This corresponds approximately to the peak envelope power of the signal.
4. Start the VSA application by pressing the MODE key and then selecting "VSA".
5. Select the "Overview" softkey to display the "Overview" for VSA.
6. Select the "Signal Description" button and configure the expected signal characteristics.
  - a) In the "Modulation Settings" section, ensure that the "Type" is "PSK" and that the "Order" is "QPSK". The "Mapping" defines the mapping of the bits to the QPSK symbols. It is relevant if you are interested in a bit stream measurement but does not affect the other measurement results. Hence, you do not need to change it here.
  - b) Enter the "Symbol Rate" *1 MHz*.

## Measurement Example 1: Continuous QPSK Signal

- c) In the "Transmit Filter" section, select "RRC" as "Type" and enter the "Alpha/BT" value 0.35. In the preview area of the dialog you should then see a non-distorted QPSK constellation diagram, as shown in [figure 8-3](#).

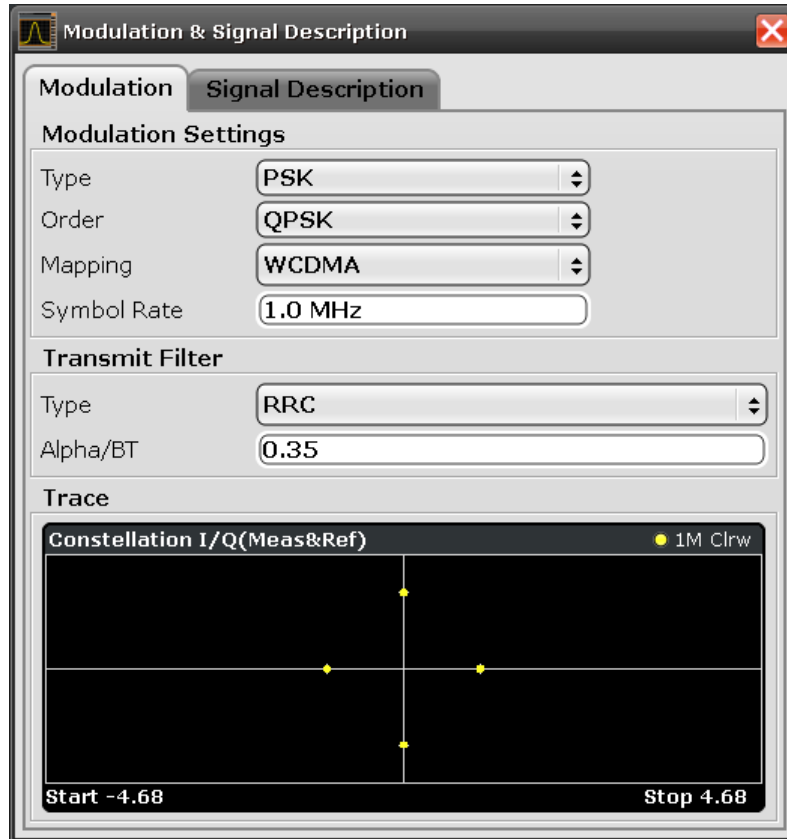


Fig. 8-3: QPSK signal with RRC transmit filter

7. Close all open dialog boxes. By default, four measurement windows showing different measurement results are displayed.



## Measurement Example 1: Continuous QPSK Signal

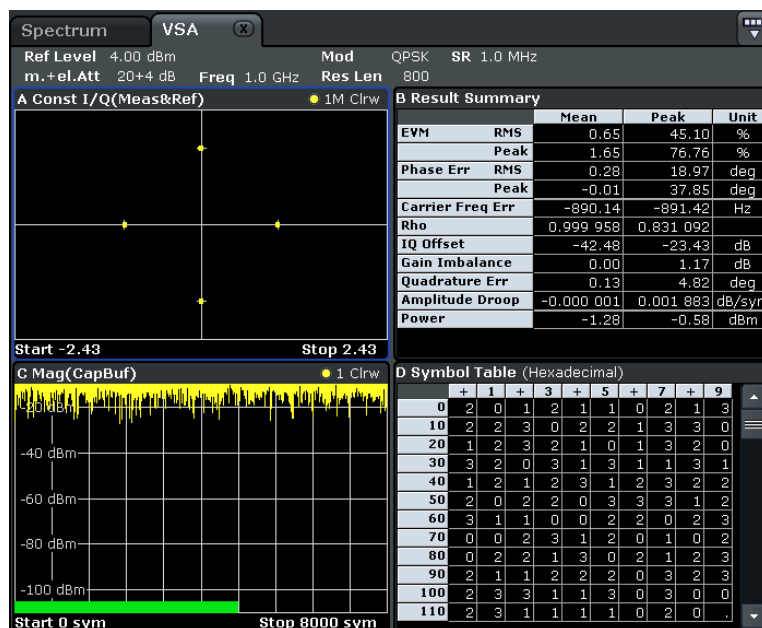




Fig. 8-4: Default window layout for Measurement Example 1

## 8.2.3 Changing the Display Configuration

- To change the window layout, i.e. the display configuration, do one of the following:
  - Select the "Display Config" softkey in the main VSA menu.
  - Select the "Display Configuration" block in the "Overview" (only if "Specifics for" option is disabled).
  - 

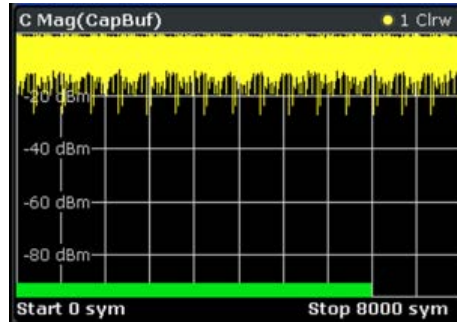
Select the "SmartGrid" icon from the toolbar.
- Replace window 1 by an eye diagram of the inphase component of the measurement signal.
  - Select the "Meas & Ref" data source from the SmartGrid selection bar and drag it over window 1.
  - 

Close the SmartGrid mode by tapping the "Close" icon at the top right corner of the toolbar.
  - Select the "Window Config" softkey.
  - Select the result type: "Eye Diagram Real (I)".
- Close the dialog to take a look at your new display configuration.

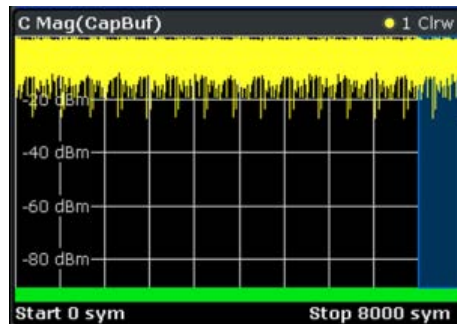
## 8.2.4 Navigating Through the Capture Buffer

Using the R&S FSW VSA application you can navigate through the capture buffer, i.e. control which part of the capture buffer is currently analyzed. (Note: In the Spectrum application, this functionality is referred to as "gating".)

1. In the measurement display, take a closer look at window 3 (magnitude of the capture buffer). The green bar shows how far the current measurement has already proceeded, i.e. how much of the signal has been evaluated.

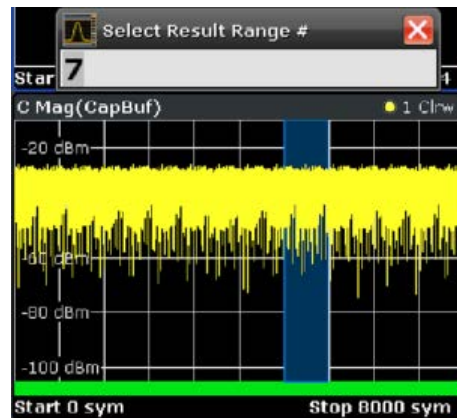


2. Press the RUN SINGLE key. Since the signal you are currently analyzing is continuous (as opposed to containing bursts), the entire capture buffer is analyzed, and hence will be marked with the green bar. The last evaluated result range (i.e. the currently evaluated result range at the time the measurement stopped) is highlighted in blue.



3. To go back to a previously evaluated result range within the same capture buffer, press the SWEEP key and then the "Select Result Rng" softkey. By selecting different result ranges (for example using the rotary knob), you can move the highlighted blue area through the capture buffer and choose your currently demodulated result range.

## Measurement Example 1: Continuous QPSK Signal



The results for this range are displayed in the "Current" column in the Result Summary, in the eye diagram and in the symbol table.

Note: Generally, all Clear/Write traces and the are affected by this selection.

## 8.2.5 Averaging Several Evaluations

By default, all measurement windows are displayed with a single trace, which is the Clear/Write trace. This trace displays the result of the current evaluation, i.e. the highlighted blue area from the example in [chapter 8.2.4, "Navigating Through the Capture Buffer"](#), on page 226. However, for most real-world measurement tasks, you need to obtain a result that is averaged over a certain number of evaluations, or a worst-case result of a certain number of evaluations. This section explains how to achieve this.

### To evaluate EVM vs. Time

1. Configure window 1 such that it displays the EVM versus time measurement (Source: "Error Vector", Result Type: "EVM", see [chapter 8.2.3, "Changing the Display Configuration"](#), on page 225). Tap in the window to set the focus on it.
2. To display the trace averaged over several measurements, or the maximum hold trace over several measurements, press the TRACE key.
3. Add further traces by pressing the TRACE key and then either using the "Trace 2/3..." or the "Trace Config" softkeys.  
Set the second trace to "Average" and the third trace to "Max Hold".  
Note that the configured traces appear in the window title.

## Measurement Example 2: Burst GSM EDGE Signals

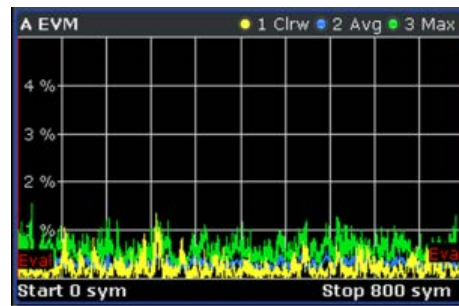


Fig. 8-5: Several traces in one window

4. Press RUN SINGLE again.

The current capture buffer is evaluated for this trace setup. In the channel information bar you can see the number of completed evaluations ("Stat Count").



5. To change the number of evaluations, press the SWEEP key and select "Statistic Count Config".  
Select "Manual" and enter the desired number of evaluations, e.g. 12. When you press RUN SINGLE, the VSA application will capture I/Q data until 12 evaluations are completed.

## 8.3 Measurement Example 2: Burst GSM EDGE Signals

In this measurement example a bursted GSM EDGE signal will be measured and evaluated. The goal of this section is to familiarize you with the VSA application features that are relevant specifically for the analysis of bursted signals.

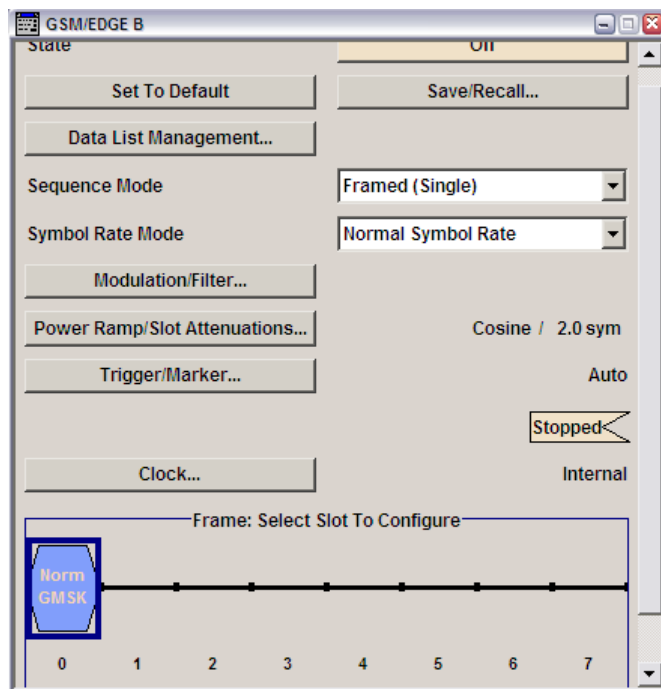
### 8.3.1 Transmitter Settings

This section summarizes the necessary transmitter settings. It contains a list of the parameters and step-by-step instructions for the R&S SMU. If you are interested in a more detailed description or background information, refer to the user manual of the R&S SMU, which can be downloaded from the Rohde&Schwarz website: [www.rohde-schwarz.com/downloads/manuals/smu200A.html](http://www.rohde-schwarz.com/downloads/manuals/smu200A.html).

Frequency	1 GHz
Level	0 dBm
Standard	GSM EDGE Burst with normal symbol rate

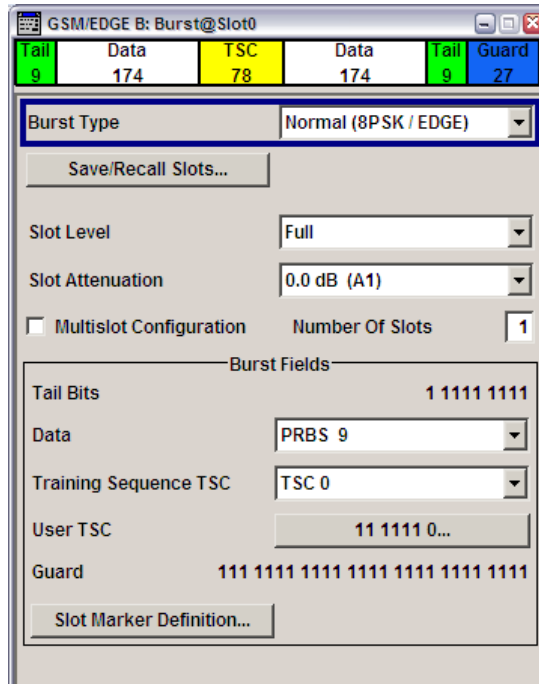
**To define the settings for the R&S SMU**

1. Press the PRESET key to start from a defined state.
2. Press the FREQ key and enter *1 GHz*.
3. Press the LEVEL key and enter *0 dBm*.
4. To define the standard:
  - a) Press the DIAGRAM key.
  - b) Select the first block ("Baseband A") in the settings overview and press ENTER.
  - c) Select "GSM/EDGE...".
  - d) Highlight the first slot in the frame diagram and press ENTER.



**Fig. 8-6: R&S SMU: GSM/EDGE Frame Configuration Dialog**

- e) Select the "Burst Type" "Normal (8PSK / EDGE)".



- f) Close the "GSM/EDGE: Burst@Slot0" dialog box.
- Toggle the "State" to "On" (at the top of the "GSM/EDGE" dialog box) to switch the modulation on.
  - Press the RF ON/OFF key to switch the RF transmission on.



### 8.3.2 Analyzer Settings

This section helps you get your first valid measurement with a bursted signal. It starts with step-by-step instructions and continues with a more detailed description of further functionality.

Frequency	1 GHz
Ref Level	4 dBm
Standard	GSM 8PSK EDGE

#### To define the settings on the R&S FSW

- Press the PRESET key to start from a defined state.
- Press the FREQ key and enter *1 GHz*.

## Measurement Example 2: Burst GSM EDGE Signals

3. Press the AMPT key, and enter 4 dBm as the reference level. This corresponds approximately to the peak envelope power of the signal.
4. Start the VSA application by pressing the MODE key and then selecting "VSA".
5. Select the "Overview" softkey to display the "Overview" for VSA.
6. Press the MEAS key, then select the "Digital Standards" softkey.
7. From the file selection list, select the GSM folder and then the file EDGE\_8PSK. Select "Load".

Predefined settings corresponding to the selected standard are loaded. The VSA application should show good measurement results.

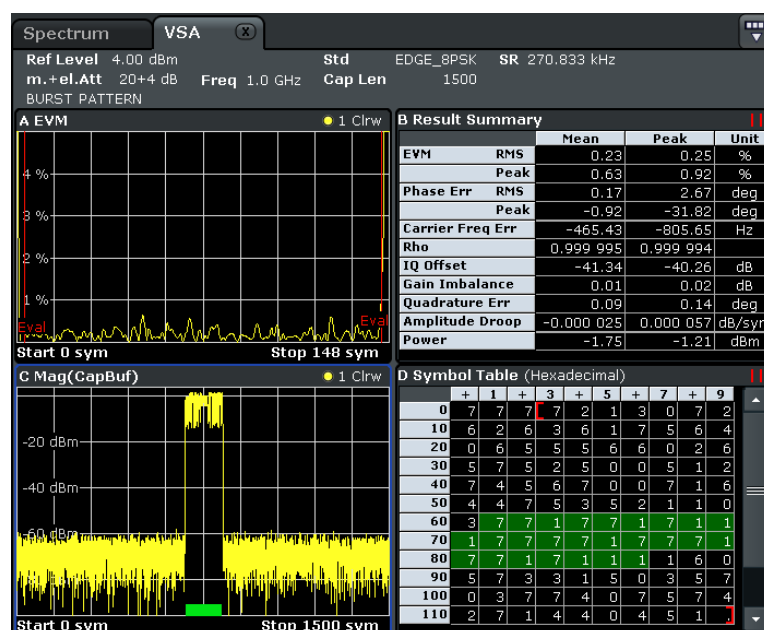


Fig. 8-7: Default display configuration for GSM 8PSK EDGE

8. In window 3, you see the currently evaluated burst marked with a green bar. To include more bursts in the display you need to increase the capture length.
  - a) Press the MEAS CONFIG key and then the "Overview" softkey.
  - b) Select "Signal Capture".
  - c) Increase the "Capture Length", e.g. to 10000 symbols.

In the preview area of the dialog box you see that more bursts are now contained in the capture buffer. They are all marked with a green bar, meaning that they are all evaluated.

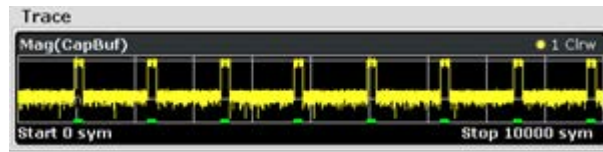




Fig. 8-8: Preview of capture buffer

### 8.3.3 Navigating Through the Capture Buffer

This example describes how to navigate through the capture buffer for a continuous signal. This navigation feature is especially important for bursted signals. Therefore, we provide a further navigation example for the GSM EDGE signal.

1. In order to see more details in the capture buffer, close window 4.
  - a) Press the "Display Config" softkey, or the "Display Configuration" button in the "Overview".
  - b) Select the  "Delete" icon for window 4.
  - c) 

Close the SmartGrid mode by tapping the "Close" icon at the top right corner of the toolbar.

2. Press the RUN SINGLE key.
3. In the "EVM vs. Time" display (window 1), add a maximum hold trace by pressing the TRACE key and then selecting the "Trace Config" softkey (see [chapter 8.2.5, "Averaging Several Evaluations"](#), on page 227).
4. Re-evaluate the whole capture buffer by pressing the SWEEP key and then the "Refresh" softkey.
5. Use the "Select Result Rng" softkey to navigate through your capture buffer. Thus, you can determine which peak was caused by which burst.



## Measurement Example 2: Burst GSM EDGE Signals

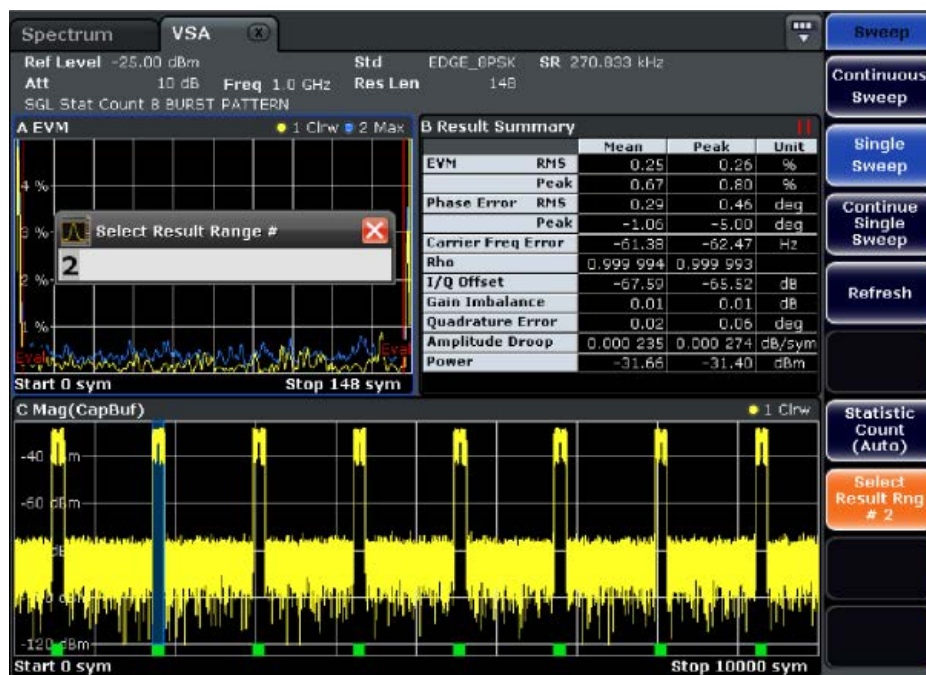


Fig. 8-9: Navigation through the capture buffer

### 8.3.4 Evaluating the Rising and Falling Edges

The "Result Length" is the number of symbols that are to be demodulated and analyzed together. In most common applications, only the parts of the capture buffer containing the bursts need to be analyzed. Hence, for bursted signals the "Result Length" usually coincides with the burst length. However, there are certain scenarios where the rising and falling edge of a burst are also of interest, e.g. checking the power ramping of the device under test. For this measurement task, it is useful to choose a "Result Length" that exceeds the burst length.

1. In order to include the rising and falling edges of the bursts in the EVM vs Time display (window 1), you need to increase the "Result Length".  
In the "Overview", select "Cut Result Range" and increase the "Result Length" to 200 symbols.
2. To evaluate the rising and falling edges further, display the absolute magnitude values of the measured signal in window 4 (Source: "Meas&Ref Signal", Result type: "Magnitude Absolute", see [chapter 8.2.3, "Changing the Display Configuration"](#), on page 225).
3. Press RUN SINGLE.

The rising and falling edges of the burst in the selected result range are displayed in window 4. You could now add an average trace to evaluate the rising and falling edges further.

## Measurement Example 2: Burst GSM EDGE Signals



Fig. 8-10: Result range that exceeds the burst length

### 8.3.5 Setting the Evaluation Range

In some scenarios, such as in [Evaluating the Rising and Falling Edges](#), the result range contains symbols that are not supposed to be considered for the EVM or other calculated parameters that are displayed in the Result Summary. Thus, you would not include them in the evaluation range.

#### To change the evaluated data

1. Start from the configuration described in [chapter 8.3.4, "Evaluating the Rising and Falling Edges"](#), on page 233.
2. Display the I/Q constellation diagram of the signal in window 1 (Source: "Meas&Ref Signal", Result type: "Constellation I/Q", see [chapter 8.2.3, "Changing the Display Configuration"](#), on page 225).

A clear 8PSK constellation is displayed.



Fig. 8-11: Evaluation lines properly adjusted

## Measurement Example 2: Burst GSM EDGE Signals

3. In order to understand the effect of an incorrectly set evaluation range, change the evaluation range to include the entire result range.
  - a) In the "Overview", select "Evaluation Range".
  - b) Enable the "Entire Result Range" option.

The displayed constellation diagram is no longer clear, it contains additional points. This is due to the fact that the constellation diagram now displays symbol instants that are beyond the burst.

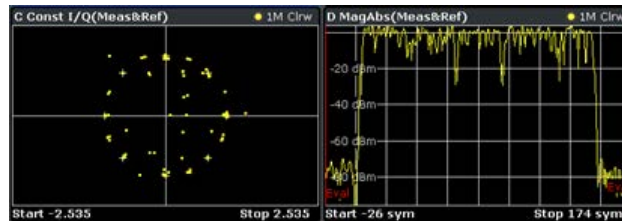
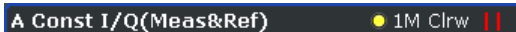


Fig. 8-12: Evaluation lines not properly adjusted



All measurement windows that consider the evaluation range are marked with two small red lines in the title bar.





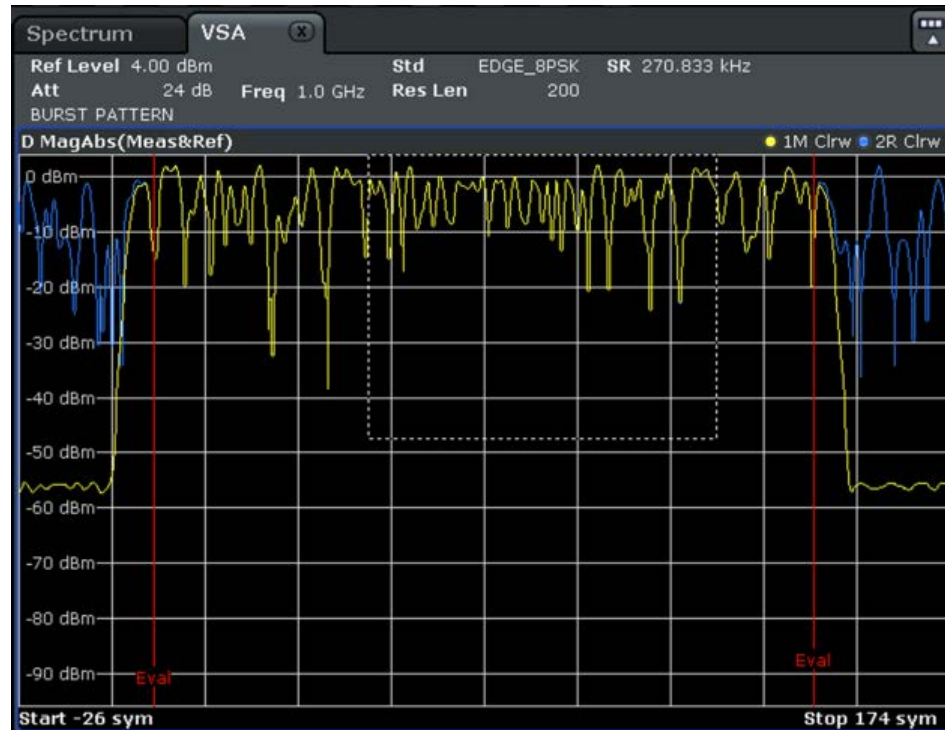
### 8.3.6 Comparing the Measurement Signal to the Reference Signal

You have seen that it is possible to add different traces such as maximum hold or average to each window. When evaluating the measurement signal it is also possible to display the ideal reference signal as an additional trace. This can be a significant help when troubleshooting, since it allows for an immediate comparison.

1. Start from the configuration described in [chapter 8.3.4, "Evaluating the Rising and Falling Edges"](#), on page 233.
2. Select window 4 to set the focus on it.
3. Press the TRACE key and then the "Trace 2" softkey.
4. Select "Clear Write" as the "Trace Mode" and "Evaluation: Ref". This adds a second trace to your result display. This trace is the ideal reference signal that can now be compared to the measurement signal (see [figure 8-13](#)).

## Measurement Example 2: Burst GSM EDGE Signals

- To view the traces in more detail, enlarge the window using the "Split/Maximize" key () , and zoom into the display using the  icon in the toolbar (see the dotted rectangle in [figure 8-13](#)).



*Fig. 8-13: Zooming*

Now you can compare the measured and the ideal reference signal.

## 9 Optimizing and Troubleshooting the Measurement

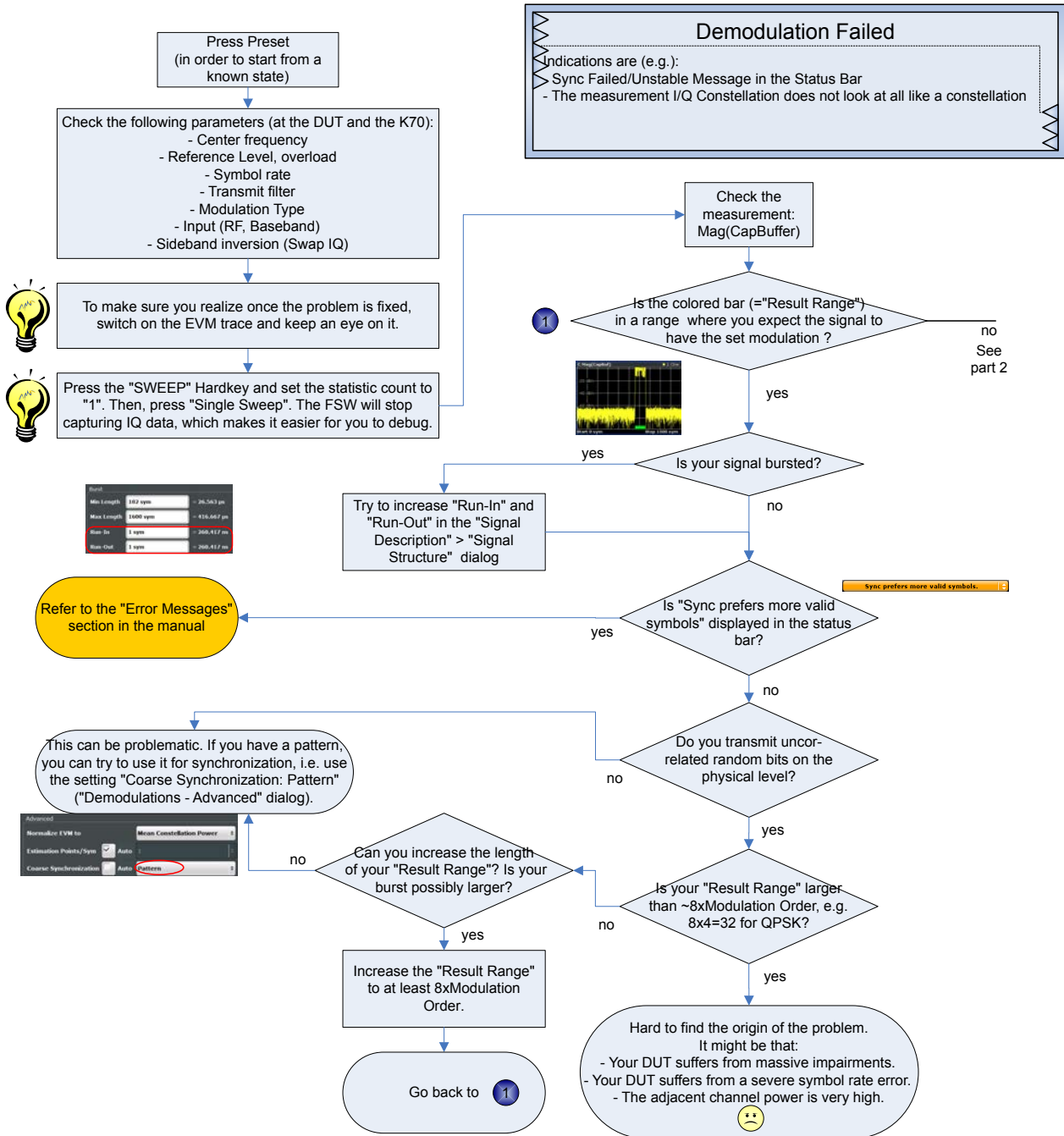
If the results do not meet your expectations, the following tips may help you optimize or troubleshoot the measurement.

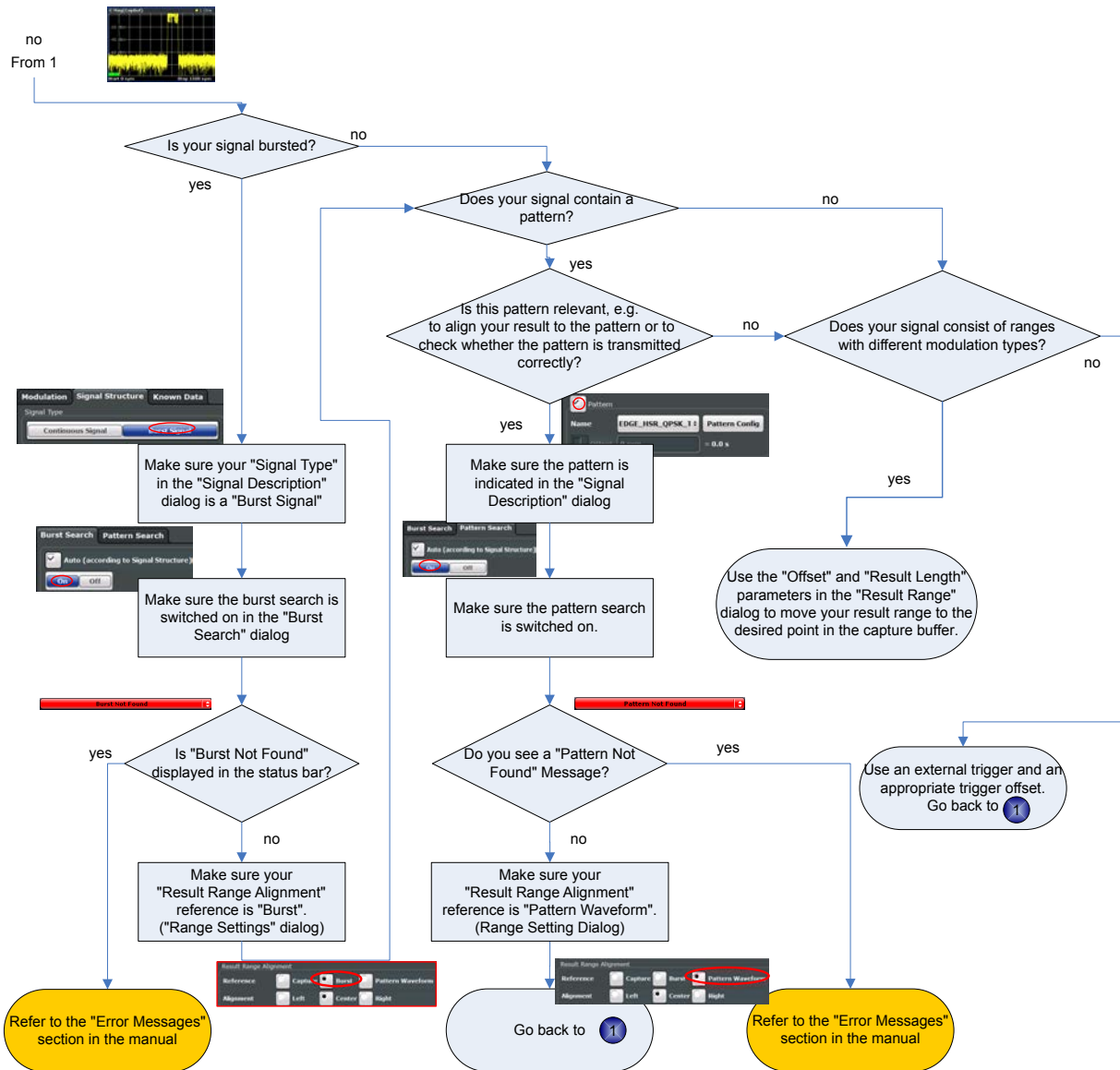
- [Flow Chart for Troubleshooting](#).....237
- [Explanation of Error Messages](#).....239
- [Frequently Asked Questions](#).....248
- [Obtaining Technical Support](#).....255

### 9.1 Flow Chart for Troubleshooting

If you experience a concrete measurement problem, you might want to try solving it with the help of the flow chart.

Troubleshooting Overview





## 9.2 Explanation of Error Messages

The following section describes error messages and possible causes.

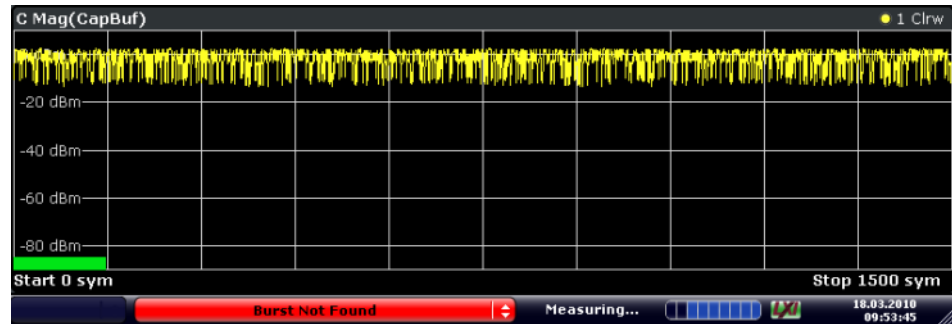
Message: 'Burst Not Found'.....	240
Message: 'Pattern Not Found'.....	242
Message: 'Result Alignment Failed'.....	244
Message: 'Pattern Search On, But No Pattern Selected'.....	245
Message: 'Pattern Not (Entirely) Within Result Range'.....	245
Message: 'Short Pattern: Pattern Search Might Fail'.....	245
Message: 'Sync Prefers More Valid Symbols'.....	246
Message: 'Sync Prefers Longer Pattern'.....	247
Message: 'Result Ranges Overlap'.....	248



**Message: 'Burst Not Found'**

The "Burst Not Found" error message can have several causes:

- **Burst search is active, but the signal is not bursted**



*Fig. 9-1: Example for active burst search with continuous signal*

Solution: Select "Continuous Signal" as the signal type.

For more information, see

- ["Signal Type"](#) on page 132.

- **Signal is bursted, but bursts have not been captured completely**

The burst search can only find bursts that start and end within the capture buffer. It ignores bursts that are cut off.



*Fig. 9-2: Example for incomplete burst capture*

Solution: Change the trigger settings and/or enlarge the capture length.

For more information, see

- [chapter 5.6, "Signal Capture"](#), on page 151

- **The current measurement is being performed on a burst that has not been captured completely.**





Fig. 9-3: Example for measurement on incomplete burst capture

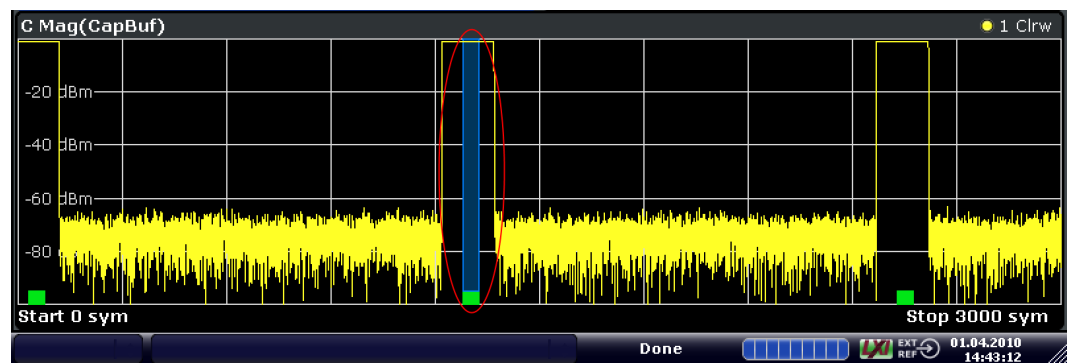


Fig. 9-4: Example for measurement on complete burst capture

Solution:

Change the trigger settings or increase the result length.

Note, however, that in this case, the results are actually correct and the message can be ignored.

- **The settings do not match the signal**

In order to allow you to select certain bursts, the burst search only searches for bursts that have a length between "Min Length" and "Max Length" (plus a tolerance that you can set in the "Burst Search" Dialog). In case the burst is, e.g. shorter than the "Burst Min Length", the burst search fails.

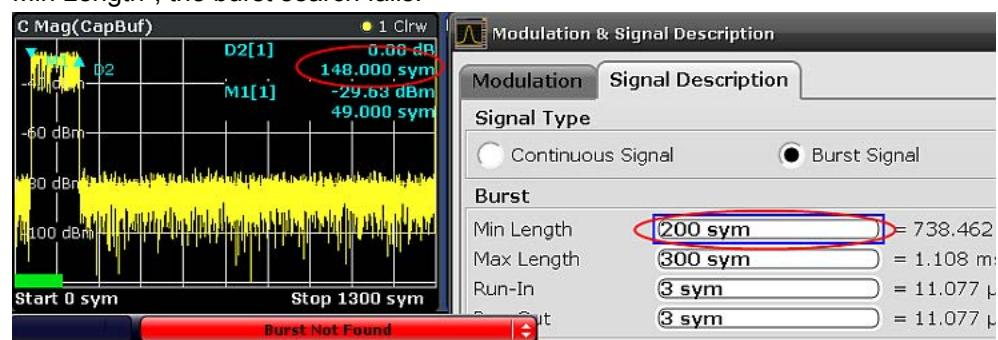


Fig. 9-5: Example for a failed burst search due too a burst that is too short

Solution: try one of the following:

- Switch on the Magnitude (Capture Buffer) result display. Move a marker to the start of the burst. Move a delta marker to the end of the burst and compare the burst length to the settings in the "Signal Description" dialog.
- Increase the search tolerance in the "Burst Search" dialog. Keep an eye on the green/red field. If the burst search succeeds, you can see the length of the found bursts.
- Set the minimum burst length to 50 and the maximum burst length to 5000.

For more information, see:

- "Burst Settings" on page 132
- "Burst Configuration" on page 162
- **The signal is highly distorted and/or has modulation noise**  
One possibility to enhance the robustness of the burst search is to increase the minimum gap length. If the bursts within your capture buffer are not closely spaced, it makes sense to increase the value of this parameter.

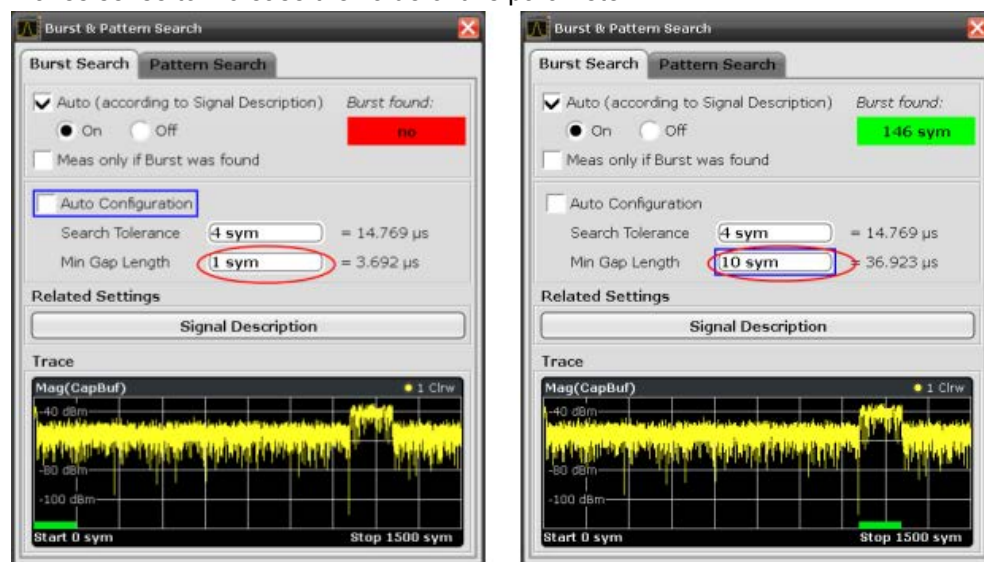


Fig. 9-6: Example for adjusting the minimum gap length

For more information, see "Min Gap Length" on page 162

- **The pattern search is switched on, fails and the alignment is with reference to the pattern.**

In case the pattern search is switched on and the reference for the alignment is the pattern (and not the burst), a non-detected pattern causes the result range to be positioned at the beginning of the capture buffer. Hence, if a the burst does not start right at the beginning of the capture buffer, you will see a "Burst Not Found" Message.  
Solution:

- Refer to "Message: 'Pattern Not Found'" on page 242
- Switch the pattern search off.
- Choose "Burst" as the reference for the result range alignment.

#### Message: 'Pattern Not Found'

The "Pattern Not Found" error message can have several causes:

- **The burst search has failed**

If burst and pattern search are active, the application looks for patterns only within the found bursts. Hence, in case the burst search fails, the pattern search will also fail.

Solution: Try one of the following:

- Make sure the burst search is successful.
- Deactivate the burst search but keep the pattern search active.

For more information, see

- "Message: 'Burst Not Found'" on page 240
- chapter 5.7.1, "Burst Search", on page 161

- **The offset of the pattern within the burst is incorrectly set**

It is possible to set a pattern offset to speed up the pattern search. The offset of the pattern would be the offset of the pattern start with respect to the start of the useful part of the burst. However, if the entered offset is not correct (within about 4 symbols of tolerance), the pattern will not be found.

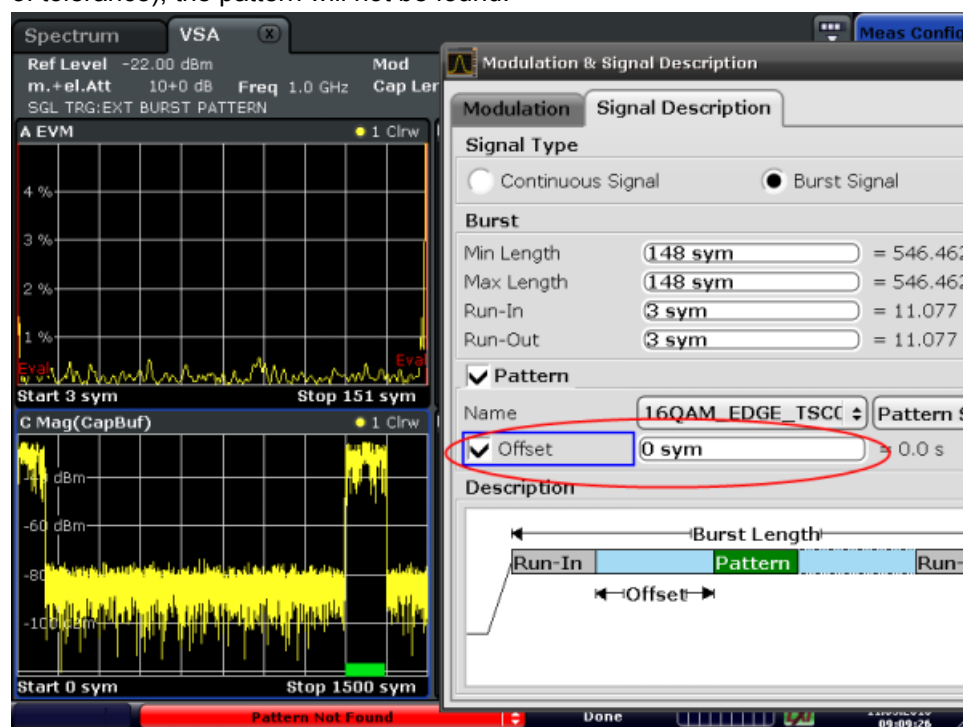


Fig. 9-7: GSM EDGE burst; Pattern is actually located in the middle of the burst. The correct value for "Offset" here would be 58.

Solution: Try one of the following:

- Remove the offset ('unknown').
- Enter the correct offset (within about 4 symbols of tolerance).

For more information, see

- "Offset" on page 133

- The specified pattern does not coincide with the pattern in your signal:

In the R&S FSQ-K70 it is possible to search for multiple patterns at the same time. For example, in a GSM measurement, the capture buffer can be checked for all TSCs simultaneously. This is not possible in the R&S FSW-K70.

Solution:

Make sure that the correct pattern is specified in the "Signal Description" dialog.

For more information, see

- [chapter 5.4, "Signal Description"](#), on page 126

### Message: 'Result Alignment Failed'

The result range alignment is not possible for the particular capture buffer. The result range needs I/Q data that has not been captured.

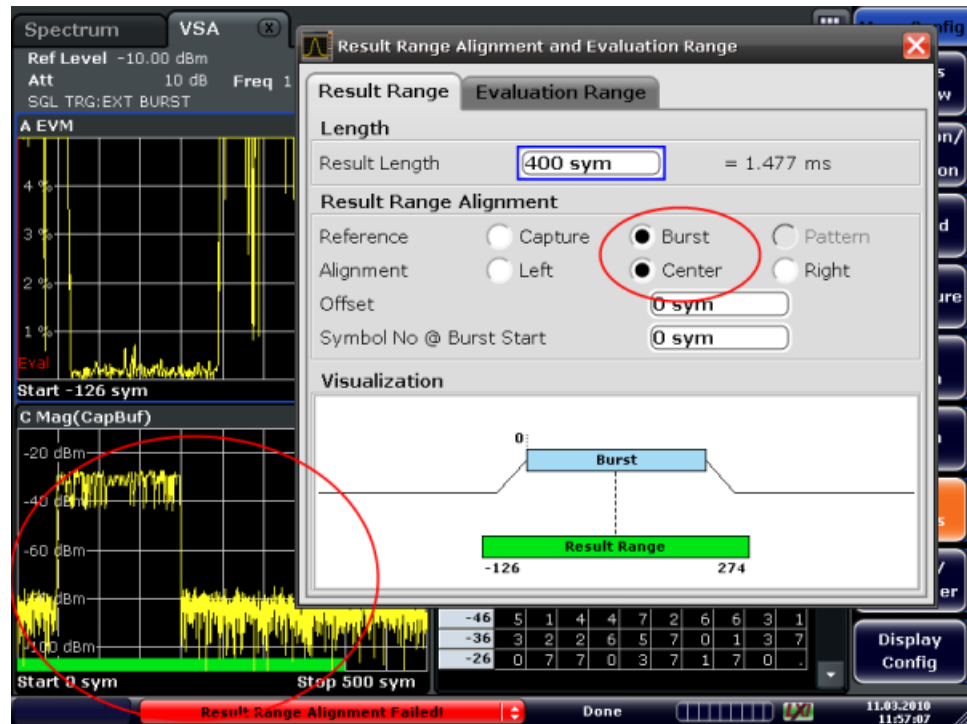


Fig. 9-8: Example for failed alignment

In this windowshot, the alignment of the long result range to the burst center is not possible because there are not enough samples in the capture buffer before the burst starts. In this scenario, the trigger settings should be changed such that the burst is in the middle of the capture buffer.

Solution: Change the trigger settings and/or enlarge the capture length.

For more information, see:

- [chapter 5.6, "Signal Capture"](#), on page 151

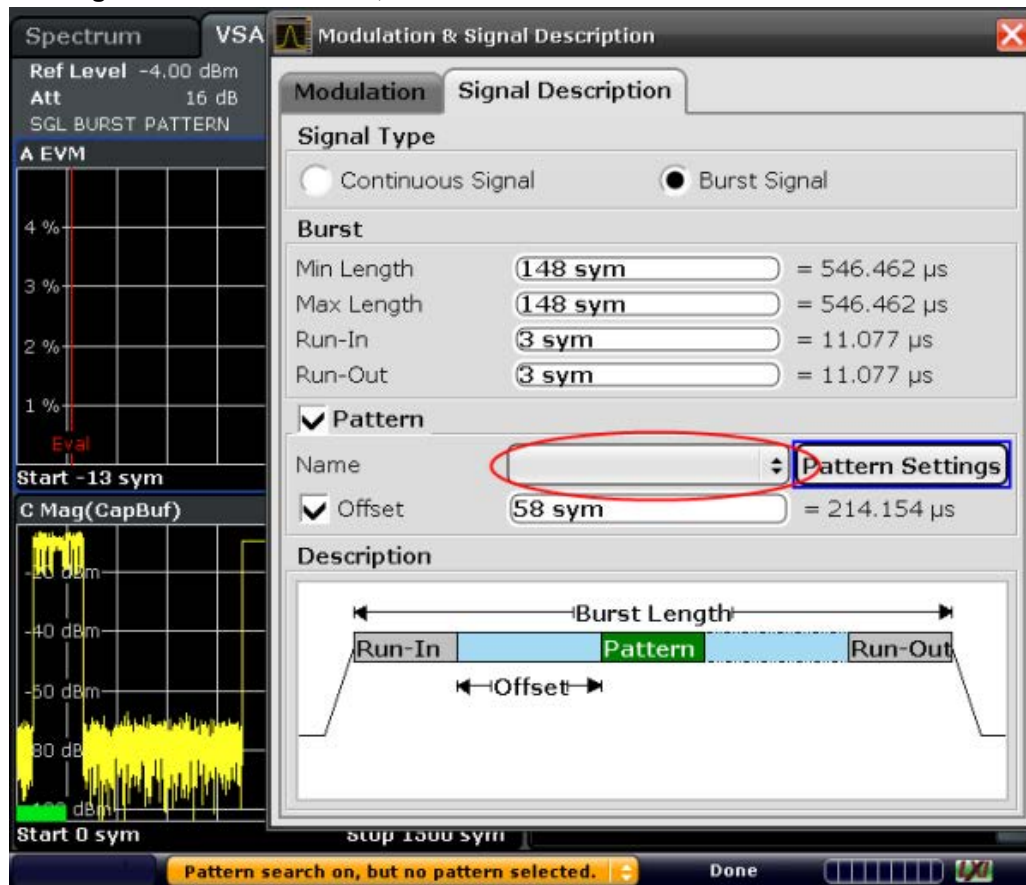
**Message: 'Pattern Search On, But No Pattern Selected'**

Fig. 9-9: The red circle shows the place where you can specify a pattern

Solution: Select an existing pattern (or create a new pattern) that you expect to be within the signal.

For more information, see

- ["Pattern Settings"](#) on page 132
- [chapter 7.2.2, "How to Perform Pattern Searches"](#), on page 204

**Message: 'Pattern Not (Entirely) Within Result Range'**

A pattern can only be found, if it is entirely within the result range. Therefore, this error message always occurs with a "Pattern Not Found" error.

Solution: Choose the pattern as reference of your result range alignment. Then, the pattern will be forcefully part of your result range and the pattern search can succeed.

For more information, see

- [chapter 5.8, "Result Range Configuration"](#), on page 169
- [chapter 7.2.4, "How to Define the Result Range"](#), on page 211

**Message: 'Short Pattern: Pattern Search Might Fail'**

The R&S FSW performs the pattern search in two stages.

- Stage 1 involves the generation of an I/Q pattern waveform by modulating the pattern symbol sequence. The I/Q pattern is then correlated with the measured signal. At

positions where the correlation metric exceeds the "I/Q Correlation Threshold" the I/Q pattern is found.

- Stage 2 demodulates the measured signal at the I/Q pattern location and the transmitted symbols are checked for correctness against the pattern symbol sequence.

In case of a very short pattern, i.e. a pattern length in the order of the inter-symbol interference (ISI) duration, a number of issues can arise:

- False positive  
The I/Q pattern is found at positions where the transmitted symbols differ from the pattern symbols.  
Solution: Try one of the following:
  - Activate "Meas only if Pattern Symbols Correct".
  - Increase the "I/Q Correlation Threshold" (see [chapter 5.7.2, "Pattern Search"](#), on page 163).
- False negative  
The I/Q pattern search misses a position where transmitted symbols match the pattern symbols.  
Solution:
  - Decrease the "I/Q Correlation Threshold" (see [chapter 5.7.2, "Pattern Search"](#), on page 163).

In case of bursted signals the pattern search finds only the first occurrence of the I/Q pattern within each burst. If a false positive occurs in this situation (cf. case 1.) the use of "Meas only if pattern symbols correct" will not provide a satisfactory solution.

In this case do the following:

- Increase the "I/Q Correlation Threshold".
- Specify the expected position of the pattern within the burst by adjusting the "Offset" parameter.

#### **Message: 'Sync Prefers More Valid Symbols'**

**Note:** Note that this message does not necessarily indicate a problem. Its purpose is to inform you that you might have the opportunity to get a more stable demodulation and/or better measurement results by improving your setup.

Synchronization in the VSA application is performed in two stages: coarse synchronization that precedes the reference signal generation and fine synchronization based on the reference signal.

- The coarse synchronization stage can work data-aided (i.e. based on a known pattern) or non-data-aided (i.e. based on the unknown data symbols). The default is a non-data-aided coarse synchronization. In the case that a pattern is part of signal, the user can switch to data-aided synchronization.
- The fine synchronization stage always works data-aided.

'Sync Prefers More Valid Symbols' indicates that one of the synchronization stages has too few symbols to ensure that the synchronization is robust.

The message is given if

- Coarse Synchronization = Non-Data-Aided (User Pattern for Sync = Off):  
Estimation range shorter than 40 symbols  
(see [chapter 4.5.1.2, "Estimation"](#), on page 97)
- Fine Synchronization:  
Estimation range shorter than 10 symbols  
(see [chapter 4.5.1.2, "Estimation"](#), on page 97)



Solution:

- If the signal contains a pattern, set "Coarse Synchronization: Pattern".  
(see "[Coarse Synchronization](#)" on page 177).

Example: measurement of a GSM EDGE pattern that has a length of 26 symbols.

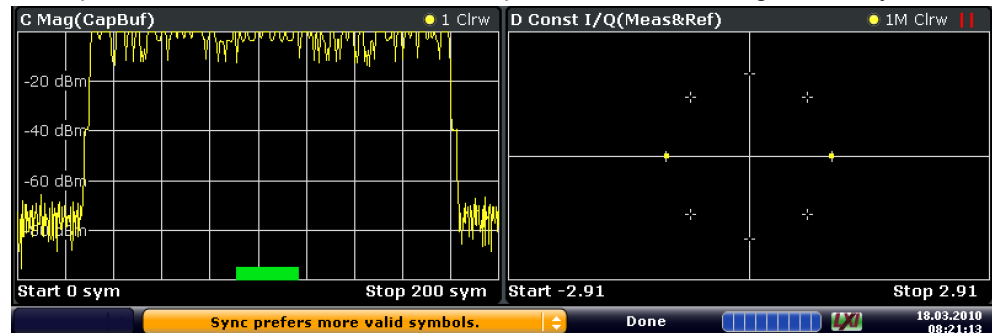


Fig. 9-10: User Pattern for Sync = Off

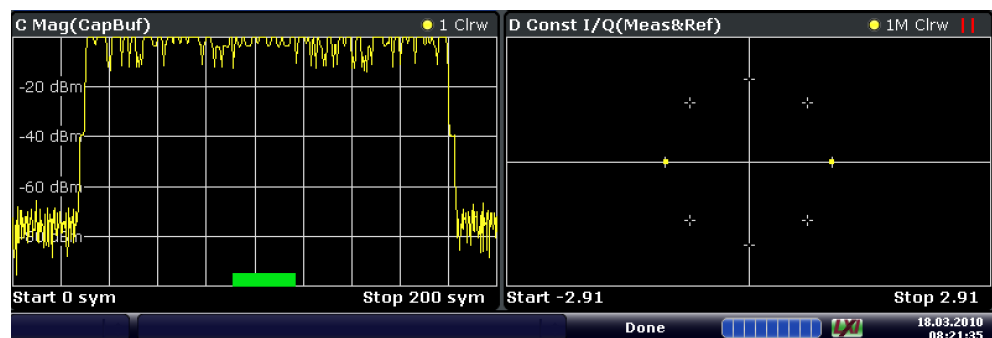


Fig. 9-11: User Pattern for Sync = On

- Choose a longer "Result Range".
- If the signal is bursted and the bursts are short:
  - Make sure your "Result Range" comprises the entire burst.
  - Make sure that "Run-In/Out" is not chosen too large, since the "Run-In/Out" ranges are excluded from the synchronization.
- If the signal is bursted and contains a pattern:
 

Only switch off the burst search if absolutely necessary. If you need to switch it off, align your "Result Range" to the pattern, make sure it does not exceed the burst ramps and choose "Continuous Signal" as the "Signal Type" in the "Signal Description" dialog.

For more information, see

- [chapter 4.4, "Overview of the Demodulation Process"](#), on page 84

#### Message: 'Sync Prefers Longer Pattern'

This message can only occur if the coarse synchronization is data-aided, i.e. is based on a known pattern. In case the pattern is very short, pattern-based coarse synchronization might be unstable. If demodulation is stable, e.g. you get a reasonable EVM, there is no need to change anything. Otherwise, you have two options:

- Switch to the non-pattern-based mode by setting the parameter "Coarse Synchronization: Data"  
(see "[Coarse Synchronization](#)" on page 177)

- If possible, use a longer pattern.

For more information, see

- [chapter 4.4, "Overview of the Demodulation Process"](#), on page 84

**Message: 'Result Ranges Overlap'**

This message does not indicate an error. It is merely displayed to inform you that the defined result ranges in the capture buffer overlap. Thus, some captured data is evaluated more than once. For example, the same peak value may be listed several times if it is included in several result ranges, and averaging is performed on (partially) duplicate values. However, a negative influence on the measurement results is not to be expected.

## 9.3 Frequently Asked Questions

<a href="#">Problem: The trace is not entirely visible within the measurement window</a>	248
<a href="#">Problem: The trace of the measurement signal is visible in the measurement window; the trace of the reference signal is not</a>	248
<a href="#">Problem: The measurement window does not show average results</a>	249
<a href="#">Problem: The spectrum is not displayed in the logarithmic domain</a>	250
<a href="#">Problem: The Vector I/Q result display and the Constellation I/Q result display look different</a>	250
<a href="#">Problem: The Constellation I/Q measurement result display has a different number of constellation points in the R&amp;S FSQ-K70 and the R&amp;S FSW-K70</a>	250
<a href="#">Problem: the MSK/FSK signal demodulates on the R&amp;S FSQ-K70, but not on the R&amp;S FSW-K70 or: Why do I have to choose different transmit filters in the R&amp;S FSQ-K70 and the R&amp;S FSW-K70?</a>	251
<a href="#">Problem: The EVM trace looks okay, but the EVM in the result summary is significantly different</a>	251
<a href="#">Question: Why isn't the FSK Deviation Error in R&amp;S FSW-K70 identical to the FSK DEV ERROR in R&amp;S FSQ-K70?</a>	253
<a href="#">Problem: The PSK/QAM Signal shows spikes in the Frequency Error result display</a>	254
<a href="#">Question: The y-axis unit for the spectrum of the measurement signal can be chosen to be "dB". What level is this relative to?</a>	254
<a href="#">Question: How can I get the demodulated symbols of all my GSM bursts in the capture buffer in remote control?</a>	254
<a href="#">Question: Why do the EVM results for my FSK-modulated signal look wrong?</a>	255

**Problem: The trace is not entirely visible within the measurement window**

Solution:

- 1. Select the measurement window.
- 2. Press the AUTO key.
- 3. Press the "Y-Axis Auto Scale" softkey.

**Problem: The trace of the measurement signal is visible in the measurement window; the trace of the reference signal is not**

Solution:

- 1. Select the measurement window.
- 2. Press the TRACE key.



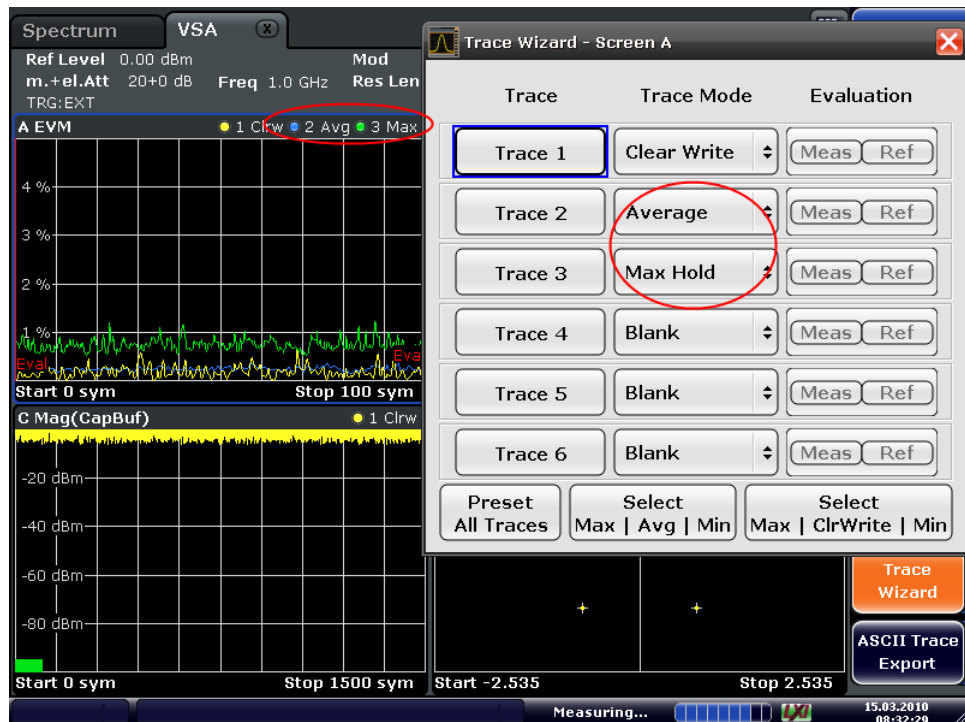
- 3. Press the "Trace Config" softkey.
- 4. Select a second trace, choose "Clear Write" as "Trace Mode" and toggle to "Ref" in the "Evaluation" column.



**Problem: The measurement window does not show average results**

Solution:

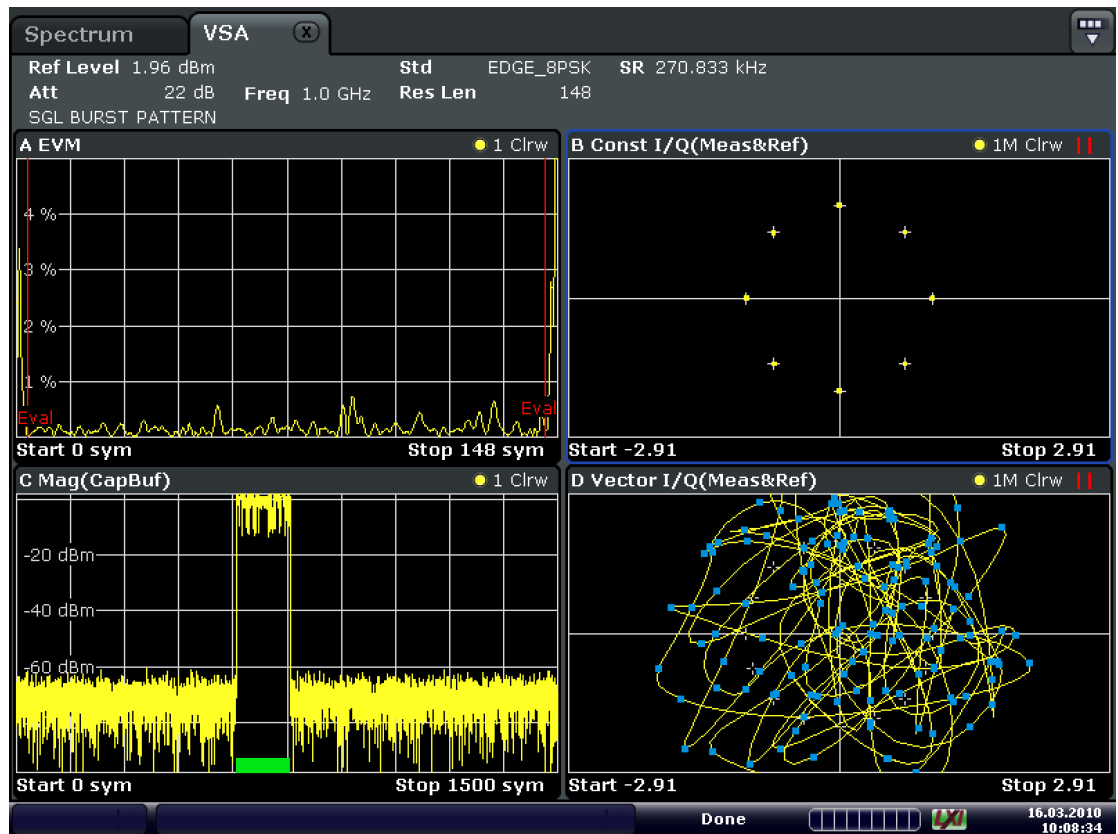
- 1. Select the measurement window.
- 2. Press the TRACE key.
- 3. Press the "Trace Config" softkey.
- 4. Select a second trace and choose the preferred "Trace Mode", e.g. "Max Hold" or "Average".



**Problem: The spectrum is not displayed in the logarithmic domain**

Solution:

- 1. Select the measurement window.
- 2. Press the AMPT key.
- 3. Press the "Unit" softkey.
- 4. Press the "Y-Axis Unit" softkey.
- 5. Select dB.

**Problem: The Vector I/Q result display and the Constellation I/Q result display look different**

Date: 16.MAR.2010 10:08:34

Reason:

- The Vector I/Q diagram shows the measurement signal after the measurement filter and synchronization.
- The Constellation I/Q diagram shows the de-rotated constellation (i.e. for a  $\pi/4$ -DQPSK, 4 instead of 8 points are displayed). The inter-symbol interference has been removed.

In case the measurement filter does not remove the inter-symbol interference, the windows show measurements that are significantly different.

**Problem: The Constellation I/Q measurement result display has a different number of constellation points in the R&S FSQ-K70 and the R&S FSW-K70**

Reason:

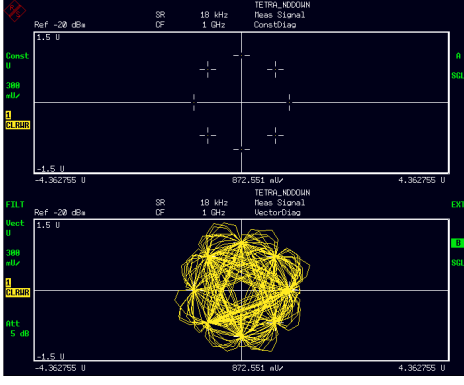
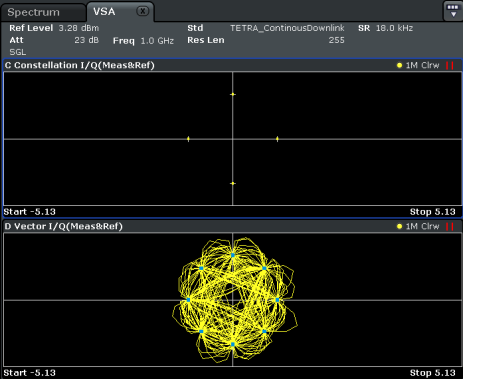
In the FSQ-K70, the Constellation I/Q measurement displays the symbol instants of the Vector I/Q measurement. Hence, this is a rotated constellation, e.g. for a  $\pi/4$ -DQPSK, 8 points are displayed.

In the R&S FSW-K70, the Constellation I/Q diagram shows the de-rotated constellation (i.e. for a  $\pi/4$ -DQPSK, 4 instead of 8 points are displayed). The inter-symbol interference has been removed.

**Note:** The result display "I/Q Constellation (Rotated)" displays the rotated constellation, as the FSQ-K70 does.

For details on the Constellation I/Q diagram in the R&S FSW-K70, see [chapter 3.2.11, "Constellation I/Q"](#), on page 30.

**Table 9-1: Constellation I/Q and Vector I/Q for  $\pi/4$ -DQPSK modulation**

	
R&S FSQ-K70	R&S FSW-K70

**Problem: the MSK/FSK signal demodulates on the R&S FSQ-K70, but not on the R&S FSW-K70 or: Why do I have to choose different transmit filters in the R&S FSQ-K70 and the R&S FSW-K70?**

When generating an MSK/FSK reference signal, the R&S FSQ-K70 automatically replaces the Dirac pulses generated by the frequency mapper with square pulses with the length of one symbol. In the R&S FSW-K70, however, this "replacement" is part of the transmit filter routine. Thus, the R&S FSQ and the R&S FSW require different transmit filters for measuring the same FSK/MSK signal.

**Example:**

- If your transmit filter for the R&S FSQ-K70 was "NONE", you need to choose "Rectangular" as the transmit filter type in the R&S FSW.
- If your transmit filter for the R&S FSQ-K70 was "GAUSS", you need to choose "GMSK" as the transmit filter type in the R&S FSW.

**Problem: The EVM trace looks okay, but the EVM in the result summary is significantly different**

Solution:

- Make sure that the position of the "Evaluation Lines" is reasonable. The Result Summary only evaluates sample instants that are within the evaluation lines. Hence, in the case the "Result Range" covers the burst ramps, it is important to adjust the "Evaluation Range" appropriately.

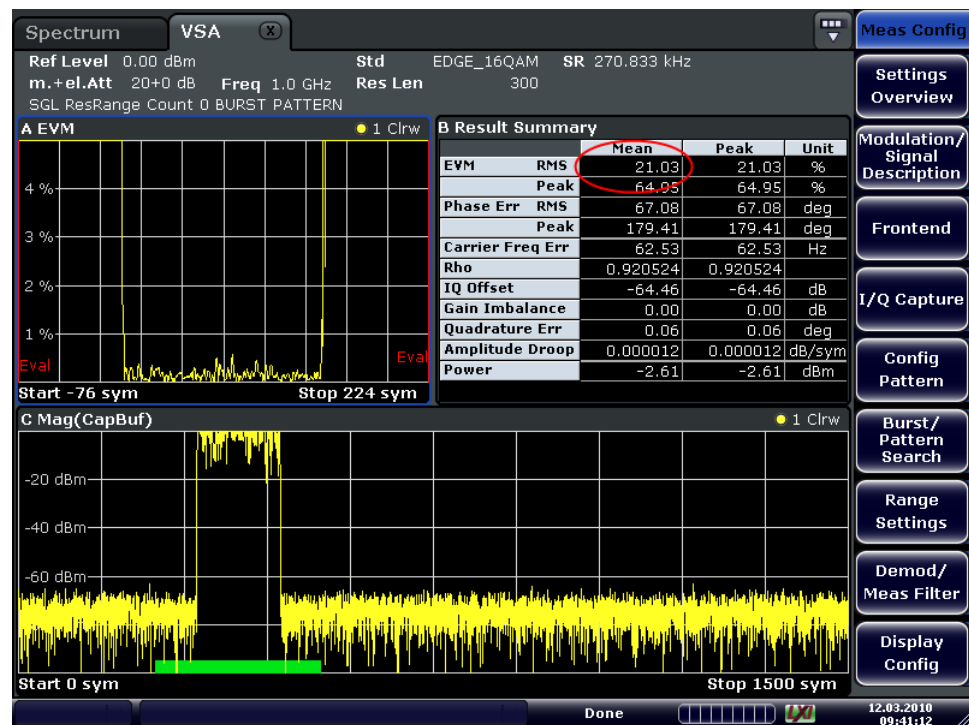


Fig. 9-12: Problem: EVM in result summary does not correspond with trace display

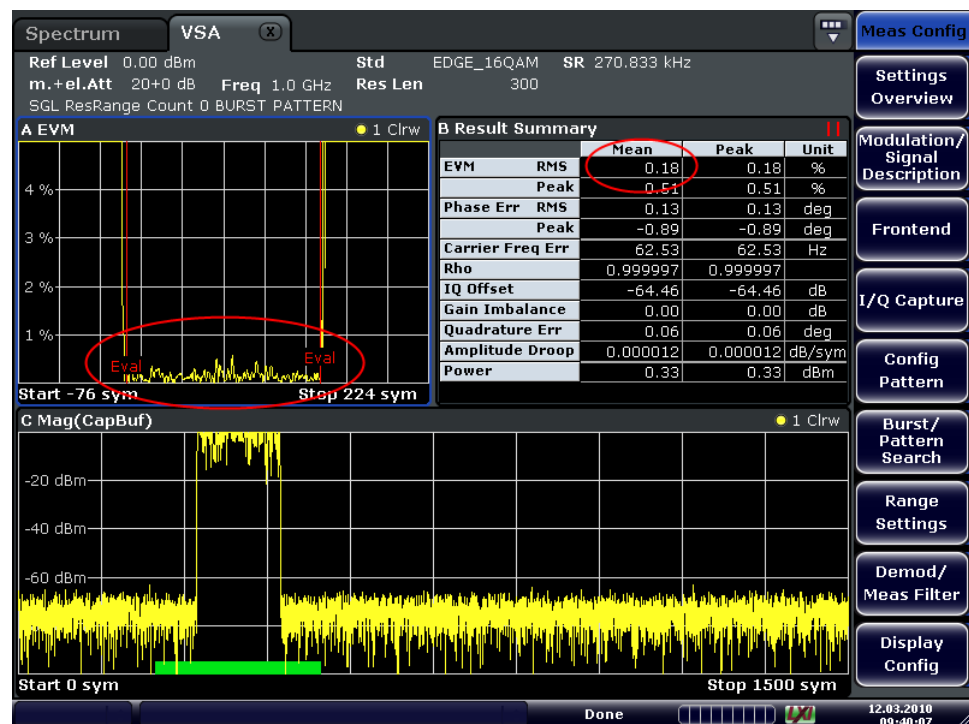
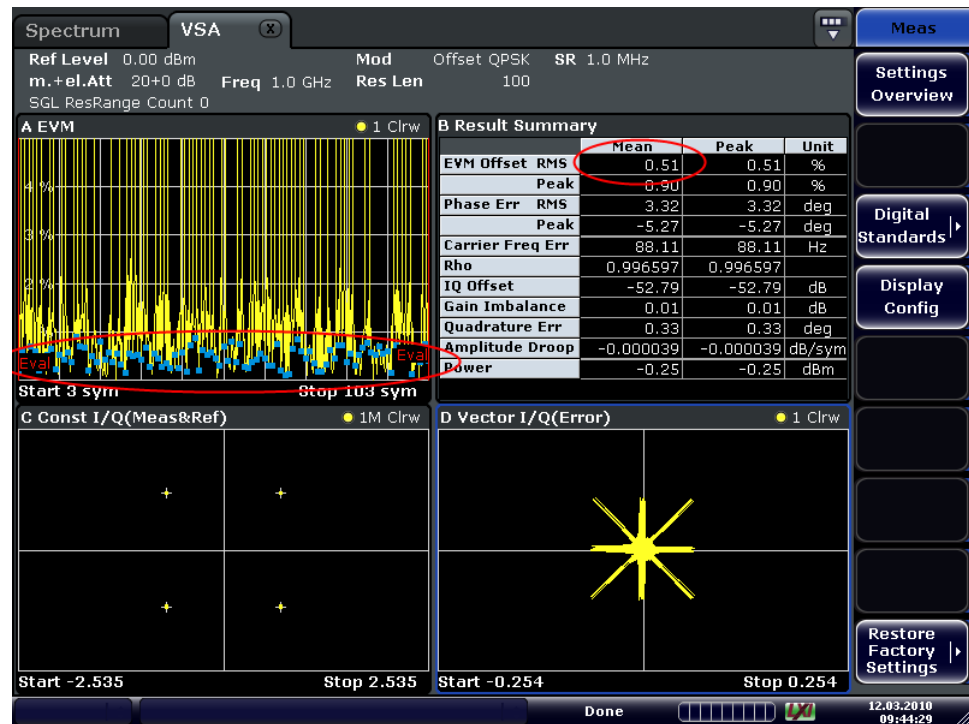


Fig. 9-13: Solution: Result Summary with correct evaluation range setting

- Make sure that the same samples are evaluated. By default, the EVM trace displays all sample instants, e.g. if the sample rate is 4, the EVM trace shows 4 samples per symbol. The Result Summary does not automatically evaluate all sample instants.

E.g. for a PSK modulation, by default only symbol instants contribute to the EVM result.

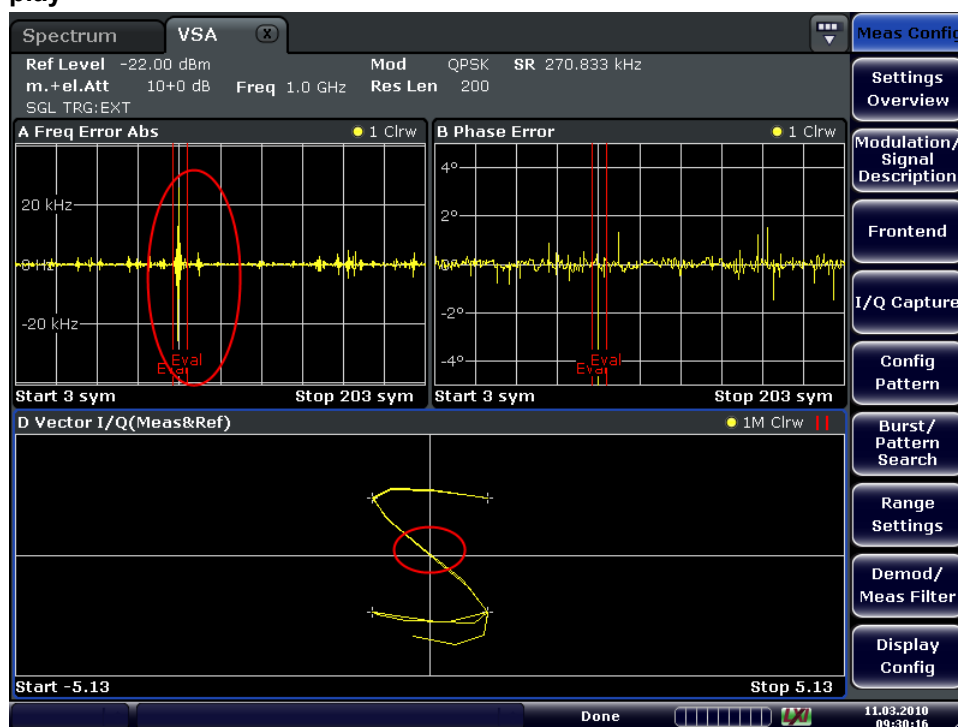


**Question: Why isn't the FSK Deviation Error in R&S FSW-K70 identical to the FSK DEV ERROR in R&S FSQ-K70?**

Solution:

The FSK deviation error in the R&S FSW-K70 is calculated as the difference between the measured frequency deviation and the reference frequency deviation as entered by the user (see "FSK Ref Deviation (FSK only)" on page 129). What is referred to as the "FSK DEV ERROR" in the R&S FSQ-K70 is calculated differently (see the R&S FSQ-K70 Software Manual) and is comparable to the "Freq Err RMS" in the R&S FSW-K70. However, while the "FSK DEV ERROR" in the R&S FSQ-K70 is given in Hz, the "Freq Err RMS" in the R&S FSW-K70 is given in percent, i.e. relative to the "FSK Meas Deviation".

### Problem: The PSK/QAM Signal shows spikes in the Frequency Error result display



Solution:

These spikes are usually uncritical and are caused by zero-transitions in the I/Q Plane.

**Question: The y-axis unit for the spectrum of the measurement signal can be chosen to be "dB". What level is this relative to?**

Answer:

Spectrum (Reallmag, Meas&Ref) calculates the FFT of the result Reallmag(Meas&Ref). Reallmag(Meas&Ref) has the unit "none". In this case, "none" means the measured signal has been scaled such that it matches the ideal corresponding reference signal as well as possible. The reference signal in turn is scaled such that  $\max(\text{abs}(a_t \text{ symbol instants})) = 1.0$ .

**Question: How can I get the demodulated symbols of all my GSM bursts in the capture buffer in remote control?**

Answer:

Use the following remote commands:

```
:SENSe1:DDEMod:PRESet 'GSM_NB'
```

Load the GSM standard.

```
:SENSe1:DDEMod:RLENgth 10000 SYM
```

Enlarge the capture buffer length such that all the bursts you want to demodulate can be seen within the capture buffer.

```
:INITiate1:CONTinuous OFF
```

Go to single sweep mode.

```
:SENSe1:SWEEp:COUNT 0
```

Set the "Statistic Count" to "Auto" mode.

```
:INITiate1:IMMediate
```

Do single sweep.

```
:SENSe1:SWEEp:COUNT:CURRENT?
```

Query the number of demodulated bursts within the capture buffer.

```
For n = 1:NumberOfBursts
```

```
    :SENSe1:DDEMod:SEARCH:MBURst:CALC n
```

```
    :TRACe4? TRACe1 'Query the result symbols in window D
```

```
End
```

Step through all bursts and query the demodulated symbols.

#### **Question: Why do the EVM results for my FSK-modulated signal look wrong?**

Answer:

For an FSK-modulated signal, the signal processing differs to an PSK/QAM/MSK-modulated signal. The estimation model does not minimize the EVM but the error of the instantaneous frequency (see [chapter 4.5.2.1, "Error Model"](#), on page 107). Therefore, the measurement value that corresponds to the EVM value for FSK is the the Frequency Error (Absolute/Relative). (Source Type: Modulation Error; Result Type: Frequency Error (Absolute/Relative))

## 9.4 Obtaining Technical Support

If problems occur, the instrument generates error messages which in most cases will be sufficient for you to detect the cause of an error and find a remedy.

Error messages are described in [chapter 9.2, "Explanation of Error Messages"](#), on page 239.

In addition, our customer support centers are there to assist you in solving any problems that you may encounter with your R&S FSW. We will find solutions more quickly and efficiently if you provide us with the information listed below.

- **System Configuration:** The "System Configuration" dialog box (in the "Setup" menu) provides information on:
  - **Hardware Info:** hardware assemblies
  - **Versions and Options:** the status of all software and hardware options installed on your instrument
  - **System Messages:** messages on any errors that may have occurred

An .xml file with information on the system configuration ("device footprint") can be created automatically.

- **Error Log:** The `RSError.log` file (in the log directory of the main installation directory) contains a chronological record of errors.
- **Support file:** a \*.zip file with important support information can be created automatically. The \*.zip file contains the system configuration information ("device footprint"), the current eeprom data and a screenshot of the screen display.

**To collect the support information**

1. Press the SETUP key.
2. Select "Service > R&S Support" and then "Create R&S Support Information".

The file is stored as `C:\R_S\instr\user\service.zip`.

Attach the support file to an e-mail in which you describe the problem and send it to the customer support address for your region as listed at the beginning of the R&S FSW Getting Started manual.



## 10 Remote Commands for VSA

The following commands are required to perform measurements in VSA in a remote environment. It assumes that the R&S FSW has already been set up for remote operation in a network as described in the base unit manual.

### Common Suffixes

In VSA, the following common suffixes are used in remote commands:

Suffix	Value range	Description
<m>	1..4	Marker
<n>	1..16	Window
<t>	1..6	Trace



Note that basic tasks that are also performed in the base unit in the same way are not described here. For a description of such tasks, see the R&S FSW User Manual.

In particular, this includes:

- Managing Settings and Results, i.e. storing and loading settings and result data
- Basic instrument configuration, e.g. checking the system configuration, customizing the screen layout, or configuring networks and remote operation
- Using the common status registers

The following tasks specific to VSA are described here:

• <a href="#">Introduction</a> .....	257
• <a href="#">Activating Vector Signal Analysis</a> .....	262
• <a href="#">Digital Standards</a> .....	265
• <a href="#">Configuring VSA</a> .....	267
• <a href="#">Performing a Measurement</a> .....	326
• <a href="#">Analysis</a> .....	332
• <a href="#">Configuring the Result Display</a> .....	349
• <a href="#">Retrieving Results</a> .....	360
• <a href="#">Status Reporting System</a> .....	378
• <a href="#">Obsolete Commands</a> .....	388
• <a href="#">Programming Examples</a> .....	390

### 10.1 Introduction

Commands are program messages that a controller (e.g. a PC) sends to the instrument or software. They operate its functions ('setting commands' or 'events') and request information ('query commands'). Some commands can only be used in one way, others work in two ways (setting and query). If not indicated otherwise, the commands can be used for settings and queries.

The syntax of a SCPI command consists of a header and, in most cases, one or more parameters. To use a command as a query, you have to append a question mark after the last header element, even if the command contains a parameter.

A header contains one or more keywords, separated by a colon. Header and parameters are separated by a "white space" (ASCII code 0 to 9, 11 to 32 decimal, e.g. blank). If there is more than one parameter for a command, these are separated by a comma from one another.

Only the most important characteristics that you need to know when working with SCPI commands are described here. For a more complete description, refer to the User Manual of the R&S FSW.



### Remote command examples

Note that some remote command examples mentioned in this general introduction may not be supported by this particular application.

---

## 10.1.1 Long and Short Form

The keywords have a long and a short form. You can use either the long or the short form, but no other abbreviations of the keywords.

The short form is emphasized in upper case letters. Note however, that this emphasis only serves the purpose to distinguish the short from the long form in the manual. For the instrument, the case does not matter.

#### Example:

`SENSe:FREQUency:CENTer` is the same as `SENS:FREQ:CENT`.

## 10.1.2 Numeric Suffixes

Some keywords have a numeric suffix if the command can be applied to multiple instances of an object. In that case, the suffix selects a particular instance (e.g. a measurement window).

Numeric suffixes are indicated by angular brackets (<n>) next to the keyword.

If you don't quote a suffix for keywords that support one, a 1 is assumed.

#### Example:

`DISPlay[:WINDow<1...4>]:ZOOM:STATe` enables the zoom in a particular measurement window, selected by the suffix at `WINDow`.

`DISPlay:WINDow4:ZOOM:STATe ON` refers to window 4.

### 10.1.3 Optional Keywords

Some keywords are optional and are only part of the syntax because of SCPI compliance. You can include them in the header or not.

Note that if an optional keyword has a numeric suffix and you need to use the suffix, you have to include the optional keyword. Otherwise, the suffix of the missing keyword is assumed to be the value 1.

Optional keywords are emphasized with square brackets.

**Example:**

Without a numeric suffix in the optional keyword:

[SENSe:]FREQuency:CENTer is the same as FREQuency:CENTer

With a numeric suffix in the optional keyword:

DISPlay[:WINDow<1...4>]:ZOOM:STATe

DISPlay:ZOOM:STATe ON enables the zoom in window 1 (no suffix).

DISPlay:WINDow4:ZOOM:STATe ON enables the zoom in window 4.

### 10.1.4 Alternative Keywords

A vertical stroke indicates alternatives for a specific keyword. You can use both keywords to the same effect.

**Example:**

[SENSe:]BANDwidth|BWIDth[:RESolution]

In the short form without optional keywords, BAND 1MHZ would have the same effect as BWID 1MHZ.

### 10.1.5 SCPI Parameters

Many commands feature one or more parameters.

If a command supports more than one parameter, these are separated by a comma.

**Example:**

LAYout:ADD:WINDow Spectrum,LEFT,MTABLE

Parameters may have different forms of values.

- [Numeric Values](#).....260
- [Boolean](#).....260
- [Character Data](#).....261
- [Character Strings](#).....261
- [Block Data](#).....261

### 10.1.5.1 Numeric Values

Numeric values can be entered in any form, i.e. with sign, decimal point or exponent. In case of physical quantities, you can also add the unit. If the unit is missing, the command uses the basic unit.

**Example:**

with unit: `SENSe:FREQuency:CENTer 1GHZ`

without unit: `SENSe:FREQuency:CENTer 1E9` would also set a frequency of 1 GHz.

Values exceeding the resolution of the instrument are rounded up or down.

If the number you have entered is not supported (e.g. in case of discrete steps), the command returns an error.

Instead of a number, you can also set numeric values with a text parameter in special cases.

- **MIN/MAX**  
Defines the minimum or maximum numeric value that is supported.
- **DEF**  
Defines the default value.
- **UP/DOWN**  
Increases or decreases the numeric value by one step. The step size depends on the setting. In some cases you can customize the step size with a corresponding command.

#### Querying numeric values

When you query numeric values, the system returns a number. In case of physical quantities, it applies the basic unit (e.g. Hz in case of frequencies). The number of digits after the decimal point depends on the type of numeric value.

**Example:**

Setting: `SENSe:FREQuency:CENTer 1GHZ`

Query: `SENSe:FREQuency:CENTer?` would return `1E9`

In some cases, numeric values may be returned as text.

- **INF/NINF**  
Infinity or negative infinity. Represents the numeric values 9.9E37 or -9.9E37.
- **NAN**  
Not a number. Represents the numeric value 9.91E37. NAN is returned in case of errors.

### 10.1.5.2 Boolean

Boolean parameters represent two states. The "ON" state (logically true) is represented by "ON" or a numeric value 1. The "OFF" state (logically untrue) is represented by "OFF" or the numeric value 0.

### Querying boolean parameters

When you query boolean parameters, the system returns either the value 1 ("ON") or the value 0 ("OFF").

#### Example:

Setting: `DISPlay:WINDow:ZOOM:STATe ON`

Query: `DISPlay:WINDow:ZOOM:STATe?` would return 1

### 10.1.5.3 Character Data

Character data follows the syntactic rules of keywords. You can enter text using a short or a long form. For more information see [chapter 10.1.1, "Long and Short Form"](#), on page 258.

### Querying text parameters

When you query text parameters, the system returns its short form.

#### Example:

Setting: `SENSe:BANDwidth:RESolution:TYPE NORMal`

Query: `SENSe:BANDwidth:RESolution:TYPE?` would return NORM

### 10.1.5.4 Character Strings

Strings are alphanumeric characters. They have to be in straight quotation marks. You can use a single quotation mark ( ' ) or a double quotation mark ( " ).

#### Example:

`INSTRument:DELeTe 'Spectrum'`

### 10.1.5.5 Block Data

Block data is a format which is suitable for the transmission of large amounts of data.

The ASCII character # introduces the data block. The next number indicates how many of the following digits describe the length of the data block. In the example the 4 following digits indicate the length to be 5168 bytes. The data bytes follow. During the transmission of these data bytes all end or other control signs are ignored until all bytes are transmitted. #0 specifies a data block of indefinite length. The use of the indefinite format requires a NL^END message to terminate the data block. This format is useful when the length of the transmission is not known or if speed or other considerations prevent segmentation of the data into blocks of definite length.

## 10.2 Activating Vector Signal Analysis

Vector signal analysis requires a special application on the R&S FSW. A measurement is started immediately with the default settings.

<code>INSTrument:CREate[:NEW]</code> .....	262
<code>INSTrument:CREate:REPLace</code> .....	262
<code>INSTrument:DELeTe</code> .....	263
<code>INSTrument:LIST?</code> .....	263
<code>INSTrument:REName</code> .....	264
<code>INSTrument[:SELeCt]</code> .....	264
<code>SYSTem:PRESet:CHANnel[:EXECute]</code> .....	264

---

### `INSTrument:CREate[:NEW]` <ChannelType>, <ChannelName>

This command adds an additional measurement channel. The number of measurement channels you can configure at the same time depends on available memory.

#### Parameters:

<ChannelType>	Channel type of the new channel. For a list of available channel types see <a href="#">table 10-1</a> .
<ChannelName>	String containing the name of the channel. The channel name is displayed as the tab label for the measurement channel. Note: If the specified name for a new channel already exists, the default name, extended by a sequential number, is used for the new channel (see <a href="#">table 10-1</a> ).

**Example:** `INST:CRE SAN, 'Spectrum 2'`  
Adds an additional spectrum display named "Spectrum 2".

---

### `INSTrument:CREate:REPLace` <ChannelName1>,<ChannelType>,<ChannelName2>

This command replaces a measurement channel with another one.

#### Parameters:

<ChannelName1>	String containing the name of the measurement channel you want to replace.
<ChannelType>	Channel type of the new channel. For a list of available channel types see <a href="#">table 10-1</a> .
<ChannelName2>	String containing the name of the new channel. Note: If the specified name for a new channel already exists, the default name, extended by a sequential number, is used for the new channel (see <a href="#">table 10-1</a> ).

**Example:** `INST:CRE:REPL 'Spectrum2', IQ, 'IQAnalyzer'`  
Replaces the channel named 'Spectrum2' by a new measurement channel of type 'IQ Analyzer' named 'IQAnalyzer'.

**INSTrument:DELeTe** <ChannelName>

This command deletes a measurement channel. If you delete the last measurement channel, the default "Spectrum" channel is activated.

**Parameters:**

<ChannelName> String containing the name of the channel you want to delete. A measurement channel must exist in order to be able delete it.

**Example:**

```
INST:DEL 'Spectrum4'
```

Deletes the spectrum channel with the name 'Spectrum4'.

**INSTrument:LIST?**

This command queries all active measurement channels. This is useful in order to obtain the names of the existing measurement channels, which are required in order to replace or delete the channels.

**Return values:**

<ChannelType>, <ChannelName> For each channel, the command returns the channel type and channel name (see [table 10-1](#)).  
Tip: to change the channel name, use the `INSTrument:REName` command.

**Example:**

```
INST:LIST?
```

Result for 3 measurement channels:  
'ADEM', 'Analog Demod', 'IQ', 'IQ Analyzer', 'SANALYZER', 'Spectrum'

**Usage:**

Query only

**Table 10-1: Available measurement channel types and default channel names**

Application	<ChannelType> Parameter	Default Channel Name*)
Spectrum	SANALYZER	Spectrum
I/Q Analyzer	IQ	IQ Analyzer
Pulse (R&S FSW-K6)	PULSE	Pulse
Analog Demodulation (R&S FSW-K7)	ADEM	Analog Demod
GSM (R&S FSW-K10)	GSM	GSM
Multi-Carrier Group Delay (R&S FSW-K17)	MCGD	MC Group Delay
Noise (R&S FSW-K30)	NOISE	Noise
Phase Noise (R&S FSW-K40)	PNOISE	Phase Noise
VSA (R&S FSW-K70)	DDEM	VSA

Note: the default channel name is also listed in the table. If the specified name for a new channel already exists, the default name, extended by a sequential number, is used for the new channel.

Application	<ChannelType> Parameter	Default Channel Name*)
3GPP FDD BTS (R&S FSW-K72)	BWCD	3G FDD BTS
3GPP FDD UE (R&S FSW-K73)	MWCD	3G FDD UE
cdma2000 BTS (R&S FSW-K82)	BC2K	CDMA2000 BTS
cdma2000 MS (R&S FSW-K83)	MC2K	CDMA2000 MS
1xEV-DO BTS (R&S FSW-K84)	BDO	1xEV-DO BTS
1xEV-DO MS (R&S FSW-K85)	MDO	1xEV-DO MS
WLAN (R&S FSW-K91)	WLAN	WLAN
LTE (R&S FSW-K10x)	LTE	LTE

Note: the default channel name is also listed in the table. If the specified name for a new channel already exists, the default name, extended by a sequential number, is used for the new channel.

---

**INSTrument:REName** <ChannelName1>, <ChannelName2>

This command renames a measurement channel.

**Parameters:**

- <ChannelName1> String containing the name of the channel you want to rename.
- <ChannelName2> String containing the new channel name.  
Note that you can not assign an existing channel name to a new channel; this will cause an error.

**Example:** `INST:REN 'Spectrum2', 'Spectrum3'`  
Renames the channel with the name 'Spectrum2' to 'Spectrum3'.

---

**INSTrument[:SElect]** <ChannelType>

Selects the application (channel type) for the current channel.

See also `INSTrument:CREate[:NEW]` on page 262.

For a list of available channel types see [table 10-1](#).

**Parameters:**

- <ChannelType> **VSA**  
VSA, R&S FSW-K70

---

**SYSTem:PRESet:CHANnel[:EXECute]**

This command restores the default instrument settings in the current channel.

Use `INST:SEL` to select the channel.



<b>Example:</b>	INST 'Spectrum2' Selects the channel for "Spectrum2". SYST:PRES:CHAN:EXEC Restores the factory default settings to the "Spectrum2" channel.
<b>Usage:</b>	Event
<b>Manual control:</b>	See <a href="#">"Preset Channel"</a> on page 125

## 10.3 Digital Standards

Various predefined settings files for common digital standards are provided for use with the VSA application. In addition, you can create your own settings files for user-specific measurements.

Manual configuration of digital standards is described in [chapter 5.2, "Configuration According to Digital Standards"](#), on page 121.

<a href="#">[SENSe:]DDEMod:FACTory[:VALue]</a> .....	265
<a href="#">[SENSe:]DDEMod:PRESet[:STANdard]</a> .....	265
<a href="#">[SENSe:]DDEMod:STANdard:COMMeNt</a> .....	266
<a href="#">[SENSe:]DDEMod:STANdard:DELeTe</a> .....	266
<a href="#">[SENSe:]DDEMod:STANdard:PRESet[:VALue]</a> .....	266
<a href="#">[SENSe:]DDEMod:STANdard:SAVE</a> .....	267

---

### **[SENSe:]DDEMod:FACTory[:VALue]** <Factory>

This command restores the factory settings of standards or patterns for the VSA application.

#### **Setting parameters:**

<Factory> ALL | STANdard | PATTeRn

#### **ALL**

Restores both standards and patterns.

\*RST: ALL

**Usage:** Setting only

**Manual control:** See ["Restore Factory Settings"](#) on page 121  
See ["Restore Standard Files"](#) on page 121  
See ["Restore Pattern Files"](#) on page 121  
See ["Digital Standards"](#) on page 122

---

### **[SENSe:]DDEMod:PRESet[:STANdard]** <Standard>

This command selects an automatic setting of all modulation parameters according to a standardized transmission method or a user-defined transmission method. The standardized transmission methods are available in the instrument as predefined standards.

**Setting parameters:**

<Standard> string  
 Specifies the file name that contains the transmission method without the extension. For user-defined standards, the file path must be included. Default standards predefined by Rohde&Schwarz do not require a path definition. A list of predefined standards (including short forms) is provided in the annex (see [chapter A.1, "Predefined Standards and Settings"](#), on page 398).

**Example:**

DDEM: PRES 'TETRA\_NDDOWN'  
 Switches the predefined digital standard "TETRA\_Discontinuous-Downlink" on.  
 DDEM: PRES 'C:\R\_S\Instr\usr\standards\USER\_GSM'  
 Switches the user-defined digital standard "USER\_GSM" on.

**Manual control:**

See ["Digital Standards"](#) on page 122  
 See ["Load Standard"](#) on page 122

**[SENSe:]DDEMod:STANdard:COMMeNt <Comment>**

This command enters the comment for a new standard. The comment is stored with the standard and is only displayed in the selection menu (manual operation). When remote control is used, the string is deleted after the standard has been stored, allowing a new comment to be entered for the next standard. In this case a blank string is returned when a query is made.

**Setting parameters:**

<Comment> string

**Manual control:**

See ["Digital Standards"](#) on page 122  
 See ["Comment"](#) on page 122

**[SENSe:]DDEMod:STANdard:DELeTe <FileName>**

This command deletes a specified digital standard file in the vector signal analysis. The file name includes the path. If the file does not exist, an error message is displayed

**Setting parameters:**

<FileName> string  
 File name including the path for the digital standard file

**Usage:** Setting only

**Manual control:**

See ["Digital Standards"](#) on page 122  
 See ["Delete Standard"](#) on page 123

**[SENSe:]DDEMod:STANdard:PREset[:VALue]**

This command restores the default settings of the currently selected standard.

**Usage:** Event

**[SENSe:]DDEMod:STANdard:SAVE <FileName>**

This command stores the current settings of the vector signal analysis as a new user-defined digital standard. If the name of the digital standard is already in use, an error message is output and a new name has to be selected. It is recommended that you define a comment before storing the standard.

**Setting parameters:**

<FileName>                    string  
                                   The path and file name to which the settings are stored.

**Example:**

```
DDEM:STAN:COMM 'GSM_AccessBurst with Pattern'
Defines a comment for the settings.
DDEM:STAN:SAVE 'C:
\R_S\Instr\usr\standards\USER_GSM'
Stores the settings in the user-defined digital standard
"USER_GSM".
```

**Usage:**                    Setting only

**Manual control:**        See ["Digital Standards"](#) on page 122  
                                   See ["Save Standard"](#) on page 123  
                                   See ["Save Standard"](#) on page 123

## 10.4 Configuring VSA

• <a href="#">Signal Description</a> .....	267
• <a href="#">Input and Frontend Settings</a> .....	279
• <a href="#">Signal Capture</a> .....	295
• <a href="#">Triggering Measurements</a> .....	297
• <a href="#">Configuring Sweeps</a> .....	303
• <a href="#">Configuring Bursts and Patterns</a> .....	304
• <a href="#">Defining the Result Range</a> .....	310
• <a href="#">Demodulation Settings</a> .....	312
• <a href="#">Measurement Filter Settings</a> .....	320
• <a href="#">Defining the Evaluation Range</a> .....	322
• <a href="#">Adjusting Settings Automatically</a> .....	323

### 10.4.1 Signal Description

The signal description provides information on the expected input signal, which optimizes pattern and burst detection and the calculation of the ideal reference signal.

Manual configuration of the signal description is described in [chapter 5.4, "Signal Description"](#), on page 126.

• <a href="#">Modulation</a> .....	268
• <a href="#">Signal Structure</a> .....	276

### 10.4.1.1 Modulation

The modulation settings vary depending on the selected modulation type; in particular, FSK modulation provides some additional settings.

CALCulate<n>:FSK:DEVIation:REFerence:RELative.....	268
CALCulate<n>:FSK:DEVIation:REFerence[:VALue].....	268
[SENSe:]DDEMod:APSK:NState.....	269
[SENSe:]DDEMod:ASK:NState.....	269
[SENSe:]DDEMod:FILTer:ALPHa.....	269
[SENSe:]DDEMod:FILTer[:STATe].....	269
[SENSe:]DDEMod:FORMat.....	270
[SENSe:]DDEMod:FSK:NState.....	270
[SENSe:]DDEMod:MAPPing:CATalog?.....	271
[SENSe:]DDEMod:MAPPing[:VALue].....	271
[SENSe:]DDEMod:MSK:FORMat.....	271
[SENSe:]DDEMod:PSK:FORMat.....	272
[SENSe:]DDEMod:PSK:NState.....	272
[SENSe:]DDEMod:QAM:FORMat.....	272
[SENSe:]DDEMod:QAM:NState.....	273
[SENSe:]DDEMod:QPSK:FORMat.....	273
[SENSe:]DDEMod:SRATe.....	274
[SENSe:]DDEMod:TFILTer:ALPHa.....	274
[SENSe:]DDEMod:TFILTer:NAME.....	275
[SENSe:]DDEMod:TFILTer[:STATe].....	275
[SENSe:]DDEMod:TFILTer:USER.....	275
[SENSe:]DDEMod:USER:NAME.....	275

---

#### CALCulate<n>:FSK:DEVIation:REFerence:RELative <FSKRefDev>

This command defines the deviation to the reference frequency for FSK modulation as a multiple of the symbol rate.

For details see "[FSK Ref Deviation \(FSK only\)](#)" on page 129.

#### Setting parameters:

<FSKRefDev>            numeric value  
                           Range:     0.1 to 15  
                           \*RST:     1  
                           Default unit: NONE

**Manual control:**     See "[FSK Ref Deviation \(FSK only\)](#)" on page 129

---

#### CALCulate<n>:FSK:DEVIation:REFerence[:VALue] <FSKRefDevAbsRes>

This command defines the deviation to the reference frequency for FSK modulation as an absolute value in Hz.

**Setting parameters:**

<FSKRefDevAbsRes>numeric value  
 Range: 10.0 to 64e9  
 \*RST: 100e3  
 Default unit: Hz

**Manual control:** See "[FSK Ref Deviation \(FSK only\)](#)" on page 129

**[SENSe:]DDEMod:APSK:NState <APSKNstate>**

This command defines the specific demodulation mode for APSK. The following APSK demodulation modes are possible: DDEMod:APSK:NState 16 16APSK 32 32APSK

**Setting parameters:**

<APSKNstate> numeric value  
 \*RST: 16

**Manual control:** See "[Modulation Order](#)" on page 128

**[SENSe:]DDEMod:ASK:NState <ASKNstate>**

This command defines the specific demodulation mode for ASK. The following ASK demodulation modes are possible: DDEMod:ASK:NState 2 OOK 4 4ASK

**Setting parameters:**

<ASKNstate> numeric value  
 \*RST: 2

**Manual control:** See "[Modulation Order](#)" on page 128

**[SENSe:]DDEMod:FILTer:ALPHa <MeasFiltAlphaBT>**

This command determines the filter characteristic (ALPHA/BT). The resolution is 0.01.

**Setting parameters:**

<MeasFiltAlphaBT> numeric value  
 Range: 0.1 to 1.0  
 \*RST: 0.22  
 Default unit: NONE

**[SENSe:]DDEMod:FILTer[:STATe] <MeasFilterState>**

This command defines whether the input signal that is evaluated is filtered by the measurement filter. This command has no effect on the transmit filter.

**Setting parameters:**

&lt;MeasFilterState&gt; ON | OFF

**ON**[\[SENSe:\]DDEMod:MFILter:AUTO](#) is activated.**OFF**The input signal is not filtered. [\[SENSe:\]DDEMod:MFILter:AUTO](#) is deactivated.

\*RST: ON

**[SENSe:]DDEMod:FORMat <Group>**

This command selects the digital demodulation mode.

**Setting parameters:**

&lt;Group&gt; MSK | PSK | QAM | QPSK | FSK | ASK | APSK | UQAM

**QPSK**

Quad Phase Shift Key

**PSK**

Phase Shift Key

**MSK**

Minimum Shift Key

**QAM**

Quadrature Amplitude Modulation

**FSK**

Frequency Shift Key

**ASK**

Amplitude Shift Keying

**APSK**

Amplitude Phase Shift Keying

**UQAM**User-defined modulation (loaded from file, see [\[SENSe:\]DDEMod:USER:NAME](#) on page 275)

\*RST: PSK

**Example:**

SENS:DDEM:FORM QAM

**Manual control:**See "[Modulation Type](#)" on page 127See "[Load User Modulation](#)" on page 128**[SENSe:]DDEMod:FSK:NState <FSKNstate>**

This command defines the demodulation of the FSK modulation scheme.

**Setting parameters:**

<FSKNstate> 2 | 4 | 8  
 2  
 2FSK  
 4  
 4FSK  
 8  
 8FSK  
 \*RST: 2

**Manual control:** See "[Modulation Order](#)" on page 128

**[SENSe:]DDEMod:MAPPING:CATalog?**

This command queries the names of all mappings that are available for the current modulation type and order. A mapping describes the assignment of constellation points to symbols.

**Return values:**

<Mappings> A comma-separated list of strings, with one string for each mapping name.

**Example:**

:SENSe:DDEMod:MAPPING:CATalog?

Result:

'CDMA2K\_FWD', 'DVB\_S2', 'GRAY', 'NATURAL', 'WCDMA'

**Usage:**

Query only

**Manual control:** See "[Modulation Mapping](#)" on page 129

**[SENSe:]DDEMod:MAPPING[:VALue] <Mapping>**

To obtain a list of available symbol mappings for the current modulation type use the [\[SENSe:\]DDEMod:MAPPING:CATalog??](#) query.

**Setting parameters:**

<Mapping> string

**Example:**

SENS:DDEM:MAPP 'GSM'

Sets mapping to GSM.

**Manual control:** See "[Modulation Mapping](#)" on page 129

**[SENSe:]DDEMod:MSK:FORMat <Name>**

This command defines the specific demodulation mode for MSK.

**Setting parameters:**

<Name> TYPE1 | TYPE2 | NORMAl | DIFFerential  
**TYPE1 | NORMAl**  
 MSK  
**TYPE2 | DIFFerential**  
 DMSK  
 \*RST: QPSK

**Manual control:** See "[Modulation Order](#)" on page 128

**[SENSe:]DDEMod:PSK:FORMat <Name>**

Together with DDEMod:PSK:NST, this command defines the demodulation order for PSK (see also [\[SENSe:\]DDEMod:PSK:NSTate](#) on page 272). Depending on the demodulation format and state, the following orders are available:

NSTATE	<Name>	Order
2	any	BPSK
8	NORMAl	8PSK
8	DIFFerential	D8PSK
8	N3Pi8	3pi/8-8PSK (EDGE)
8	PI8D8PSK	Pi/8-D8PSK

**Setting parameters:**

<Name> NORMAl | DIFFerential | N3Pi8 | PI8D8PSK  
 \*RST: QPSK

**Manual control:** See "[Modulation Order](#)" on page 128

**[SENSe:]DDEMod:PSK:NSTate <PSKNstate>**

Together with DDEMod:PSK:FORMat, this command defines the demodulation order for PSK (see also [\[SENSe:\]DDEMod:PSK:FORMat](#) on page 272).

**Setting parameters:**

<PSKNstate> 2 | 8  
 \*RST: 2

**Manual control:** See "[Modulation Order](#)" on page 128

**[SENSe:]DDEMod:QAM:FORMat <Name>**

This command defines the specific demodulation mode for QAM.



**Setting parameters:**

<Name>            NORMal | DIFFerential | NPI4 | MNPI4

**NORMal**  
QAM

**DIFFerential**  
DQAM

**NPI4**  
 $\pi/4$ -16QAM

**MNPI4**  
 $-\pi/4$ -32QAM

\*RST:            QPSK

**Manual control:**    See "[Modulation Order](#)" on page 128

**[SENSe:]DDEMod:QAM:NState <QAMNState>**

This command defines the demodulation order for QAM.

<QAMNState>	Order
16	16QAM
16	Pi/4-16QAM
32	32QAM
32	Pi/4-32QAM
64	64QAM
128	128QAM
256	256QAM

**Setting parameters:**

<QAMNState>        numeric value

\*RST:            16

**Manual control:**    See "[Modulation Order](#)" on page 128

**[SENSe:]DDEMod:QPSK:FORMat <Name>**

This command defines the demodulation order for QPSK.

**Setting parameters:**

<Name> NORMAl | DIFFerential | NPI4 | DPI4 | OFFSet | N3PI4

**NORMAl**

QPSK

**DIFFerential**

DQPSK

**NPI4**

$\pi/4$  QPSK

**DPI4**

$\pi/4$  DQPSK

**OFFSet**

OQPSK

**N3PI4**

$3\pi/4$  QPSK

\*RST: NORMAl

**Example:**

DDEM:FORM QPSK

Switches QPSK demodulation on.

DDEM:QPSK:FORM DPI4

Switches  $\pi/4$  DQPSK demodulation on.

**Manual control:**

See "[Modulation Order](#)" on page 128

**[SENSe:]DDEMod:SRATe** <SymbolRate>

This command defines the symbol rate.

The minimum symbol rate is 25 Hz. The maximum symbol rate depends on the defined [Sample Rate](#) (see [chapter 4.2, "Sample Rate, Symbol Rate and I/Q Bandwidth"](#), on page 57).

**Setting parameters:**

<SymbolRate> numeric value

Range: 25 to 250e6

\*RST: 3.84e6

Default unit: Hz

**Manual control:**

See "[Symbol Rate](#)" on page 129

**[SENSe:]DDEMod:TFILter:ALPHa** <Alpha>

This command determines the filter characteristic (ALPHA/BT). The resolution is 0.01.

**Setting parameters:**

<Alpha> numeric value

Range: 0.1 to 1.0

\*RST: 0.22

Default unit: NONE

**Manual control:** See ["Alpha/BT"](#) on page 130  
 See ["Type"](#) on page 180  
 See ["Alpha/BT"](#) on page 181

---

**[SENSe:]DDEMod:TFILter:NAME <Name>**

This command selects a transmit filter and automatically switches it on.

For more information on transmit filters, refer to [chapter A.2.1, "Transmit Filters"](#), on page 404.

**Setting parameters:**

<Name> string  
 Name of the Transmit filter; an overview of available transmit filters is provided in [chapter A.2.1, "Transmit Filters"](#), on page 404.

**Manual control:** See ["Transmit Filter Type"](#) on page 130  
 See ["Load User Filter"](#) on page 130

---

**[SENSe:]DDEMod:TFILter[:STATe] <TXFilterState>**

Use this command to switch the transmit filter off. To switch a transmit filter on, use the [\[SENSe:\]DDEMod:TFILter:NAME](#) command.

**Setting parameters:**

<TXFilterState> ON | OFF  
**OFF**  
 Switches the transmit filter off.  
**ON**  
 Switches the transmit filter specified by [\[SENSe:\]DDEMod:TFILter:NAME](#) on. However, this command is not necessary, as the [\[SENSe:\]DDEMod:TFILter:NAME](#) command automatically switches the filter on.  
 \*RST: ON

**Manual control:** See ["Transmit Filter Type"](#) on page 130

---

**[SENSe:]DDEMod:TFILter:USER <FilterName>**

This command selects a user-defined transmit filter file.

**Setting parameters:**

<FilterName> The name of the transmit filter file.

**Manual control:** See ["Transmit Filter Type"](#) on page 130  
 See ["Load User Filter"](#) on page 130

---

**[SENSe:]DDEMod:USER:NAME <Name>**

Selects the file that contains the user-defined modulation to be loaded.

**Setting parameters:**

<Name> string  
Path and file name of the \*.vam file

**Example:**

```
SENS:DDEM:FORM UQAM
Define the use of a user-defined modulation
SENS:DDEM:USER:NAME 'D:\MyModulation.vam'
Select the file name to be loaded
```

**Manual control:**

See "Modulation Type" on page 127  
See "Load User Modulation" on page 128

**10.4.1.2 Signal Structure**

The signal structure commands describe the expected input signal and determine which settings are available for configuration. You can define a pattern to which the instrument can be synchronized, thus adapting the result range.

[SENSe:]DDEMod:SEARch:BURSt:LENGth:MAXimum.....	276
[SENSe:]DDEMod:SEARch:BURSt:LENGth[:MINimum].....	276
[SENSe:]DDEMod:SEARch:BURSt:SKIP:FALLing.....	277
[SENSe:]DDEMod:SEARch:BURSt:SKIP:RISing.....	277
[SENSe:]DDEMod:SEARch:SYNC:CATalog.....	277
[SENSe:]DDEMod:SIGNal:PATTern.....	278
[SENSe:]DDEMod:SIGNal[:VALue].....	278
[SENSe:]DDEMod:STANdard:SYNC:OFFSet:STATe.....	278
[SENSe:]DDEMod:STANdard:SYNC:OFFSet[:VALue].....	278

**[SENSe:]DDEMod:SEARch:BURSt:LENGth:MAXimum <MaxLength>**

This command defines the maximum length of a burst. Only those bursts will be recognized that fall below this length. The default unit is symbols. The value can also be given in seconds.

**Setting parameters:**

<MaxLength> numeric value  
Range: 0 to 15000  
\*RST: 1600  
Default unit: SYM

**Manual control:**

See "Burst Settings" on page 132  
See "Min Length / Max Length" on page 132

**[SENSe:]DDEMod:SEARch:BURSt:LENGth[:MINimum] <UsefulLength>**

This command defines the minimum length of a burst. Only those bursts will be recognized that exceed this length. The default unit is symbols. The value can also be given in seconds.

**Setting parameters:**

<UsefulLength> numeric value  
 Range: 10 to 15000  
 \*RST: 98  
 Default unit: SYM

**Manual control:** See "[Burst Settings](#)" on page 132  
 See "[Min Length / Max Length](#)" on page 132

**[SENSe:]DDEMod:SEARch:BURSt:SKIP:FALLing <RunOut>**

This command defines the length of the falling burst edge which is not considered when evaluating the result. The default unit is symbols. The value can also be given in seconds.

**Setting parameters:**

<RunOut> numeric value  
 Range: 0 to 15000  
 \*RST: 1  
 Default unit: SYM

**Manual control:** See "[Burst Settings](#)" on page 132  
 See "[Run-Out](#)" on page 132

**[SENSe:]DDEMod:SEARch:BURSt:SKIP:RISing <RunIn>**

This command defines the length of the rising burst edge which was not considered when evaluating the result. The default unit is symbols. The value can also be given in seconds.

**Setting parameters:**

<RunIn> numeric value  
 Range: 0 to 15000  
 \*RST: 1  
 Default unit: SYM

**Manual control:** See "[Burst Settings](#)" on page 132  
 See "[Run-In](#)" on page 132

**[SENSe:]DDEMod:SEARch:SYNC:CATalog <Patterns>**

This command reads the names of all patterns stored on the hard disk. The file names are returned as a comma-separated list of strings, one for each file name (without the file extension).

**Setting parameters:**

<Patterns> CURRENT | ALL  
**CURRENT**  
 Only patterns that belong to the current standard  
**ALL**  
 All patterns  
 \*RST: ALL

**Example:**                   :DDEM:SEAR:SYNC:CAT? CURR  
**Result:**  
 'GSM\_AB0', 'GSM\_AB1', 'GSM\_AB2', 'GSM\_TSC1'

#### [SENSe:]DDEMod:SIGNal:PATtern <PatternedSignal>

This command specifies whether the signal contains a pattern or not.

##### Setting parameters:

<PatternedSignal>   ON | OFF  
 \*RST:            OFF

**Manual control:**    See "[Pattern Settings](#)" on page 132  
 See "[Name](#)" on page 132

#### [SENSe:]DDEMod:SIGNal[:VALue] <SignalType>

This command specifies whether the signal is bursted or continuous.

##### Setting parameters:

<SignalType>        CONTInuous | BURSted  
 \*RST:            CONTInuous

**Manual control:**    See "[Signal Type](#)" on page 132

#### [SENSe:]DDEMod:STANdard:SYNC:OFFSet:STATe < PattOffsState>

This command (de)activates the pattern offset.

##### Setting parameters:

<PattOffsState>    ON | OFF  
 \*RST:            OFF

**Manual control:**    See "[Pattern Settings](#)" on page 132  
 See "[Offset](#)" on page 133

#### [SENSe:]DDEMod:STANdard:SYNC:OFFSet[:VALue] <PatternOffset>

This command defines a number of symbols which are ignored before the comparison with the pattern starts.

##### Setting parameters:

<PatternOffset>    numeric value  
 Range:            0 to 15000  
 \*RST:            0  
 Default unit: SYM

**Manual control:**    See "[Pattern Settings](#)" on page 132  
 See "[Offset](#)" on page 133

## 10.4.2 Input and Frontend Settings

The R&S FSW can analyze signals from different input sources. The frequency and amplitude settings represent the "frontend" of the measurement setup.

Manual configuration of the input and frontend is described in [chapter 5.5, "Input and Frontend Settings"](#), on page 134.

• RF Input.....	279
• Configuring Digital I/Q Input and Output.....	281
• Frequency.....	284
• Amplitude Settings.....	286
• Configuring the Attenuation.....	288
• Scaling and Units.....	290

### 10.4.2.1 RF Input

INPut:ATTenuation:PROTection:RESet .....	279
INPut:COUPling.....	279
INPut:FILTer:HPASs[:STATe].....	280
INPut:FILTer:YIG[:STATe].....	280
INPut:SELEct.....	280

---

#### INPut:ATTenuation:PROTection:RESet

This command resets the attenuator and reconnects the RF input with the input mixer after an overload condition occurred and the protection mechanism intervened. The error status bit (bit 3 in the `STAT:QUES:POW` status register) and the `INPUT OVLD` message in the status bar are cleared.

(For details on the status register see the R&S FSW User Manual).

The command works only if the overload condition has been eliminated first.

**Usage:**                      Event

---

#### INPut:COUPling <CouplingType>

This command selects the coupling type of the RF input.

The command is not available for measurements with the Digital Baseband Interface (R&S FSW-B17).

**Parameters:**

<CouplingType>	<b>AC</b>
	AC coupling
	<b>DC</b>
	DC coupling
	*RST:      AC

**Example:**                      INP:COUP:DC

**Usage:**                        SCPI confirmed

**Manual control:** See ["Input Coupling"](#) on page 135  
See ["Input Settings"](#) on page 145

---

#### **INPut:FILTer:HPASs[:STATe]** <State>

Activates an additional internal high-pass filter for RF input signals from 1 GHz to 3 GHz. This filter is used to remove the harmonics of the R&S FSW in order to measure the harmonics for a DUT, for example.

This function requires option R&S FSW-B13.

(Note: for RF input signals outside the specified range, the high-pass filter has no effect. For signals with a frequency of approximately 4 GHz upwards, the harmonics are suppressed sufficiently by the YIG filter.)

#### **Parameters:**

<State> ON | OFF  
\*RST: OFF

**Usage:** SCPI confirmed

**Manual control:** See ["High-Pass Filter 1...3 GHz"](#) on page 135

---

#### **INPut:FILTer:YIG[:STATe]** <State>

This command turns the YIG-preselector on and off.

Note the special conditions and restrictions for the YIG filter described in ["YIG-Preselector"](#) on page 136.

#### **Parameters:**

<State> ON | OFF  
\*RST: ON (OFF for I/Q Analyzer, GSM and MC Group Delay measurements)

**Example:** INP:FILT:YIG OFF  
Deactivates the YIG-preselector.

**Manual control:** See ["YIG-Preselector"](#) on page 136

---

#### **INPut:SELEct** <Source>

This command selects the signal source for measurements, i.e. it defines which connector is used to input data to the R&S FSW. If no additional options are installed, only RF input is supported.



**Parameters:**

&lt;Source&gt;

**RF**

Radio Frequency ("RF INPUT" connector)

**DIQ**

Digital IQ data (only available with optional Digital Baseband Interface R&amp;S FSW-B17)

For details on I/Q input see the R&amp;S FSW I/Q Analyzer User Manual.

**\*RST:** RF**Manual control:**

See "Radio Frequency State" on page 135

See "Digital I/Q Input State" on page 137

**10.4.2.2 Configuring Digital I/Q Input and Output**

Useful commands for digital I/Q data described elsewhere:

- `TRIG:SEQ:LEV:BBP`**TRIGger** [`:SEQuence`] :`LEVel`:`BBPower` on page 300

**Remote commands for the R&S DigIConf software**

Remote commands for the R&S DigIConf software always begin with `SOURce:EBOX`. Such commands are passed on from the R&S FSW to the R&S DigIConf automatically which then configures the R&S EX-IQ-BOX via the USB connection.

All remote commands available for configuration via the R&S DigIConf software are described in the "R&S®EX-IQ-BOX Digital Interface Module R&S®DigIConf Software Operating Manual".

**Example 1:**`SOURce:EBOX:*RST``SOURce:EBOX:*IDN?`**Result:**`"Rohde&Schwarz,DigIConf,02.05.436 Build 47"`**Example 2:**`SOURce:EBOX:USER:CLOCK:REference:FREQuency 5MHZ`

Defines the frequency value of the reference clock.

**Remote commands exclusive to digital I/Q data input and output**

<code>INPut:DIQ:CDEvice</code> .....	282
<code>INPut:DIQ:RANGe:AUTO</code> .....	283
<code>INPut:DIQ:RANGe:COUPling</code> .....	283
<code>INPut:DIQ:RANGe[:UPPer]</code> .....	283
<code>INPut:DIQ:RANGe[:UPPer]:UNIT</code> .....	284
<code>INPut:DIQ:SRATe</code> .....	284
<code>INPut:DIQ:SRATe:AUTO</code> .....	284

**INPut:DIQ:CDEvice**

This command queries the current configuration and the status of the digital I/Q input from the optional Digital Baseband Interface (R&S FSW-B17).

For details see the section "Interface Status Information" for the Digital Baseband Interface (R&S FSW-B17) in the R&S FSW I/Q Analyzer User Manual.

**Return values:**

<ConnState>	Defines whether a device is connected or not. <b>0</b> No device is connected. <b>1</b> A device is connected.
<DeviceName>	Device ID of the connected device
<SerialNumber>	Serial number of the connected device
<PortName>	Port name used by the connected device
<SampleRate>	Maximum or currently used sample rate of the connected device in Hz (depends on the used connection protocol version; indicated by <SampleRateType> parameter)
<MaxTransferRate>	Maximum data transfer rate of the connected device in Hz
<ConnProtState>	State of the connection protocol which is used to identify the connected device. <b>Not Started</b> <b>Has to be Started</b> <b>Started</b> <b>Passed</b> <b>Failed</b> <b>Done</b>
<PRBSTestState>	State of the PRBS test. <b>Not Started</b> <b>Has to be Started</b> <b>Started</b> <b>Passed</b> <b>Failed</b> <b>Done</b>
<SampleRateType>	<b>0</b> Maximum sampling rate is displayed <b>1</b> Current sampling rate is displayed
<FullScaleLevel>	The level (in dBm) that should correspond to an I/Q sample with the magnitude "1" (if transferred from connected device); If not available, $9.97e37$ is returned

**Example:** `INP:DIQ:CDEV?`  
**Result:**  
`1,SMU200A,103634,Out`  
`A,70000000,100000000,Passed,Not Started,0,0`

**Manual control:** See ["Connected Instrument"](#) on page 138

#### **INPut:DIQ:RANGe:AUTO <State>**

If enabled, the digital input full scale level is automatically set to the value provided by the connected device (if available).

This command is only available if the optional Digital Baseband interface (option R&S FSW-B17) is installed.

**Parameters:**

<State> ON | OFF  
 \*RST: OFF

**Manual control:** See ["Full Scale Level"](#) on page 137

#### **INPut:DIQ:RANGe:COUPling <State>**

If enabled, the reference level for digital input is adjusted to the full scale level automatically if the full scale level changes.

This command is only available if the optional Digital Baseband Interface (R&S FSW-B17) is installed.

**Parameters:**

<State> ON | OFF  
 \*RST: OFF

**Manual control:** See ["Adjust Reference Level to Full Scale Level"](#) on page 138

#### **INPut:DIQ:RANGe[:UPPer] <Level>**

Defines or queries the "Full Scale Level", i.e. the level that corresponds to an I/Q sample with the magnitude "1".

This command is only available if the optional Digital Baseband Interface (R&S FSW-B17) is installed.

**Parameters:**

<Level> <numeric value>  
 Range: 1  $\mu$ V to 7.071 V  
 \*RST: 1 V

**Manual control:** See ["Full Scale Level"](#) on page 137

**INPut:DIQ:RANGe[:UPPer]:UNIT <Unit>**

Defines the unit of the full scale level (see "Full Scale Level" on page 137). The availability of units depends on the measurement application you are using.

This command is only available if the optional Digital Baseband Interface (R&S FSW-B17) is installed.

**Parameters:**

<Level> VOLT | DBM | DBPW | WATT | DBMV | DBUV | DBUA | AMPere  
\*RST: Volt

**Manual control:** See "Full Scale Level" on page 137

**INPut:DIQ:SRATe <SampleRate>**

This command specifies or queries the sample rate of the input signal from the Digital Baseband Interface (R&S FSW-B17, see "Input Sample Rate" on page 137).

**Note:** the final user sample rate of the R&S FSW may differ and is defined using SENS:DEM:PRAT (see [SENSe:]DDEMod:PRATe on page 296).

**Parameters:**

<SampleRate> Range: 1 Hz to 10 GHz  
\*RST: 32 MHz

**Example:** INP:DIQ:SRAT 200 MHz

**Manual control:** See "Input Sample Rate" on page 137

**INPut:DIQ:SRATe:AUTO <State>**

If enabled, the sample rate of the digital I/Q input signal is set automatically by the connected device.

This command is only available if the optional Digital Baseband Interface (R&S FSW-B17) is installed.

**Parameters:**

<State> ON | OFF  
\*RST: OFF

**Manual control:** See "Input Sample Rate" on page 137

**10.4.2.3 Frequency**

[SENSe:]FREQuency:CENTer.....	285
[SENSe:]FREQuency:CENTer:STEP.....	285
[SENSe:]FREQuency:CENTer:STEP:AUTO.....	285
[SENSe:]FREQuency:OFFSet.....	286

**[SENSe:]FREQuency:CENTer <Frequency>**

This command defines the center frequency.

**Parameters:**

<Frequency> The allowed range and  $f_{\max}$  is specified in the data sheet.

**UP**

Increases the center frequency by the step defined using the [\[SENSe:\]FREQuency:CENTer:STEP](#) command.

**DOWN**

Decreases the center frequency by the step defined using the [\[SENSe:\]FREQuency:CENTer:STEP](#) command.

\*RST:  $f_{\max}/2$

Default unit: Hz

**Example:**

```
FREQ:CENT 100 MHz
FREQ:CENT:STEP 10 MHz
FREQ:CENT UP
Sets the center frequency to 110 MHz.
```

**Usage:** SCPI confirmed

**Manual control:** See "[Center](#)" on page 139

**[SENSe:]FREQuency:CENTer:STEP <StepSize>**

This command defines the center frequency step size.

You can increase or decrease the center frequency quickly in fixed steps using the `SENS:FREQ UP AND SENS:FREQ DOWN` commands, see [\[SENSe:\]FREQuency:CENTer](#) on page 285.

**Parameters:**

<StepSize>  $f_{\max}$  is specified in the data sheet.

Range: 1 to fMAX

\*RST: 0.1 x span

Default unit: Hz

**Example:**

```
FREQ:CENT 100 MHz
FREQ:CENT:STEP 10 MHz
FREQ:CENT UP
Sets the center frequency to 110 MHz.
```

**Manual control:** See "[Center Frequency Stepsize](#)" on page 142

**[SENSe:]FREQuency:CENTer:STEP:AUTO <LinkMode>**

Defines the step width of the center frequency.

**Setting parameters:**

<LinkMode> ON | OFF

**ON**  
Links the step width to the current standard (currently 1 MHz for all standards)

**OFF**  
Sets the step width as defined using the `FREQ:CENT:STEP` command (see `[SENSe:]FREQuency:CENTer:STEP` on page 285).

\*RST: ON

**Manual control:** See "[Center Frequency Stepsize](#)" on page 142

**[SENSe:]FREQuency:OFFSet <Offset>**

This command defines a frequency offset.

If this value is not 0 Hz, the application assumes that the input signal was frequency shifted outside the application. All results of type "frequency" will be corrected for this shift numerically by the application.

See also "[Frequency Offset](#)" on page 142.

**Parameters:**

<Offset> Range: -100 GHz to 100 GHz  
\*RST: 0 Hz

**Example:** `FREQ:OFFS 1GHZ`

**Usage:** SCPI confirmed

**Manual control:** See "[Frequency Offset](#)" on page 142

**10.4.2.4 Amplitude Settings**

Amplitude and scaling settings allow you to configure the vertical (y-)axis display and for some result displays also the horizontal (x-)axis.

Useful commands for amplitude settings described elsewhere:

- `INPut:COUPling` on page 279
- `[SENSe:]ADJust:LEVel` on page 326

**Remote commands exclusive to amplitude settings:**

<code>DISPlay[:WINDow&lt;n&gt;]:TRACe:Y[:SCALe]:RLEVel</code> .....	286
<code>DISPlay[:WINDow&lt;n&gt;]:TRACe:Y[:SCALe]:RLEVel:OFFSet</code> .....	287
<code>[SENSe:]DDEMod:PRESet:RLEVel</code> .....	287
<code>INPut:GAIN[:VALue]</code> .....	287
<code>INPut:GAIN:STATe</code> .....	288

**DISPlay[:WINDow<n>]:TRACe:Y[:SCALe]:RLEVel <ReferenceLevel>**

This command defines the reference level.

With a reference level offset  $\neq 0$ , the value range of the reference level is modified by the offset.

**Parameters:**

<ReferenceLevel> The unit is variable.  
 Range: see datasheet  
 \*RST: 0 dBm

**Example:** DISP:TRAC:Y:RLEV -60dBm

**Usage:** SCPI confirmed

**Manual control:** See ["Reference Level"](#) on page 139

**DISPlay[:WINDow<n>]:TRACe:Y[:SCALE]:RLEVel:OFFSet <Offset>**

This command defines a reference level offset.

**Parameters:**

<Offset> Range: -200 dB to 200 dB  
 \*RST: 0dB

**Example:** DISP:TRAC:Y:RLEV:OFFS -10dB

**Manual control:** See ["Reference Level"](#) on page 139  
 See ["Shifting the Display \(Offset\)"](#) on page 140

**[SENSe:]DDEMod:PRESet:RLEVel**

This command initiates a measurement that evaluates and sets the ideal reference level for the current measurement. This ensures that the settings of the RF attenuation and the reference level are optimally adjusted to the signal level without overloading the R&S FSW or limiting the dynamic range by an S/N ratio that is too small.

**Usage:** Event

**INPut:GAIN[:VALue] <Gain>**

This command selects the preamplification level if the preamplifier is activated (INP:GAIN:STAT ON, see [INPut:GAIN:STATe](#) on page 288).

The command requires option R&S FSW-B24.

**Parameters:**

<Gain> 15 dB | 30 dB  
 The availability of preamplification levels depends on the R&S FSW model.

- R&S FSW8: 15dB and 30 dB
- R&S FSW13: 15dB and 30 dB
- R&S FSW26: 30 dB

All other values are rounded to the nearest of these two.  
 \*RST: OFF

<b>Example:</b>	INP:GAIN:VAL 30 Switches on 30 dB preamplification.
<b>Usage:</b>	SCPI confirmed
<b>Manual control:</b>	See " <a href="#">Preamplifier (option B24)</a> " on page 136 See " <a href="#">Input Settings</a> " on page 145

**INPut:GAIN:STATe** <State>

This command turns the preamplifier on and off.

The command requires option R&S FSW-B24.

This function is not available for input from the Digital Baseband Interface (R&S FSW-B17).

**Parameters:**

<State> ON | OFF  
\*RST: OFF

**Example:** INP:GAIN:STAT ON  
Switches on 30 dB preamplification.

**Usage:** SCPI confirmed

**Manual control:** See "[Preamplifier \(option B24\)](#)" on page 136  
See "[Input Settings](#)" on page 145

**10.4.2.5 Configuring the Attenuation**

INPut:ATTenuation.....	288
INPut:ATTenuation:AUTO.....	289
INPut:EATT.....	289
INPut:EATT:AUTO.....	290
INPut:EATT:STATe.....	290

**INPut:ATTenuation** <Attenuation>

This command defines the total attenuation for RF input.

If an electronic attenuator is available and active, the command defines a mechanical attenuation (see [INPut:EATT:STATe](#) on page 290).

If you set the attenuation manually, it is no longer coupled to the reference level, but the reference level is coupled to the attenuation. Thus, if the current reference level is not compatible with an attenuation that has been set manually, the command also adjusts the reference level.

This function is not available if the Digital Baseband Interface (R&S FSW-B17) is active.

**Parameters:**

<Attenuation> Range: see data sheet  
Increment: 5 dB  
\*RST: 10 dB (AUTO is set to ON)



<b>Example:</b>	INP:ATT 30dB Defines a 30 dB attenuation and decouples the attenuation from the reference level.
<b>Usage:</b>	SCPI confirmed
<b>Manual control:</b>	See " <a href="#">RF Attenuation</a> " on page 140 See " <a href="#">Attenuation Mode / Value</a> " on page 140 See " <a href="#">RF Attenuation</a> " on page 145

**INPut:ATTenuation:AUTO** <State>

This command couples or decouples the attenuation to the reference level. Thus, when the reference level is changed, the R&S FSW determines the signal level for optimal internal data processing and sets the required attenuation accordingly.

This function is not available if the Digital Baseband Interface (R&S FSW-B17) is active.

**Parameters:**

<State> ON | OFF  
\*RST: ON

<b>Example:</b>	INP:ATT:AUTO ON Couples the attenuation to the reference level.
<b>Usage:</b>	SCPI confirmed
<b>Manual control:</b>	See " <a href="#">RF Attenuation</a> " on page 140 See " <a href="#">Attenuation Mode / Value</a> " on page 140 See " <a href="#">RF Attenuation</a> " on page 145

**INPut:EATT** <Attenuation>

This command defines an electronic attenuation manually. Automatic mode must be switched off (INP:EATT:AUTO OFF, see [INPut:EATT:AUTO](#) on page 290).

If the current reference level is not compatible with an attenuation that has been set manually, the command also adjusts the reference level.

This command is only available with option R&S FSW-B25.

It is not available if R&S FSW-B17 is active.

**Parameters:**

<Attenuation> attenuation in dB  
Range: see data sheet  
Increment: 1 dB  
\*RST: 0 dB (OFF)

<b>Example:</b>	INP:EATT:AUTO OFF INP:EATT 10 dB
<b>Manual control:</b>	See " <a href="#">Using Electronic Attenuation (Option B25)</a> " on page 141

**INPut:EATT:AUTO <State>**

This command turns automatic selection of the electronic attenuation on and off.

If on, electronic attenuation reduces the mechanical attenuation whenever possible.

This command is only available with option R&S FSW-B25.

It is not available if R&S FSW-B17 is active.

**Parameters:**

<State>                    ON | OFF  
\*RST:                    ON

**Example:**                    INP:EATT:AUTO OFF

**Manual control:**            See ["Using Electronic Attenuation \(Option B25\)"](#) on page 141

**INPut:EATT:STATe <State>**

This command turns the electronic attenuator on and off.

This command is only available with option R&S FSW-B25.

It is not available if R&S FSW-B17 is active.

**Parameters:**

<State>                    ON | OFF  
\*RST:                    OFF

**Example:**                    INP:EATT:STAT ON  
Switches the electronic attenuator into the signal path.

**Manual control:**            See ["Using Electronic Attenuation \(Option B25\)"](#) on page 141

**10.4.2.6 Scaling and Units**

Useful commands for scaling described elsewhere:

- [DISPlay\[:WINDow<n>\]:TRACe:Y\[:SCALe\]:AUTO ONCE](#) on page 324
- [DISPlay\[:WINDow<n>\]:TRACe<t>:X\[:SCALe\]:VOFFset](#) on page 312

**Remote commands exclusive to scaling and units:**

<a href="#">CALCulate&lt;n&gt;:STATistics:PRESet</a> .....	291
<a href="#">CALCulate&lt;n&gt;:STATistics:SCALe:AUTO ONCE</a> .....	291
<a href="#">CALCulate&lt;n&gt;:STATistics:SCALe:X:BCOunt</a> .....	291
<a href="#">CALCulate&lt;n&gt;:STATistics:SCALe:Y:LOWer</a> .....	292
<a href="#">CALCulate&lt;n&gt;:STATistics:SCALe:Y:UPPer</a> .....	292
<a href="#">CALCulate&lt;n&gt;:STATistics:SCALe:Y:UNIT</a> .....	292
<a href="#">CALCulate&lt;n&gt;:UNIT:ANGLE</a> .....	292
<a href="#">CALCulate&lt;n&gt;:X:UNIT:TIME</a> .....	292
<a href="#">DISPlay[:WINDow&lt;n&gt;]:TRACe&lt;t&gt;:X[:SCALe]:PDIVision</a> .....	293
<a href="#">DISPlay[:WINDow&lt;n&gt;]:TRACe&lt;t&gt;:X[:SCALe]:RPOSition</a> .....	293
<a href="#">DISPlay[:WINDow&lt;n&gt;]:TRACe&lt;t&gt;:X[:SCALe]:RVALue</a> .....	293

DISPlay[:WINDow<n>]:TRACe:Y[:SCALe].....	293
DISPlay[:WINDow<n>]:TRACe:Y[:SCALe]:PDIVision.....	294
DISPlay[:WINDow<n>]:TRACe:Y[:SCALe]:RPOSition.....	294
DISPlay[:WINDow<n>]:TRACe:Y[:SCALe]:RVALue.....	294
DISPlay[:WINDow<n>]:TRACe:Y:SPACing.....	294

---

### CALCulate<n>:STATistics:PRESet

This command sets the x- and y-axis of the statistics measurement to measurement dependent default values.

**Usage:** Event

**Manual control:** See "X-Axis Scaling" on page 149  
See "Default Settings" on page 149

---

### CALCulate<n>:STATistics:SCALE:AUTO ONCE

This command initiates an automatic scaling of the diagram (x- and y-axis).

To obtain maximum resolution, the level range is set as a function of the measured spacing between peak power and the minimum power for the APD measurement and of the spacing between peak power and mean power for the CCDF measurement. In addition, the probability scale for the number of test points is adapted.

To get valid results, you have to perform a complete sweep with synchronization to the end of the auto range process. This is only possible in single sweep mode.

**Parameters:**

ONCE

**Example:** `CALC:STAT:SCAL:AUTO ONCE;*WAI`  
Adapts the level setting for statistical measurements.

**Usage:** Event

**Manual control:** See "X-Axis Scaling" on page 149  
See "Adjust Settings" on page 149

---

### CALCulate<n>:STATistics:SCALE:X:BCOunt <StatNofColumns>

This command defines the number of columns for the statistical distribution.

**Setting parameters:**

<StatNofColumns> numeric value  
Range: 2 to 1024  
\*RST: 101  
Default unit: NONE

**Manual control:** See "X-Axis Scaling" on page 149  
See "Quantize" on page 149

**CALCulate<n>:STATistics:SCALE:Y:LOWer** <Magnitude>

This command defines the lower vertical limit of the diagram.

**Parameters:**

<Magnitude>            The number is a statistical value and therefore dimensionless.  
 Range:            1E-9 to 0.1  
 \*RST:            1E-6

**Example:**            `CALC:STAT:SCALE:Y:LOW 0.001`

**Manual control:**    See ["Defining Min and Max Values"](#) on page 148

**CALCulate<n>:STATistics:SCALE:Y:UPPer** <Magnitude>

This command defines the upper vertical limit of the diagram.

**Parameters:**

<Magnitude>            The number is a statistical value and therefore dimensionless.  
 Range:            1E-5 to 1.0  
 \*RST:            1.0

**Example:**            `CALC:STAT:SCALE:Y:UPP 0.01`

**Manual control:**    See ["Defining Min and Max Values"](#) on page 148

**CALCulate<n>:STATistics:SCALE:Y:UNIT** <Unit>

This command selects the unit of the y-axis.

**Parameters:**

<Unit>                    PCT | ABS  
 \*RST:            ABS

**Example:**            `CALC:STAT:SCALE:Y:UNIT PCT`  
 Sets the percentage scale.

**Manual control:**    See ["Y-Axis Unit"](#) on page 151

**CALCulate<n>:UNIT:ANGLE** <Unit>

This command selects the default unit for angles.

**Setting parameters:**

<Unit>                    DEG | RAD  
 \*RST:            RAD

**Manual control:**    See ["Y-Axis Unit"](#) on page 151

**CALCulate<n>:X:UNIT:TIME** <Unit>

This command selects the unit (symbols or seconds) for the x axis.

**Setting parameters:**

<Unit> S | SYM  
 \*RST: SYM

**Manual control:** See ["X-Axis Unit"](#) on page 150

**DISPlay[:WINDow<n>]:TRACe<t>:X[:SCALe]:PDIVision <PDiv>**

This command defines the scaling of the x-axis for statistical result displays.

For all other result displays, this command is only available as a query.

**Setting parameters:**

<PDiv> numeric value  
 Defines the range per division (total range = 10\* <PDiv>)

**Manual control:** See ["X-Axis Scaling"](#) on page 149  
 See ["Range per Division"](#) on page 149

**DISPlay[:WINDow<n>]:TRACe<t>:X[:SCALe]:RPOSition <RPos>**

This command defines the position of the reference value for the X axis.

Setting the position of the reference value is possible only for statistical result displays. All other result displays support the query only.

**Setting parameters:**

<RPos> numeric value  
 <numeric\_value>

**Example:** DISP:TRAC:X:RPOS 30 PCT  
 The reference value is shifted by 30% towards the left.

**Manual control:** See ["X-Axis Scaling"](#) on page 149  
 See ["X-Axis Reference Position"](#) on page 149

**DISPlay[:WINDow<n>]:TRACe<t>:X[:SCALe]:RVALue <RVal>**

This command defines the reference value for the x-axis for statistical result displays.

For all other result displays, this command is only available as a query.

**Setting parameters:**

<RVal> numeric value  
 Reference value for the x-axis

**Manual control:** See ["X-Axis Scaling"](#) on page 149  
 See ["X-Axis Reference Value"](#) on page 149

**DISPlay[:WINDow<n>]:TRACe:Y[:SCALe] <Range>**

This command defines the display range of the y-axis.

**Example:** `DISP:TRAC:Y 110dB`  
**Usage:** SCPI confirmed

#### **DISPlay[:WINDow<n>]:TRACe:Y[:SCALe]:PDIVision <Value>**

This remote command determines the grid spacing on the Y-axis for all diagrams, where possible.

**Parameters:**

<Value> numeric value; the unit depends on the result display  
 Defines the range per division (total range = 10\*<Value>)  
 \*RST: depends on the result display

**Example:** `DISP:TRAC:Y:PDIV 10`  
 Sets the grid spacing to 10 units (e.g. dB) per division

**Manual control:** See ["Configuring a Reference Point and Divisions"](#) on page 148  
 See ["Range per Division"](#) on page 148

#### **DISPlay[:WINDow<n>]:TRACe:Y[:SCALe]:RPOSition <Position>**

This command defines the vertical position of the reference level on the display grid.  
 The R&S FSW adjusts the scaling of the y-axis accordingly.

**Example:** `DISP:TRAC:Y:RPOS 50PCT`

**Usage:** SCPI confirmed

**Manual control:** See ["Configuring a Reference Point and Divisions"](#) on page 148  
 See ["Y-Axis Reference Position"](#) on page 148

#### **DISPlay[:WINDow<n>]:TRACe:Y[:SCALe]:RVALue <Value>**

The command defines the power value assigned to the reference position in the grid.

**Parameters:**

<Value> \*RST: 0 dBm, coupled to reference level

**Example:** `DISP:TRAC:Y:RVAL -20dBm`  
 Sets the power value assigned to the reference position to -20 dBm

**Manual control:** See ["Configuring a Reference Point and Divisions"](#) on page 148  
 See ["Y-Axis Reference Value"](#) on page 148

#### **DISPlay[:WINDow<n>]:TRACe:Y:SPACing <ScalingType>**

This command selects the scaling of the y-axis.

**Parameters:**

&lt;ScalingType&gt;

**LOGarithmic**

Logarithmic scaling.

**LINear**

Linear scaling in %.

**LDB**

Linear scaling in the specified unit.

**PERCent**

Linear scaling in %.

\*RST: LOGarithmic

**Example:**

DISP:TRAC:Y:SPAC LIN

Selects linear scaling in %.

**Usage:**

SCPI confirmed

**Manual control:**

See "Y-Axis Unit" on page 151

### 10.4.3 Signal Capture

The signal capture commands define how much, how and when data is captured from the input signal.

**MSRA operating mode**

In MSRA operating mode, only the MSRA Master channel actually captures data from the input signal. The data acquisition settings for the VSA application in MSRA mode define the **application data extract** and **analysis interval**.

For details on the MSRA operating mode see the R&S FSW MSRA User Manual.

The tasks for manual operation are described in [chapter 5.6, "Signal Capture"](#), on page 151.

<a href="#">CALCulate:MSRA:WINDow&lt;n&gt;:IVAL?</a> .....	295
<a href="#">[SENSe]:JDDEMod:PRATe.....</a>	296
<a href="#">[SENSe]:JDDEMod:RENgth:AUTO.....</a>	296
<a href="#">[SENSe]:JDDEMod:RENgth[:VALue].....</a>	296
<a href="#">[SENSe]:JDDEMod:SBANd.....</a>	297
<a href="#">TRACe:IQ:WBANd[:STATe].....</a>	297

**CALCulate:MSRA:WINDow<n>:IVAL?**

This command queries the analysis interval for the current window. This command is only available in application measurement channels, not the MSRA View or MSRA Master.

**Return values:**

&lt;IntStart&gt;

Start value of the analysis interval

Default unit: us

<IntStop> Stop value of the analysis interval  
 Default unit: us  
**Usage:** Query only

**[SENSe:]DDEMod:PRATe <CaptOverSmplg>**

Defines the number of samples that are captured per symbol, i.e. the factor by which the symbol rate is multiplied to obtain the sample rate. This parameter also affects the demodulation bandwidth and thus the usable I/Q bandwidth.

The sample rate depends on the defined [Symbol Rate](#) (see [chapter 4.2, "Sample Rate, Symbol Rate and I/Q Bandwidth"](#), on page 57).

**Setting parameters:**

<CaptOverSmplg> 4 | 8 | 16 | 32  
 The factor by which the symbol rate is multiplied to obtain the sample rate, e.g. 4 samples per symbol:  
 sample rate = 4\*symbol rate  
 \*RST: 4

**Manual control:** See ["Sample Rate"](#) on page 153

**[SENSe:]DDEMod:RLENgth:AUTO <RecLengthAuto>**

This command switches the automatic adaptation of the recording length on or off. The automatic adaptation is performed so that a sufficient recording length is set as a function of result length, burst and pattern search and network-specific characteristics (e.g. burst and frame structure).

**Setting parameters:**

<RecLengthAuto> ON | OFF  
 \*RST: ON

**Manual control:** See ["Capture Length Settings"](#) on page 152

**[SENSe:]DDEMod:RLENgth[:VALue] <RecordLength>**

This command defines the capture length for further processing, e.g. for burst search. The record length is defined in time (S, default) or symbols (SYM).

Note that the maximum record length depends on the sample rate for signal capture (see [\[SENSe:\]DDEMod:PRATe](#) on page 296). For the default value =4, the maximum is 50.000 symbols. For larger sample rates, the maximum record length (in symbols) can be calculated as:

$$\text{Recordlength}_{\text{MAX}} = 200.000 / \langle \text{points per symbol} \rangle$$



**Setting parameters:**

<RecordLength> numeric value  
 Range: 369.231 us to 184.615 ms  
 \*RST: 29.538 ms  
 Default unit: s (not symbols as in manual operation!)

**Manual control:** See "[Capture Length Settings](#)" on page 152

**[SENSe:]DDEMod:SBANd <SidebandPos>**

This command selects the sideband for the demodulation.

**Setting parameters:**

<SidebandPos> NORMal | INVerse  
**NORMal**  
 Normal (non-inverted) position  
**INVerse**  
 Inverted position  
 \*RST: NORMal

**Manual control:** See "[Swap I/Q](#)" on page 153

**TRACe:IQ:WBANd[:STATe] <State>**

Activates the bandwidth extension option R&S FSW-B160 / U160, if installed. Only if the extension is activated a bandwidth up to 160 MHz is available, which corresponds to a sample rate of 200 MHz. The extension must be activated for sample rates > 100 MHz.

**Note:** As opposed to manual operation, the bandwidth extension can also be activated for sample rates  $\leq$  100 MHz using this remote command. However, it is only actually employed when the sample rate exceeds 100 MHz. This simplifies creating remote programs as the sequence of activating the extension and controlling the sample rate is irrelevant.

**Parameters:**

<State> ON | OFF  
 \*RST: OFF

**Manual control:** See "[Maximum Bandwidth](#)" on page 153

#### 10.4.4 Triggering Measurements

The trigger commands define the beginning of a measurement.



### MSRA operating mode

In MSRA operating mode, only the MSRA Master channel actually captures data from the input signal. Thus, no trigger settings are available in the VSA application in MSRA operating mode. However, a **capture offset** can be defined with a similar effect as a trigger offset. It defines an offset from the start of the captured data (from the MSRA Master) to the start of the application data for vector signal analysis. (See [Capture Offset](#).)

For details on the MSRA operating mode see the R&S FSW MSRA User Manual.

Tasks for manual configuration are described in [chapter 5.6.2, "Trigger Settings"](#), on page 154.

<a href="#">TRIGger[:SEquence]:BBPower:HOLDoff</a> .....	298
<a href="#">TRIGger[:SEquence]:DTIME</a> .....	298
<a href="#">TRIGger[:SEquence]:HOLDoff[:TIME]</a> .....	299
<a href="#">TRIGger[:SEquence]:IFPower:HOLDoff</a> .....	299
<a href="#">TRIGger[:SEquence]:IFPower:HYSteresis</a> .....	299
<a href="#">TRIGger[:SEquence]:LEVel:BBPower</a> .....	300
<a href="#">TRIGger[:SEquence]:LEVel:EXternal&lt;port&gt;</a> .....	300
<a href="#">TRIGger[:SEquence]:LEVel:IFPower</a> .....	300
<a href="#">TRIGger[:SEquence]:LEVel:IQPower</a> .....	300
<a href="#">TRIGger[:SEquence]:SLOPe</a> .....	301
<a href="#">TRIGger[:SEquence]:SOURce</a> .....	301
<a href="#">[SENSe:]MSRA:CAPTure:OFFSet</a> .....	302

### TRIGger[:SEquence]:BBPower:HOLDoff <Period>

This command defines the holding time before the baseband power trigger event.

The command requires option R&S FSW-B17.

Note that this command is maintained for compatibility reasons only. Use the [TRIGger\[:SEquence\]:IFPower:HOLDoff](#) on page 299 command for new remote control programs.

#### Parameters:

<Period>                      Range:        150 ns to 1000 s  
                                      \*RST:        150 ns

#### Example:

```
TRIG:SOUR BBP
Sets the baseband power trigger source.
TRIG:BBP:HOLD 200 ns
Sets the holding time to 200 ns.
```

### TRIGger[:SEquence]:DTIME <DropoutTime>

Defines the time the input signal must stay below the trigger level before a trigger is detected again.

**Parameters:**

<DropoutTime> Dropout time of the trigger.  
 Range: 0 s to 10.0 s  
 \*RST: 0 s

**Manual control:** See "[Drop-Out Time](#)" on page 157

**TRIGger[:SEQuence]:HOLDoff[:TIME] <Offset>**

Defines the time offset between the trigger event and the start of the sweep (data capturing).

**Parameters:**

<Offset> The allowed range is 0 s to 30 s.  
 \*RST: 0 s

**Example:** TRIG:HOLD 500us

**Manual control:** See "[Trigger Offset](#)" on page 157

**TRIGger[:SEQuence]:IFPower:HOLDoff <Period>**

This command defines the holding time before the next trigger event.

Note that this command is available for **any trigger source**, not just IF Power.

**Note:** If you perform gated measurements in combination with the IF Power trigger, the R&S FSW ignores the holding time for frequency sweep, FFT sweep, zero span and I/Q data measurements.

**Parameters:**

<Period> \*RST: 150 ns

**Example:** TRIG:SOUR IFP  
 Sets the IF power trigger source.  
 TRIG:IFP:HOLD 200 ns  
 Sets the holding time to 200 ns.

**Manual control:** See "[Trigger Holdoff](#)" on page 158

**TRIGger[:SEQuence]:IFPower:HYSTeresis <Hysteresis>**

This command defines the trigger hysteresis.

**Parameters:**

<Hysteresis> Range: 3 dB to 50 dB  
 \*RST: 3 dB

**Example:** TRIG:SOUR IFP  
 Sets the IF power trigger source.  
 TRIG:IFP:HYST 10DB  
 Sets the hysteresis limit value.

**Manual control:** See "[Hysteresis](#)" on page 157

**TRIGger[:SEQuence]:LEVel:BBPower** <Level>

This command sets the level of the baseband power trigger.

This command is available with the **Digital Baseband Interface (R&S FSW-B17)**.

**Parameters:**

<Level>                    Range:        -50 dBm to +20 dBm  
                              \*RST:        -20 DBM

**Example:**                TRIG:LEV:BB -30DBM

**Manual control:**        See "[Trigger Level](#)" on page 156

**TRIGger[:SEQuence]:LEVel[:EXtErnal<port>]** <TriggerLevel>

This command defines the level the external signal must exceed to cause a trigger event.

**Suffix:**

<port>                    1 | 2 | 3  
                              Selects the trigger port.  
                              1 = trigger port 1 (TRIGGER INPUT connector on front panel)  
                              2 = trigger port 2 (TRIGGER INPUT/OUTPUT connector on front panel)  
                              3 = trigger port 3 (TRIGGER3 INPUT/OUTPUT connector on rear panel)

**Parameters:**

<TriggerLevel>           Range:        0.5 V to 3.5 V  
                              \*RST:        1.4 V

**Example:**                TRIG:LEV 2V

**Manual control:**        See "[Trigger Level](#)" on page 156

**TRIGger[:SEQuence]:LEVel:IFPower** <TriggerLevel>

This command defines the power level at the third intermediate frequency that must be exceeded to cause a trigger event. Note that any RF attenuation or preamplification is considered when the trigger level is analyzed.

**Parameters:**

<TriggerLevel>           Range:        -50 dBm to 20 dBm  
                              \*RST:        -20 dBm

**Example:**                TRIG:LEV:IFP -30DBM

**Manual control:**        See "[Trigger Level](#)" on page 156

**TRIGger[:SEQuence]:LEVel:IQPower** <TriggerLevel>

This command defines the magnitude the I/Q data must exceed to cause a trigger event. Note that any RF attenuation or preamplification is considered when the trigger level is analyzed.

**Parameters:**

<TriggerLevel>      Range:      -130 dBm to 30 dBm  
                              \*RST:      -20 dBm

**Example:**

TRIG:LEV:IQP -30DBM

**Manual control:**

See "[Trigger Level](#)" on page 156

**TRIGger[:SEQUence]:SLOPe <Type>**

For all trigger sources except time you can define whether triggering occurs when the signal rises to the trigger level or falls down to it.

**Parameters:**

<Type>                      POSitive | NEGative

**POSitive**

Triggers when the signal rises to the trigger level (rising edge).

**NEGative**

Triggers when the signal drops to the trigger level (falling edge).

\*RST:              POSitive

**Example:**

TRIG:SLOP NEG

**Manual control:**

See "[Slope](#)" on page 157

**TRIGger[:SEQUence]:SOURce <Source>**

This command selects the trigger source.

**Note on external triggers:**

If a measurement is configured to wait for an external trigger signal in a remote control program, remote control is blocked until the trigger is received and the program can continue. Make sure this situation is avoided in your remote control programs.

**Parameters:**

&lt;Source&gt;

**IMMediate**

Free Run

**EXTErn**

Trigger signal from the TRIGGER INPUT connector.

**EXT2**

Trigger signal from the TRIGGER INPUT/OUTPUT connector.

Note: Connector must be configured for "Input".

**EXT3**

Trigger signal from the TRIGGER 3 INPUT/ OUTPUT connector.

Note: Connector must be configured for "Input".

**IFPower**

Second intermediate frequency

**IQPower**

Magnitude of sampled I/Q data

For applications that process I/Q data, such as the I/Q Analyzer or optional applications

**BBPower**

Baseband power (for digital input via the Digital Baseband Interface R&amp;S FSW-B17)

\*RST: IMMediate

**Example:**

TRIG:SOUR EXT

Selects the external trigger input as source of the trigger signal

**Manual control:**See ["Trigger Source"](#) on page 155See ["Free Run"](#) on page 155See ["External Trigger 1/2/3"](#) on page 155See ["IF Power"](#) on page 156See ["Baseband Power"](#) on page 156See ["IQ Power"](#) on page 156**[SENSe:]MSRA:CAPTURE:OFFSet <Offset>**

This setting is only available for applications in MSRA mode, not for the MSRA Master. It has a similar effect as the trigger offset in other measurements.

**Parameters:**

&lt;Offset&gt;

This parameter defines the time offset between the capture buffer start and the start of the extracted application data. The offset must be a positive value, as the application can only analyze data that is contained in the capture buffer.

Range: 0 to &lt;Record length&gt;

\*RST: 0

**Manual control:**See ["Capture Offset"](#) on page 158

## 10.4.5 Configuring Sweeps

The sweep commands define how often data from the input signal is acquired and then evaluated.

Manual configuration of the sweeps is described in [chapter 5.6.3, "Sweep Settings"](#), on page 158.

<a href="#">[SENSe:]DDEMod:SEARCh:MBURst:CALC</a> .....	303
<a href="#">[SENSe:]SWEep:COUNT[:VALue]</a> .....	303
<a href="#">[SENSe:]SWEep:COUNT:CURRent</a> .....	303

---

### **[SENSe:]DDEMod:SEARCh:MBURst:CALC** <SelResRangeNr>

Sets the result range to be displayed after a single sweep (e.g. a burst number).

#### Setting parameters:

<SelResRangeNr> numeric value  
 Range: 1 to 1000000  
 \*RST: 1  
 Default unit: NONE

**Manual control:** See ["Select Result Rng"](#) on page 160

---

### **[SENSe:]SWEep:COUNT[:VALue]** <SweepCount>

This command sets the statistics count.

For more information see ["Statistic Count"](#) on page 159.

#### Setting parameters:

<SweepCount> numeric value  
**0**  
 activates "Auto" mode  
**numeric value > 0**  
 Activates "Manual" mode and sets the statistics count to the corresponding number.  
 Range: 0 to 32767  
 \*RST: 0  
 Default unit: NONE

**Usage:** SCPI confirmed

**Manual control:** See ["Statistic Count"](#) on page 159

---

### **[SENSe:]SWEep:COUNT:CURRent** <Counter>

This command queries the current statistics counter value which indicates how many result ranges have been evaluated. For results that use the capture buffer as a source, the number of used capture buffers can be queried.

**Setting parameters:**

<Counter> CAPTURE | STATISTICS

**STATISTICS**

Returns the number of result ranges that have been evaluated.

**CAPTURE**

Returns the number of used capture buffers evaluated.

\*RST: STATISTICS

## 10.4.6 Configuring Bursts and Patterns

The burst and pattern search settings can be configured, and new patterns can be defined.

Manual configuration of bursts and patterns is described in [chapter 5.7, "Burst and Pattern Configuration"](#), on page 160.

- [Burst Search](#).....304
- [Pattern Searches](#).....306
- [Configuring Patterns](#).....307

### 10.4.6.1 Burst Search

The burst search commands define when a burst is detected in the analyzed signal.

<a href="#">[SENSe:]DDEMod:SEARch:BURSt:AUTO</a> .....	304
<a href="#">[SENSe:]DDEMod:SEARch:BURSt:CONFIgure:AUTO</a> .....	304
<a href="#">[SENSe:]DDEMod:SEARch:BURSt:GLENgth[:MINimum]</a> .....	305
<a href="#">[SENSe:]DDEMod:SEARch:BURSt:MODE</a> .....	305
<a href="#">[SENSe:]DDEMod:SEARch:BURSt:STATe</a> .....	305
<a href="#">[SENSe:]DDEMod:SEARch:BURSt:TOLerance</a> .....	305

---

#### **[SENSe:]DDEMod:SEARch:BURSt:AUTO** <AutoBurstSearch>

This command links the burst search to the type of signal. When a signal is marked as bursted, burst search is switched on automatically.

**Setting parameters:**

<AutoBurstSearch> AUTO | MANual

\*RST: AUTO

**Manual control:** See "[Enabling Burst Searches](#)" on page 162

---

#### **[SENSe:]DDEMod:SEARch:BURSt:CONFIgure:AUTO** <AutoConfigure>

This command sets the search tolerance and the min gap length to their default values.

**Setting parameters:**

<AutoConfigure> ON | OFF

\*RST: ON



**Manual control:** See ["Burst Configuration"](#) on page 162

---

**[SENSe:]DDEMod:SEARch:BURSt:GLEnGth[:MINimum] <MinGapLength>**

This command defines the minimum time between two bursts. A minimum time with decreased level must occur between two bursts. The default unit is symbol. The value can also be given in seconds.

**Setting parameters:**

<MinGapLength> numeric value  
 Range: 1 to 15000  
 \*RST: 1  
 Default unit: SYM

**Manual control:** See ["Burst Configuration"](#) on page 162  
 See ["Min Gap Length"](#) on page 162

---

**[SENSe:]DDEMod:SEARch:BURSt:MODE <MeasOnlyOnBurst>**

This command sets the vector analyzer so that a measurement is performed only if a burst is found. The command is available only if the burst search is activated (see [\[SENSe:\]DDEMod:SEARch:BURSt:STATe](#) on page 305).

**Setting parameters:**

<MeasOnlyOnBurst> MEAS | BURS

**MEAS**  
 Measurement is always performed

**BURS**  
 Measurement is performed only if a burst is found

\*RST: MEAS

**Manual control:** See ["Measuring only if burst was found"](#) on page 162

---

**[SENSe:]DDEMod:SEARch:BURSt:STATe <SearchState>**

This command switches the search for a signal burst on or off.

**Setting parameters:**

<SearchState> ON | OFF  
 \*RST: OFF

---

**[SENSe:]DDEMod:SEARch:BURSt:TOLerance <SearchTolerance>**

This command controls burst search tolerance.

**Setting parameters:**

<SearchTolerance> numeric value  
 Range: 0 to 100000  
 \*RST: 4  
 Default unit: SYM

**Manual control:** See "[Burst Configuration](#)" on page 162  
 See "[Search Tolerance](#)" on page 162

**10.4.6.2 Pattern Searches**

The pattern search commands define when a pattern is detected in the analyzed signal.

[SENSe:]DDEMod:SEARch:PATtern:CONFigure:AUTO.....	306
[SENSe:]DDEMod:SEARch:SYNC:AUTO.....	306
[SENSe:]DDEMod:SEARch:SYNC:IQCThreshold.....	306
[SENSe:]DDEMod:SEARch:SYNC:MODE.....	307
[SENSe:]DDEMod:SEARch:SYNC:SElect.....	307
[SENSe:]DDEMod:SEARch:SYNC:STATe.....	307

**[SENSe:]DDEMod:SEARch:PATtern:CONFigure:AUTO <AutoConfigure>**

This command sets the IQ correlation threshold to its default value.

**Setting parameters:**

<AutoConfigure> ON | OFF  
 \*RST: ON

**Manual control:** See "[I/Q Correlation Threshold](#)" on page 164

**[SENSe:]DDEMod:SEARch:SYNC:AUTO <AutoPattSearch>**

This command links the pattern search to the type of signal. When a signal is marked as patterned, pattern search is switched on automatically.

**Setting parameters:**

<AutoPattSearch> AUTO | MANual  
 \*RST: AUTO

**Manual control:** See "[Enabling Pattern Searches](#)" on page 163

**[SENSe:]DDEMod:SEARch:SYNC:IQCThreshold <CorrelationLev>**

This command sets the IQ correlation threshold for pattern matching in percent. A high level means stricter matching.

**Setting parameters:**

<CorrelationLev> numeric value  
 Range: 10.0 to 100.0  
 \*RST: 90.0  
 Default unit: PCT

**Manual control:** See "[I/Q Correlation Threshold](#)" on page 164

---

**[SENSe:]DDEMod:SEARch:SYNC:MODE** <MeasOnlyOnPatt>

This command sets the vector analyzer so that the measurement is performed only if the measurement was synchronous to the selected sync pattern.

The command is available only if the pattern search is activated (see [\[SENSe:\]DDEMod:SEARch:SYNC:STATe](#) on page 307).

**Setting parameters:**

<MeasOnlyOnPatt> MEAS | SYNC

**MEAS**

The measurement is performed independently of successful synchronization

**SYNC**

The measured values are displayed and considered in the error evaluation only if the set sync pattern was found. Bursts with a wrong sync pattern (sync not found) are ignored. If an invalid or no sync pattern is found, the measurement waits and resumes running only when a valid sync pattern is found.

\*RST: OFF

**Manual control:** See "[Meas only if Pattern Symbols Correct](#)" on page 164

---

**[SENSe:]DDEMod:SEARch:SYNC:SElect** <Select>

This command selects a predefined sync pattern file.

**Setting parameters:**

<Select> string

**Manual control:** See "[Selected Pattern for Search](#)" on page 164

---

**[SENSe:]DDEMod:SEARch:SYNC:STATe** <PatternSearch>

This command switches the search for a sync sequence on or off.

**Setting parameters:**

<PatternSearch> ON | OFF

\*RST: OFF

**Manual control:** See "[Enabling Pattern Searches](#)" on page 163  
See "[Pattern Search On](#)" on page 167

### 10.4.6.3 Configuring Patterns

New patterns can be defined and assigned to a signal standard.

Useful commands for configuring patterns described elsewhere:

- [\[SENSe:\]DDEMod:SEARch:SYNC:STATe](#) on page 307
- [\[SENSe:\]DDEMod:SEARch:SYNC:CATalog](#) on page 277

#### Remote commands exclusive to configuring patterns:

<a href="#">[SENSe:]DDEMod:SEARch:SYNC:COMMeNt</a> .....	308
<a href="#">[SENSe:]DDEMod:SEARch:SYNC:COpy</a> .....	308
<a href="#">[SENSe:]DDEMod:SEARch:SYNC:DELeTe</a> .....	308
<a href="#">[SENSe:]DDEMod:SEARch:SYNC:DATA</a> .....	309
<a href="#">[SENSe:]DDEMod:SEARch:SYNC:NAME</a> .....	309
<a href="#">[SENSe:]DDEMod:SEARch:SYNC:NSTate</a> .....	309
<a href="#">[SENSe:]DDEMod:SEARch:SYNC:PATTeRn:ADD</a> .....	310
<a href="#">[SENSe:]DDEMod:SEARch:SYNC:PATTeRn:REMOve</a> .....	310
<a href="#">[SENSe:]DDEMod:SEARch:SYNC:TEXT</a> .....	310

---

#### **[SENSe:]DDEMod:SEARch:SYNC:COMMeNt** <Comment>

This command defines a comment to a sync pattern. The pattern must have been selected before using [\[SENSe:\]DDEMod:SEARch:SYNC:NAME](#) on page 309.

##### Setting parameters:

<Comment>            string

**Manual control:**    See "Edit" on page 166  
                           See "New" on page 166  
                           See "Comment" on page 169

---

#### **[SENSe:]DDEMod:SEARch:SYNC:COpy** <Pattern>

This command copies a pattern file. The pattern to be copied must have been selected before using [\[SENSe:\]DDEMod:SEARch:SYNC:NAME](#) on page 309.

**Tip:** In manual operation, a pattern can be copied in the editor by storing it under a new name.

##### Setting parameters:

<Pattern>            string

**Example:**            :DDEMod:SEAR:SYNC:NAME 'GSM\_TSC0'  
                           Selects the pattern.  
                           :DDEMod:SEAR:SYNC:COpy 'GSM\_PATT'  
                           Copies "GSM\_TSC0" to GSM\_PATT.

**Usage:**              Setting only

**Manual control:**    See "Save As" on page 166

---

#### **[SENSe:]DDEMod:SEARch:SYNC:DELeTe**

This command deletes a sync sequence. The sync sequence to be deleted must have been selected before using [\[SENSe:\]DDEMod:SEARch:SYNC:NAME](#) on page 309.

**Usage:** Event  
**Manual control:** See ["Delete"](#) on page 167

### **[SENSe:]DDEMod:SEARch:SYNC:DATA <Data>**

This command defines the sync sequence of a sync pattern. The pattern must have been selected before using [\[SENSe:\]DDEMod:SEARch:SYNC:NAME](#) on page 309.

**Important:** The value range of a symbol depends on the degree of modulation, e.g. for an 8PSK modulation the value range is from 0 to 7. The degree of modulation belongs to the pattern and is set using the `DDEM:SEAR:SYNC:NState` command (see [\[SENSe:\]DDEMod:SEARch:SYNC:NState](#) on page 309).

#### **Setting parameters:**

<Data> string  
 Four values represent a symbol (hexadecimal format). The value range of a symbol depends on the degree of modulation.  
 With a degree of modulation of 4, all symbols have a value range of: 0000, 0001, 0002, 0003  
 With a degree of modulation of 8:  
 0000, 0001, 0002, 0003, 0004, 0005, 0006, 0007

**Example:** `DDEM:SEAR:SYNC:DATA '00010000FFFF'`  
 Defines the pattern data.

**Manual control:** See ["Edit"](#) on page 166  
 See ["New"](#) on page 166  
 See ["Symbols"](#) on page 169

### **[SENSe:]DDEMod:SEARch:SYNC:NAME <Name>**

This command selects a sync pattern for editing or for a new entry.

#### **Setting parameters:**

<Name> string

**Manual control:** See ["Edit"](#) on page 166  
 See ["New"](#) on page 166  
 See ["Name"](#) on page 168

### **[SENSe:]DDEMod:SEARch:SYNC:NState <NState>**

This command selects the degree of modulation (number of permitted states). The pattern must have been selected before using [\[SENSe:\]DDEMod:SEARch:SYNC:NAME](#) on page 309.

The number of permitted states depends on the modulation mode.

#### **Setting parameters:**

<NState> numeric value

**Manual control:** See ["Mod. order"](#) on page 169

**[SENSe:]DDEMod:SEARch:SYNC:PATtern:ADD <AddPattern>**

This command adds a pattern to the current standard. Using the `DDEMod:SEAR:SYNC:SEL` command, only those patterns can be selected which belong to the current standard (see [\[SENSe:\]DDEMod:SEARch:SYNC:SELect](#) on page 307).

**Setting parameters:**

<AddPattern> string

**Usage:** Setting only

**Manual control:** See ["Adding patterns to a standard"](#) on page 166

**[SENSe:]DDEMod:SEARch:SYNC:PATtern:REMOve**

This command deletes one or all patterns from the current standard.

**Usage:** Setting only

**Manual control:** See ["Removing patterns from a standard"](#) on page 165

**[SENSe:]DDEMod:SEARch:SYNC:TEXT <Text>**

This command defines a text to explain the pattern. The text is displayed only in the selection menu (manual control). This text should be short and concise. Detailed information about the pattern is given in the comment (see [\[SENSe:\]DDEMod:SEARch:SYNC:COMMeNt](#) on page 308).

**Setting parameters:**

<Text> string

**Manual control:** See ["Edit"](#) on page 166  
See ["New"](#) on page 166  
See ["Description"](#) on page 168

## 10.4.7 Defining the Result Range

The result range determines which part of the capture buffer, burst or pattern is displayed.

Manual configuration of the result range is described in [chapter 5.8, "Result Range Configuration"](#), on page 169.

<a href="#">CALCulate&lt;n&gt;:TRACe&lt;t&gt;:ADJust:ALIGnment[:DEFault]</a> .....	310
<a href="#">CALCulate&lt;n&gt;:TRACe&lt;t&gt;:ADJust:ALIGnment:OFFSet</a> .....	311
<a href="#">CALCulate&lt;n&gt;:TRACe&lt;t&gt;:ADJust[:VALue]</a> .....	311
<a href="#">DISPlay[:WINDow&lt;n&gt;]:TRACe&lt;t&gt;:X[:SCALe]:VOFFSet</a> .....	312
<a href="#">[SENSe:]DDEMod:TIME</a> .....	312

**CALCulate<n>:TRACe<t>:ADJust:ALIGnment[:DEFault] <Alignment>**

This command defines where the reference point is to appear in the result range.

**Suffix:**

&lt;t&gt; 1..6

**Setting parameters:**

&lt;Alignment&gt; LEFT | CENTER | RIGHT

**LEFT**

The reference point is at the start of the result range.

**CENTER**

The reference point is in the middle of the result range.

**RIGHT**

The reference point is displayed at the end of the result range.

\*RST: LEFT

**Manual control:** See "[Alignment](#)" on page 171**CALCulate<n>:TRACe<t>:ADJJust:ALIGNment:OFFSet <FitOffset>**

This command shifts the display range (relative to the reference time) by the number of given symbols. The resolution is 1 symbol. A value >0 results in a shift towards the right, and a value <0 results in a shift towards the left.

**Suffix:**

&lt;t&gt; 1..6

**Setting parameters:**

&lt;FitOffset&gt; numeric value

Range: -8000 to 8000

\*RST: 0

Default unit: SYM

**Manual control:** See "[Offset](#)" on page 171**CALCulate<n>:TRACe<t>:ADJJust[:VALue] <Reference>**

This command defines the reference point for the display.

**Suffix:**

&lt;t&gt; 1..6

**Setting parameters:**

&lt;Reference&gt; TRIGger | BURSt | PATtern

**TRIGger**

The reference point is defined by the start of the capture buffer.

**BURSt**

The reference point is defined by the start/center/end of the burst.

**PATtern**

The instrument selects the reference point and the alignment.

\*RST: TRIGger

**Manual control:** See "[Reference](#)" on page 170

**DISPlay[:WINDow<n>]:TRACe<t>:X[:SCALe]:VOFFset <VOffset>**

This command defines an offset to numbering of the symbols (Except capture buffer).

**Setting parameters:**

<VOffset>            numeric value  
                          Range:        -100000 to 100000  
                          \*RST:        0  
                          Default unit: NONE

**Manual control:**    See "[Symbol Number at <Reference> Start](#)" on page 171

**[SENSe:]DDEMod:TIME <ResultLength>**

The command determines the number of displayed symbols (result length).

**Setting parameters:**

<ResultLength>        numeric value  
                          Range:        10 to 20000  
                          \*RST:        800  
                          Default unit: SYM

**Manual control:**    See "[Result Length](#)" on page 170

## 10.4.8 Demodulation Settings

During demodulation of the vector signal some undesired effects that may occur during transmission can be compensated for. Furthermore, you can influence the synchronization process.

Manual configuration of the demodulation process is described in [chapter 5.9, "Demodulation Settings"](#), on page 171.

<a href="#">[SENSe:]DDEMod:ECALc[:MODE]</a> .....	313
<a href="#">[SENSe:]DDEMod:ECALc:OFFSet</a> .....	313
<a href="#">[SENSe:]DDEMod:EPRate:AUTO</a> .....	314
<a href="#">[SENSe:]DDEMod:EPRate[:VALue]</a> .....	314
<a href="#">[SENSe:]DDEMod:EQUalizer:LENGth</a> .....	314
<a href="#">[SENSe:]DDEMod:EQUalizer:LOAD</a> .....	315
<a href="#">[SENSe:]DDEMod:EQUalizer:MODE</a> .....	315
<a href="#">[SENSe:]DDEMod:EQUalizer:RESet</a> .....	316
<a href="#">[SENSe:]DDEMod:EQUalizer:SAVE</a> .....	316
<a href="#">[SENSe:]DDEMod:EQUalizer[:STATe]</a> .....	317
<a href="#">[SENSe:]DDEMod:FSYNc:AUTO</a> .....	317
<a href="#">[SENSe:]DDEMod:FSYNc:LEVel</a> .....	317
<a href="#">[SENSe:]DDEMod:FSYNc:RESult?</a> .....	317
<a href="#">[SENSe:]DDEMod:FSYNc[:MODE]</a> .....	317
<a href="#">[SENSe:]DDEMod:KDAta:STATe</a> .....	318
<a href="#">[SENSe:]DDEMod:KDAta[:NAME]</a> .....	318
<a href="#">[SENSe:]DDEMod:NORMalize:ADRoop</a> .....	318
<a href="#">[SENSe:]DDEMod:NORMalize:CFDRift</a> .....	319



[SENSe:]DDEMod:NORMAlize:CHANnel.....	319
[SENSe:]DDEMod:NORMAlize:FDERror.....	319
[SENSe:]DDEMod:NORMAlize:IQIMbalance.....	319
[SENSe:]DDEMod:NORMAlize:IQOFfset.....	319
[SENSe:]DDEMod:NORMAlize:SRERror.....	320
[SENSe:]DDEMod:SEARch:PATTern:SYNC:AUTO.....	320
[SENSe:]DDEMod:SEARch:PATTern:SYNC[STATe].....	320

---

### [SENSe:]DDEMod:ECALc[:MODE] <EvmCalc>

This command defines the calculation formula for EVM.

#### Setting parameters:

<EvmCalc>           SIGNal | SYMBol | MECPower | MACPower

#### **SIGNal**

Calculation normalized to the average power within the measurement range (mean ref power)

#### **SYMBol**

Calculation normalized to the maximum power at symbol times (max ref power)

#### **MECPower**

Calculation normalized to mean constellation power

#### **MACPower**

Calculation normalized to maximum constellation power

\*RST:           SIGN

**Manual control:**    See "[Normalize EVM to](#)" on page 176

---

### [SENSe:]DDEMod:ECALc:OFFSet <EVMOffsetState>

Configures the way the VSA application calculates the error vector results for offset QPSK.

#### Setting parameters:

<EVMOffsetState>   ON | OFF

#### **ON**

VSA application compensates the delay of the Q component with respect to the I component in the measurement signal as well as the reference signal before calculating the error vector. That means that the error vector contains only one symbol instant per symbol period.

#### **OFF**

the VSA application subtracts the measured signal from the reference signal to calculate the error vector. This method results in the fact that the error vector contains two symbol instants per symbol period: one that corresponds to the I component and one that corresponds to the Q component.

\*RST:           ON

**Manual control:** See ["Offset EVM"](#) on page 179

---

**[SENSe:]DDEMod:EPRate:AUTO** <LinkMode>

Defines how many sample points are used at each symbol to calculate modulation accuracy results automatically.

If enabled, the VSA application uses the following settings, depending on the modulation type:

Modulation	Est. Points
PSK, QAM	1
Offset QPSK	2
FSK, MSK	Sample rate (see <a href="#">[SENSe:]DDEMod:PRATe</a> on page 296)

**Setting parameters:**

<LinkMode> ON | OFF  
\*RST: ON

**Manual control:** See ["Estimation Points/Sym"](#) on page 177

---

**[SENSe:]DDEMod:EPRate[:VALue]** <EstOverSmplg>

Defines how many sample points are used at each symbol to calculate modulation accuracy results.

For more information see ["Estimation points per symbol"](#) on page 115.

You can also let the VSA application decide how many estimation points to use, see [\[SENSe:\]DDEMod:EPRate:AUTO](#) on page 314.

**Setting parameters:**

<EstOverSmplg> **1**  
the estimation algorithm takes only the symbol time instants into account  
**2**  
two points per symbol instant are used (required for Offset QPSK)  
**4 | 8 | 16 | 32**  
the number of samples per symbol defined in the signal capture settings is used (see [\[SENSe:\]DDEMod:PRATe](#) on page 296), i.e. all sample time instants are weighted equally  
\*RST: 1

**Manual control:** See ["Estimation Points/Sym"](#) on page 177

---

**[SENSe:]DDEMod:Equalizer:LENGTH** <FilterLength>

This command defines the length of the equalizer in terms of symbols.

**Setting parameters:**

<FilterLength>      numeric value  
 Range:            1 to 256  
 \*RST:            10  
 Default unit: SYM

**Example:**

DDEM:EQU:LENG 101  
 Sets the equalizer length to 101 symbols.

**Manual control:**

See ["Equalizer Settings"](#) on page 174  
 See ["Filter Length"](#) on page 175

**[SENSe:]DDEMod:EQualizer:LOAD <Name>**

This command selects a user-defined equalizer. The equalizer mode is automatically switched to `USER` (see [\[SENSe:\]DDEMod:EQualizer:MODE](#) on page 315).

**Setting parameters:**

<Name>                string  
 Path and file name (without extension)

**Example:**

DDEM:EQU:LOAD 'D:\MyEqualizer'  
 Selects equalizer named `MyEqualizer` in directory `D`.

**Manual control:**

See ["Equalizer Settings"](#) on page 174  
 See ["Store/Load Current Equalizer"](#) on page 175

**[SENSe:]DDEMod:EQualizer:MODE <Mode>**

Switches between the equalizer modes.

For details see [chapter 4.4.5, "The Equalizer"](#), on page 93.

**Setting parameters:**

&lt;Mode&gt;

**NORMAL**

Switches the equalizer on for the next sweep.

**TRACKing**

Switches the equalizer on; the results of the equalizer in the previous sweep are considered to calculate the new filter.

**FREeze**

The filter is no longer changed, the current equalizer values are used for subsequent sweeps.

**USER**

A user-defined equalizer loaded from a file is used.

**AVERaging**Switches the equalizer on; the results of the equalizer in all previous sweeps (since the instrument was switched on or the equalizer was reset) are considered to calculate the new filter. To start a new averaging process, use the `[SENSe:]DDEMod:EQualizer:RESet` on page 316 command.

\*RST: TRACe

**Example:**

DDEM:EQU:MODE TRAC

Activates the tracking mode of the equalizer.

**Manual control:**

See "Equalizer Settings" on page 174

See "Mode" on page 174

**[SENSe:]DDEMod:EQualizer:RESet**

This command deletes the data of the currently selected equalizer. After deletion, training can start again using the command `DDEM:EQU:MODE TRA` (see `[SENSe:]DDEMod:EQualizer:MODE` on page 315).

**Usage:** Event**Manual control:** See "Equalizer Settings" on page 174

See "Reset Equalizer" on page 175

**[SENSe:]DDEMod:EQualizer:SAVE <Name>**

This command saves the current equalizer results to a file.

**Setting parameters:**

&lt;Name&gt; string

File name

**Example:**

DDEM:EQU:SAVE 'D:\MyEqualizer'

Saves the current equalizer results to `D:\MyEqualizer.vae`.**Manual control:**

See "Equalizer Settings" on page 174

See "Store/Load Current Equalizer" on page 175

---

**[SENSe:]DDEMod:EQUalizer[:STATe] <State>**

This command activates or deactivates the equalizer.

For more information on the equalizer see [chapter 4.4.5, "The Equalizer"](#), on page 93.

**Setting parameters:**

<State> ON | OFF  
\*RST: OFF

**Example:** DDEMod:EQU OFF

**Manual control:** See ["Equalizer Settings"](#) on page 174  
See ["State"](#) on page 174

---

**[SENSe:]DDEMod:FSYNc:AUTO <FineSyncAuto>**

This command selects manual or automatic Fine Sync

**Setting parameters:**

<FineSyncAuto> ON | OFF  
\*RST: ON

**Manual control:** See ["Fine Synchronization"](#) on page 178

---

**[SENSe:]DDEMod:FSYNc:LEVel <SERLevel>**

This command sets the Fine Sync Level if fine sync works on Known Data

**Setting parameters:**

<SERLevel> numeric value  
Range: 0.0 to 100.0  
\*RST: 10.0  
Default unit: PCT

**Manual control:** See ["If SER ≤"](#) on page 179

---

**[SENSe:]DDEMod:FSYNc:RESult?**

The result of this query is 0 if the fine sync with known data failed, otherwise 1.

**Usage:** Query only

**Manual control:** See ["Fine Synchronization"](#) on page 178

---

**[SENSe:]DDEMod:FSYNc[:MODE] <FineSync>**

This command defines the fine synchronization mode used to calculate results, e.g. the bit error rate.

**Note:** You can define a maximum symbol error rate (SER) for the known data in reference to the analyzed data. If the SER of the known data exceeds this limit, the default synchronization using the detected data is performed. See [\[SENSe:\]DDEMod:FSYNc:LEVel](#) on page 317.

**Setting parameters:**

<FineSync> KDATa | PATTErn | DDATa

**KDATa**

The reference signal is defined as the data sequence from the loaded Known Data file that most closely matches the measured data.

**PATTErn**

The reference signal is estimated from the defined pattern.

This setting requires an activated pattern search, see [\[SENSe:\]DDEMod:SEARch:SYNC:STATe](#) on page 307.

**DDATa**

(Default) The reference signal is estimated from the detected data.

\*RST: DDATa

**Manual control:** See ["Fine Synchronization"](#) on page 178

**[SENSe:]DDEMod:KDATa:STATe** <KnownDataState>

This command selects the Known Data state. The use of known data is a prerequisite for the BER measurement and can also be used for the fine sync.

**Setting parameters:**

<KnownDataState> ON | OFF

\*RST: OFF

**Manual control:** See ["Known Data"](#) on page 134

**[SENSe:]DDEMod:KDATa[:NAME]** <FileName>

This command selects the Known Data file

**Setting parameters:**

<FileName> string

**Manual control:** See ["Load Data File"](#) on page 134

**[SENSe:]DDEMod:NORMALize:ADRoop** <CompAmptDroop>

This command switches the compensation of the amplitude droop on or off.

**Setting parameters:**

<CompAmptDroop> ON | OFF

\*RST: ON

**Manual control:** See ["Compensate for... \(PSK, MSK, ASK, QAM\)"](#) on page 173

---

**[SENSe:]DDEMod:NORMALize:CFDRift** <CarrFreqDrift>

This command defines whether the carrier frequency drift is compensated for FSK modulation.

**Setting parameters:**

<CarrFreqDrift> ON | OFF  
\*RST: OFF

**Manual control:** See "[Compensate for... \(FSK\)](#)" on page 174

---

**[SENSe:]DDEMod:NORMALize:CHANnel** <TransmitChannel>

This command switches the channel compensation on or off. (With equalizer only)

**Setting parameters:**

<TransmitChannel> ON | OFF  
\*RST: ON

**Manual control:** See "[Compensate for... \(PSK, MSK, ASK, QAM\)](#)" on page 173

---

**[SENSe:]DDEMod:NORMALize:FDERror** <RefDevComp>

This command defines whether the deviation error is compensated for when calculating the frequency error for FSK modulation.

**Setting parameters:**

<RefDevComp> ON | OFF  
**ON**  
Scales the reference signal to the actual deviation of the measurement signal.  
**OFF**  
Uses the entered nominal deviation for the reference signal.  
\*RST: ON

**Manual control:** See "[Compensate for... \(FSK\)](#)" on page 174

---

**[SENSe:]DDEMod:NORMALize:IQIMbalance** <ComplQImbalance>

This command switches the compensation of the IQ imbalance on or off.

**Setting parameters:**

<ComplQImbalance> ON | OFF  
\*RST: OFF

**Manual control:** See "[Compensate for... \(PSK, MSK, ASK, QAM\)](#)" on page 173

---

**[SENSe:]DDEMod:NORMALize:IQOFFset** <ComplQOffset>

This command switches the compensation of the IQ offset on or off.

**Setting parameters:**

<CompIQOffset> ON | OFF  
 \*RST: ON

**Manual control:** See "[Compensate for... \(PSK, MSK, ASK, QAM\)](#)" on page 173

**[SENSe:]DDEMod:NORMAlize:SRERror** <SymbolClockError>

This command switches the compensation for symbol rate error on or off

**Setting parameters:**

<SymbolClockError> ON | OFF  
 \*RST: OFF

**Manual control:** See "[Compensate for... \(PSK, MSK, ASK, QAM\)](#)" on page 173  
 See "[Compensate for... \(FSK\)](#)" on page 174

**[SENSe:]DDEMod:SEARch:PATTern:SYNC:AUTO** <UseWfmForSync>

This command selects manual or automatic synchronization with a pattern waveform to speed up measurements.

**Setting parameters:**

<UseWfmForSync> AUTO | MANual  
 \*RST: AUTO

**Manual control:** See "[Coarse Synchronization](#)" on page 177

**[SENSe:]DDEMod:SEARch:PATTern:SYNC[:STATe]** <FastSync>

This command switches fast synchronization on and off, if you manually synchronize with a waveform pattern.

**Setting parameters:**

<FastSync> ON | OFF  
 \*RST: OFF

**Manual control:** See "[Coarse Synchronization](#)" on page 177

## 10.4.9 Measurement Filter Settings

You can configure the measurement filter to be used.

Manual configuration of the measurement filter is described in [chapter 5.10, "Measurement Filter Settings"](#), on page 179.

For more information on measurement filters, refer to [chapter 4.1.4, "Measurement Filters"](#), on page 53.

Useful commands for defining measurement filters described elsewhere:

- [\[SENSe:\]DDEMod:FILTer:ALPHa](#) on page 269



- [\[SENSe:\]DDEMod:FILTER\[:STATE\]](#) on page 269

#### Remote commands exclusive to configuring measurement filters:

<a href="#">[SENSe:]DDEMod:MFILter:ALPHA</a> .....	321
<a href="#">[SENSe:]DDEMod:MFILter:AUTO</a> .....	321
<a href="#">[SENSe:]DDEMod:MFILter:NAME</a> .....	321
<a href="#">[SENSe:]DDEMod:MFILter[:STATE]</a> .....	321
<a href="#">[SENSe:]DDEMod:MFILter:USER</a> .....	322

---

#### **[SENSe:]DDEMod:MFILter:ALPHA** <MeasFiltAlphaBT>

This command sets the alpha value of the measurement filter.

##### Setting parameters:

<MeasFiltAlphaBT> numeric value  
 Range: 0.1 to 1.0  
 \*RST: 0.22  
 Default unit: NONE

**Manual control:** See "Type" on page 180  
 See "Alpha/BT" on page 181

---

#### **[SENSe:]DDEMod:MFILter:AUTO** <MeasFilterAuto>

If this command is set to "ON", the measurement filter is defined automatically depending on the transmit filter (see [\[SENSe:\]DDEMod:TFILter:NAME](#) on page 275).

##### Setting parameters:

<MeasFilterAuto> ON | OFF  
 \*RST: ON

**Manual control:** See "Using the Transmit Filter as a Measurement Filter (Auto)" on page 180

---

#### **[SENSe:]DDEMod:MFILter:NAME** <Name>

This command selects a measurement filter and automatically sets its state to "ON".

##### Setting parameters:

<Name> Name of the measurement filter or 'User' for a user-defined filter.  
 An overview of available measurement filters is provided in [chapter A.2.2, "Measurement Filters"](#), on page 404.

**Manual control:** See "Type" on page 180

---

#### **[SENSe:]DDEMod:MFILter[:STATE]** <MeasFilterState>

Use this command to switch the measurement filter off. To switch a measurement filter on, use the [\[SENSe:\]DDEMod:MFILter:NAME](#) command.

**Setting parameters:**

&lt;MeasFilterState&gt; ON | OFF

**OFF**

Switches the measurement filter off.

**ON**

Switches the measurement filter specified by [SENSe:] DDEMod:MFILter:NAME on. However, this command is not necessary, as the [SENSe:] DDEMod:MFILter:NAME command automatically switches the selected filter on.

\*RST: ON

**Manual control:** See "Type" on page 180**[SENSe:]DDEMod:MFILter:USER <FilterName>**

This command selects the user-defined measurement filter.

For details on user-defined filters, see [chapter 4.1.5, "Customized Filters"](#), on page 55.**Setting parameters:**

&lt;FilterName&gt; Name of the user-defined filter

**Example:**

SENS:DDEM:MFIL:NAME 'USER'

Selects user filter mode for the meas filter

ENS:DDEM:MFIL:USER 'D:\MyMeasFilter'

Selects the user-defined meas filter

**Manual control:** See "Type" on page 180  
See "Load User Filter" on page 181

### 10.4.10 Defining the Evaluation Range

The evaluation range defines which range of the result is to be evaluated.

Manual configuration of the evaluation range is described in [chapter 5.11, "Evaluation Range Configuration"](#), on page 181.

CALCulate<n>:ELIN<startstop>:STATe.....	322
CALCulate<n>:ELIN<startstop>[:VALue].....	323

**CALCulate<n>:ELIN<startstop>:STATe <Auto>**

This command restricts the evaluation range. The evaluation range is considered for the following display types:

- eye diagrams
- constellation diagrams
- modulation accuracy
- statistic displays
- spectrum displays

**Suffix:**

<startstop> 1..2  
irrelevant

**Setting parameters:**

<Auto> ON | OFF

**ON**

The evaluation range extends from the start value defined by `CALC:ELIN1:VAL` to the stop value defined by `CALC:ELIN2:VAL` (see [CALCulate<n>:ELIN<startstop>\[:VALue\]](#) on page 323).

**OFF**

The complete result area is evaluated.

\*RST: OFF

**Manual control:** See ["Evaluating the Entire Result Range"](#) on page 182

**CALCulate<n>:ELIN<startstop>[:VALue] <LeftDisp>**

Defines the start and stop values for the evaluation range (see [CALCulate<n>:ELIN<startstop>:STATe](#) on page 322).

**Suffix:**

<startstop> 1..2  
1: start value, 2: stop value

**Setting parameters:**

<LeftDisp> numeric value  
Range: 0 to 1000000  
\*RST: 0  
Default unit: SYM

**Manual control:** See ["Start / Stop"](#) on page 182

### 10.4.11 Adjusting Settings Automatically

Some settings can be adjusted by the R&S FSW automatically according to the current measurement settings.

Manual execution of automatic adjustment functions is described in [chapter 5.12, "Adjusting Settings Automatically"](#), on page 183.

<a href="#">DISPlay[:WINDow&lt;n&gt;]:TRACe:Y[:SCALe]:AUTO ONCE</a> .....	324
<a href="#">DISPlay[:WINDow&lt;n&gt;]:TRACe&lt;t&gt;:Y[:SCALe]:AUTO:ALL</a> .....	324
<a href="#">[SENSe:]ADJJust:CONFIgure:DURation</a> .....	324
<a href="#">[SENSe:]ADJJust:CONFIgure:DURation:MODE</a> .....	324
<a href="#">[SENSe:]ADJJust:CONFIgure:HYSteresis:LOWer</a> .....	325
<a href="#">[SENSe:]ADJJust:CONFIgure:HYSteresis:UPPer</a> .....	325
<a href="#">[SENSe:]ADJJust:LEVel</a> .....	326
<a href="#">[SENSe:]DDEMod:PRESet:RLEVel</a> .....	326

**DISPlay[:WINDow<n>]:TRACe:Y[:SCALe]:AUTO ONCE**

Automatic scaling of the y-axis is performed once, then switched off again.

**Usage:** SCPI confirmed

**Manual control:** See ["Auto Scale Once/Auto Scale Window"](#) on page 148

**DISPlay[:WINDow<n>]:TRACe<t>:Y[:SCALe]:AUTO:ALL**

Automatic scaling of the y-axis is performed once in all windows, then switched off again.

**Usage:** Event

**Manual control:** See ["Auto Scale All"](#) on page 184

**[SENSe:]ADJJust:CONFIgure:DURation <Duration>**

In order to determine the ideal reference level, the R&S FSW performs a measurement on the current input data. This command defines the length of the measurement if [\[SENSe:\]ADJJust:CONFIgure:DURation:MODE](#) is set to `MANual`.

**Parameters:**

<Duration>            Numeric value in seconds  
 Range:            0.001 to 16000.0  
 \*RST:            0.001  
 Default unit: s

**Example:**

`ADJ:CONF:DUR:MODE MAN`  
 Selects manual definition of the measurement length.  
`ADJ:CONF:LEV:DUR 5ms`  
 Length of the measurement is 5 ms.

**Manual control:** See ["Changing the Automatic Measurement Time \(Meastime Manual\)"](#) on page 183

**[SENSe:]ADJJust:CONFIgure:DURation:MODE <Mode>**

In order to determine the ideal reference level, the R&S FSW performs a measurement on the current input data. This command selects the way the R&S FSW determines the length of the measurement .

**Parameters:**

<Mode>            **AUTO**  
 The R&S FSW determines the measurement length automatically according to the current input data.

**MANual**  
 The R&S FSW uses the measurement length defined by [\[SENSe:\]ADJJust:CONFIgure:DURation](#) on page 324.

\*RST:            AUTO

**Manual control:** See ["Resetting the Automatic Measurement Time \(Meastime Auto\)"](#) on page 183  
 See ["Changing the Automatic Measurement Time \(Meastime Manual\)"](#) on page 183

---

#### [SENSe:]ADJust:CONFigure:HYSTerisis:LOWer <Threshold>

When the reference level is adjusted automatically using the [SENSe:]ADJust:LEVEl on page 326 command, the internal attenuators and the preamplifier are also adjusted. In order to avoid frequent adaptation due to small changes in the input signal, you can define a hysteresis. This setting defines a lower threshold the signal must fall below (compared to the last measurement) before the reference level is adapted automatically.

**Parameters:**

<Threshold>            Range:     0 dB to 200 dB  
                              \*RST:     +1 dB  
                              Default unit: dB

**Example:**

SENS:ADJ:CONF:HYST:LOW 2

For an input signal level of currently 20 dBm, the reference level will only be adjusted when the signal level falls below 18 dBm.

**Manual control:** See ["Lower Level Hysteresis"](#) on page 184

---

#### [SENSe:]ADJust:CONFigure:HYSTerisis:UPPer <Threshold>

When the reference level is adjusted automatically using the [SENSe:]ADJust:LEVEl on page 326 command, the internal attenuators and the preamplifier are also adjusted. In order to avoid frequent adaptation due to small changes in the input signal, you can define a hysteresis. This setting defines an upper threshold the signal must exceed (compared to the last measurement) before the reference level is adapted automatically.

**Parameters:**

<Threshold>            Range:     0 dB to 200 dB  
                              \*RST:     +1 dB  
                              Default unit: dB

**Example:**

SENS:ADJ:CONF:HYST:UPP 2

**Example:**

For an input signal level of currently 20 dBm, the reference level will only be adjusted when the signal level rises above 22 dBm.

**Manual control:** See ["Upper Level Hysteresis"](#) on page 184

**[SENSe:]ADJust:LEVel**  
**[SENSe:]DDEMod:PRESet:RLEVel**

This command initiates a measurement that evaluates and sets the ideal reference level for the current measurement. This ensures that the settings of the RF attenuation and the reference level are optimally adjusted to the signal level without overloading the R&S FSW or limiting the dynamic range by an S/N ratio that is too small.

**Usage:** Event

## 10.5 Performing a Measurement

When the VSA application is activated, a continuous sweep is performed automatically. However, you can stop and start a new measurement any time.

Furthermore, you can perform a sequence of measurements using the Sequencer (see "[Multiple Measurement Channels and Sequencer Function](#)" on page 12).

ABORt.....	326
INITiate:CONMeas.....	327
INITiate:CONTInuous.....	327
INITiate[:IMMediate].....	328
INITiate:REFMeas.....	329
INITiate:REFResh.....	329
INITiate:SEQuencer:REFResh[:ALL].....	329
INITiate:SEQuencer:ABORt.....	330
INITiate:SEQuencer:IMMediate.....	330
INITiate:SEQuencer:MODE.....	330
SYSTem:SEQuencer.....	331

### ABORt

This command aborts a current measurement and resets the trigger system.

To prevent overlapping execution of the subsequent command before the measurement has been aborted successfully, use the \*OPC? or \*WAI command after ABOR and before the next command.

For details see the "Remote Basics" chapter in the R&S FSW User Manual.

To abort a sequence of measurements by the Sequencer, use the [INITiate:SEQuencer:ABORt](#) on page 330 command.

#### Note on blocked remote control programs:

If a sequential command cannot be completed, for example because a triggered sweep never receives a trigger, the remote control program will never finish and the remote channel (GPIB, LAN or other interface) to the R&S FSW is blocked for further commands. In this case, you must interrupt processing on the remote channel first in order to abort the measurement.

To do so, send a "Device Clear" command from the control instrument to the R&S FSW on a parallel channel to clear all currently active remote channels. Depending on the used interface and protocol, send the following commands:

- **Visa:** `viClear()`
- **GPIB:** `ibclr()`
- **RSIB:** `RSDLLibclr()`

Now you can send the `ABORt` command on the remote channel performing the measurement.

**Example:** `ABOR; :INIT:IMM`  
Aborts the current measurement and immediately starts a new one.

**Example:** `ABOR; *WAI`  
`INIT:IMM`  
Aborts the current measurement and starts a new one once abortion has been completed.

**Usage:** SCPI confirmed

### **INITiate:CONMeas**

This command restarts a (single) measurement that has been stopped (using `INIT:CONT OFF`) or finished in single sweep mode.

The measurement is restarted at the beginning, not where the previous measurement was stopped.

As opposed to `INITiate[:IMMediate]`, this command does not reset traces in maxhold, minhold or average mode. Therefore it can be used to continue measurements using maxhold or averaging functions.

**Example:** (for Spectrum application):  
`INIT:CONT OFF`  
Switches to single sweep mode.  
`DISP:WIND:TRAC:MODE AVER`  
Switches on trace averaging.  
`SWE:COUN 20`  
Setting the sweep counter to 20 sweeps.  
`INIT; *WAI`  
Starts the measurement and waits for the end of the 20 sweeps.  
`INIT:CONM; *WAI`  
Continues the measurement (next 20 sweeps) and waits for the end.  
Result: Averaging is performed over 40 sweeps.

**Manual control:** See "[Continue Single Sweep](#)" on page 159

### **INITiate:CONTinuous <State>**

This command controls the sweep mode.

Note that in single sweep mode, you can synchronize to the end of the measurement with \*OPC, \*OPC? or \*WAI. In continuous sweep mode, synchronization to the end of the measurement is not possible. Thus, it is not recommended that you use continuous sweep mode in remote control, as results like trace data or markers are only valid after a single sweep end synchronization.

For details on synchronization see the "Remote Basics" chapter in the R&S FSW User Manual.

If the sweep mode is changed for a measurement channel while the Sequencer is active (see `INITiate:SEQuencer:IMMediate` on page 330) the mode is only considered the next time the measurement in that channel is activated by the Sequencer.

**Parameters:**

<State>                    ON | OFF  
                               **ON**  
                               Continuous sweep  
                               **OFF**  
                               Single sweep  
                               \*RST:        ON

**Example:**

```
INIT:CONT OFF
Switches the sweep mode to single sweep.
INIT:CONT ON
Switches the sweep mode to continuous sweep.
```

**Manual control:**        See "[Continuous Sweep/RUN CONT](#)" on page 158

**INITiate[:IMMediate]**

This command starts a (single) new measurement.

For a statistics count > 0, this means a restart of the corresponding number of measurements. With trace mode MAXHold, MINHold and AVERage, the previous results are reset on restarting the measurement.

You can synchronize to the end of the measurement with \*OPC, \*OPC? or \*WAI.

For details on synchronization see the "Remote Basics" chapter in the R&S FSW User Manual.

**Example:**

```
(For Spectrum application:)
INIT:CONT OFF
Switches to single sweep mode.
DISP:WIND:TRAC:MODE AVER
Switches on trace averaging.
SWE:COUN 20
Sets the sweep counter to 20 sweeps.
INIT;*WAI
Starts the measurement and waits for the end of the 20 sweeps.
```

**Manual control:**        See "[Single Sweep/ RUN SINGLE](#)" on page 159



---

**INITiate:REFMeas**

Repeats the evaluation of the data currently in the capture buffer without capturing new data. This is useful after changing settings, for example filters, patterns or evaluation ranges.

**Usage:** Event

**Manual control:** See "Refresh (non-MSRA mode)" on page 159

---

**INITiate:REFResh**

This function is only available if the Sequencer is deactivated (`SYSTem:SEQuencer SYST:SEQ:OFF`) and only for applications in MSRA mode, not the MSRA Master.

The data in the capture buffer is re-evaluated by the currently active application only. The results for any other applications remain unchanged.

**Example:**

```
SYST:SEQ:OFF
Deactivates the scheduler
INIT:CONT OFF
Switches to single sweep mode.
INIT;*WAI
Starts a new data measurement and waits for the end of the
sweep.
INST:SEL 'IQ ANALYZER'
Selects the IQ Analyzer channel.
INIT:REFR
Refreshes the display for the I/Q Analyzer channel.
```

**Usage:** Event

**Manual control:** See "Refresh" on page 160

---

**INITiate:SEQuencer:REFResh[:ALL]**

This function is only available if the Sequencer is deactivated (`SYSTem:SEQuencer SYST:SEQ:OFF`) and only in MSRA mode.

The data in the capture buffer is re-evaluated by all active MSRA applications.

**Example:**

```
SYST:SEQ:OFF
Deactivates the scheduler
INIT:CONT OFF
Switches to single sweep mode.
INIT;*WAI
Starts a new data measurement and waits for the end of the
sweep.
INIT:SEQ:REFR
Refreshes the display for all MSRA channels.
```

**Usage:** Event

---

**INITiate:SEQuencer:ABORt**

This command stops the currently active sequence of measurements. The Sequencer itself is not deactivated, so you can start a new sequence immediately using [INITiate:SEQuencer:IMMediate](#) on page 330.

To deactivate the Sequencer use [SYSTem:SEQuencer](#) on page 331.

**Usage:** Event

---

**INITiate:SEQuencer:IMMediate**

This command starts a new sequence of measurements by the Sequencer. Its effect is similar to the [INITiate\[:IMMediate\]](#) command used for a single measurement.

Before this command can be executed, the Sequencer must be activated (see [SYSTem:SEQuencer](#) on page 331).

**Example:**

```
SYST:SEQ ON
Activates the Sequencer.
INIT:SEQ:MODE SING
Sets single Sequencer mode so each active measurement will be
performed once.
INIT:SEQ:IMM
Starts the sequential measurements.
```

**Usage:** Event

---

**INITiate:SEQuencer:MODE <Mode>**

This command selects the way the R&S FSW application performs measurements sequentially.

Before this command can be executed, the Sequencer must be activated (see [SYSTem:SEQuencer](#) on page 331).

A detailed programming example is provided in the "Operating Modes" chapter in the R&S FSW User Manual.

**Note:** In order to synchronize to the end of a sequential measurement using \*OPC, \*OPC? or \*WAI you must use `SINGLE` Sequencer mode.

For details on synchronization see the "Remote Basics" chapter in the R&S FSW User Manual.

**Parameters:**

&lt;Mode&gt;

**SINGle**

Each measurement is performed once (regardless of the channel's sweep mode), considering each channels' sweep count, until all measurements in all active channels have been performed.

**CONTInuous**

The measurements in each active channel are performed one after the other, repeatedly (regardless of the channel's sweep mode), in the same order, until the Sequencer is stopped.

**CDEFIned**

First, a single sequence is performed. Then, only those channels in continuous sweep mode (`INIT:CONT ON`) are repeated.

\*RST:       CONTInuous

**Example:**

```
SYST:SEQ ON
```

Activates the Sequencer.

```
INIT:SEQ:MODE SING
```

Sets single Sequencer mode so each active measurement will be performed once.

```
INIT:SEQ:IMM
```

Starts the sequential measurements.

**SYSTem:SEQuencer <State>**

This command turns the Sequencer on and off. The Sequencer must be active before any other Sequencer commands (`INIT:SEQ. . .`) are executed, otherwise an error will occur.

A detailed programming example is provided in the "Operating Modes" chapter in the R&S FSW User Manual.

**Parameters:**

&lt;State&gt;

ON | OFF

**ON**

The Sequencer is activated and a sequential measurement is started immediately.

**OFF**

The Sequencer is deactivated. Any running sequential measurements are stopped. Further Sequencer commands (`INIT:SEQ. . .`) are not available.

\*RST:       OFF

**Example:**

```
SYST:SEQ ON
```

Activates the Sequencer.

```
INIT:SEQ:MODE SING
```

Sets single Sequencer mode so each active measurement will be performed once.

```
INIT:SEQ:IMM
```

Starts the sequential measurements.

```
SYST:SEQ OFF
```

## 10.6 Analysis

General result analysis settings concerning the trace, markers, windows etc. can be configured.

- [Configuring Traces](#).....332
- [Working with Markers](#).....334
- [Configuring Modulation Accuracy Limit Lines](#).....342
- [Zooming into the Display](#).....347

### 10.6.1 Configuring Traces

The trace settings determine how the measured data is analyzed and displayed on the screen. Depending on the result display, between 1 and 6 traces may be displayed.

Manual configuration of traces is described in [chapter 6.1, "Trace Settings"](#), on page 185.



Commands for storing trace data are described in [chapter 10.8.1, "Retrieving Trace Data and Marker Values"](#), on page 361.

**Useful commands for trace configuration described elsewhere:**

- `DISPlay[:WINDow<n>]:TRACe:Y[:SCALE]` on page 293

**Remote commands exclusive to trace configuration:**

<code>CALCulate&lt;n&gt;:TRACe&lt;t&gt;[:VALue]</code> .....	332
<code>DISPlay[:WINDow&lt;n&gt;]:TRACe&lt;t&gt;:MODE</code> .....	333
<code>DISPlay[:WINDow&lt;n&gt;]:TRACe&lt;t&gt;[:STATe]</code> .....	333

#### `CALCulate<n>:TRACe<t>[:VALue] <TrRefType>`

This commands selects the measurement or the reference signal as the data source for a trace.

**Suffix:**

<t> 1..6

**Setting parameters:**

<TrRefType> MEAS | REF

\*RST: The default for trace 1 is always the measurement signal (MEAS). For all other traces, the default signal type depends on the current measurement.

**Usage:** SCPI confirmed

**Manual control:** See ["Evaluation"](#) on page 187

**DISPlay[:WINDow<n>]:TRACe<t>:MODE <Mode>**

This command selects the trace mode.

In case of max hold, min hold or average trace mode, you can set the number of single measurements with `[SENSe:]SWEep:COUNT[:VALue]`. Note that synchronization to the end of the measurement is possible only in single sweep mode. Depending on the result display, not all trace modes may be available.

**Parameters:**

<Mode>

**WRITe**

Overwrite mode: the trace is overwritten by each sweep. This is the default setting.

**AVERAge**

The average is formed over several sweeps. The "Sweep/Average Count" determines the number of averaging procedures.

**MAXHold**

The maximum value is determined over several sweeps and displayed. The R&S FSW saves the sweep result in the trace memory only if the new value is greater than the previous one.

**MINHold**

The minimum value is determined from several measurements and displayed. The R&S FSW saves the sweep result in the trace memory only if the new value is lower than the previous one.

**VIEW**

The current contents of the trace memory are frozen and displayed.

**BLANK**

Hides the selected trace.

\*RST: Trace 1: WRITe, Trace 2-6: BLANK

**Example:**

```
INIT:CONT OFF
```

Switching to single sweep mode.

```
SWE:COUN 16
```

Sets the number of measurements to 16.

```
DISP:TRAC3:MODE WRIT
```

Selects clear/write mode for trace 3.

```
INIT;*WAI
```

Starts the measurement and waits for the end of the measurement.

**Manual control:** See "[Trace Mode](#)" on page 186

**DISPlay[:WINDow<n>]:TRACe<t>[:STATe] <State>**

This command turns a trace on and off.

The measurement continues in the background.

**Example:** `DISP:TRAC3 ON`

<b>Usage:</b>	SCPI confirmed
<b>Manual control:</b>	See " <a href="#">Trace 1/Trace 2/Trace 3/Trace 4/Trace 5/Trace 6</a> " on page 186 See " <a href="#">Trace 1/Trace 2/Trace 3/Trace 4 (Softkeys)</a> " on page 187

## 10.6.2 Working with Markers

Markers help you analyze your measurement results by determining particular values in the diagram. Thus you can extract numeric values from a graphical display.

Manual configuration of markers is described in [chapter 6.3, "Markers"](#), on page 189.

- [Individual Marker Settings](#).....334
- [Marker Search and Positioning Settings](#).....337

### 10.6.2.1 Individual Marker Settings

In VSA evaluations, up to 5 markers can be activated in each diagram at any time.

<a href="#">CALCulate&lt;n&gt;:MARKer&lt;m&gt;:AOFF</a> .....	334
<a href="#">CALCulate&lt;n&gt;:MARKer&lt;m&gt;:LINK</a> .....	334
<a href="#">CALCulate&lt;n&gt;:MARKer&lt;m&gt;[:STATE]</a> .....	335
<a href="#">CALCulate&lt;n&gt;:MARKer&lt;m&gt;:TRACe</a> .....	335
<a href="#">CALCulate&lt;n&gt;:MARKer&lt;m&gt;:X</a> .....	335
<a href="#">CALCulate&lt;n&gt;:DELTAmarker:AOFF</a> .....	335
<a href="#">CALCulate&lt;n&gt;:DELTAmarker&lt;m&gt;[:STATE]</a> .....	336
<a href="#">CALCulate&lt;n&gt;:DELTAmarker&lt;m&gt;:TRACe</a> .....	336
<a href="#">CALCulate&lt;n&gt;:DELTAmarker&lt;m&gt;:X</a> .....	336
<a href="#">CALCulate&lt;n&gt;:DELTAmarker&lt;m&gt;:Y?</a> .....	336

---

#### **CALCulate<n>:MARKer<m>:AOFF**

This command turns all markers off.

**Example:**                    CALC:MARK:AOFF  
                                  Switches off all markers.

**Usage:**                     Event

**Manual control:**        See "[All Markers Off](#)" on page 191

---

#### **CALCulate<n>:MARKer<m>:LINK <MarkerCoupling>**

With this command markers between several screens can be coupled, i.e. use the same stimulus. All screens can be linked with the marker stimulus scaled in symbols or time, except those showing the capture buffer. If several capture buffer measurements are visible, their markers are coupled, too.

**Setting parameters:**

<MarkerCoupling>    ON | OFF  
                          \*RST:        OFF

**Manual control:** See ["Couple Windows"](#) on page 191

---

### **CALCulate<n>:MARKer<m>[:STATE] <State>**

This command turns markers on and off. If the corresponding marker number is currently active as a deltamarker, it is turned into a normal marker.

**Parameters:**

<State> ON | OFF  
\*RST: OFF

**Example:** CALC:MARK3 ON  
Switches on marker 3.

**Manual control:** See ["Marker State"](#) on page 190  
See ["Marker Type"](#) on page 191

---

### **CALCulate<n>:MARKer<m>:TRACe <Trace>**

This command selects the trace the marker is positioned on.

Note that the corresponding trace must have a trace mode other than "Blank".

If necessary, the command activates the marker first.

**Parameters:**

<Trace> **1 to 6**  
Trace number the marker is assigned to.

**Example:** CALC:MARK3:TRAC 2  
Assigns marker 3 to trace 2.

**Manual control:** See ["Assigning the Marker to a Trace"](#) on page 191

---

### **CALCulate<n>:MARKer<m>:X <Position>**

This command moves a marker to a particular coordinate on the x-axis.

If necessary, the command activates the marker.

If the marker has been used as a delta marker, the command turns it into a normal marker.

**Parameters:**

<Position> Numeric value that defines the marker position on the x-axis.  
Range: The range depends on the current x-axis range.

**Example:** CALC:MARK2:X 1.7MHz  
Positions marker 2 to frequency 1.7 MHz.

**Manual control:** See ["Stimulus"](#) on page 190

---

### **CALCulate<n>:DELTAmarker:AOff**

This command turns all delta markers off.

**Example:** `CALC:DELT:AOFF`  
Turns all delta markers off.

**Usage:** Event

#### **CALCulate<n>:DELTamarker<m>[:STATe] <State>**

This command turns delta markers on and off.

If necessary, the command activates the delta marker first.

No suffix at DELTmarker turns on delta marker 1.

**Parameters:**

<State> ON | OFF  
\*RST: OFF

**Example:** `CALC:DELT2 ON`  
Turns on delta marker 2.

**Manual control:** See "[Marker State](#)" on page 190  
See "[Marker Type](#)" on page 191

#### **CALCulate<n>:DELTamarker<m>:TRACe <Trace>**

This command selects the trace a delta marker is positioned on.

Note that the corresponding trace must have a trace mode other than "Blank".

If necessary, the command activates the marker first.

**Parameters:**

<Trace> Trace number the marker is assigned to.

**Example:** `CALC:DELT2:TRAC 2`  
Positions delta marker 2 on trace 2.

#### **CALCulate<n>:DELTamarker<m>:X <Position>**

This command moves a delta marker to a particular coordinate on the x-axis.

If necessary, the command activates the delta marker and positions a reference marker to the peak power.

**Example:** `CALC:DELT:X?`  
Outputs the (absolute) x-value of delta marker 1.

**Manual control:** See "[Stimulus](#)" on page 190

#### **CALCulate<n>:DELTamarker<m>:Y?**

This command moves a marker to a particular coordinate on the x-axis. If necessary, the command activates the marker.



**Return values:**

&lt;Value&gt;

**Usage:** Query only**10.6.2.2 Marker Search and Positioning Settings**

Several functions are available to set the marker to a specific position very quickly and easily. In order to determine the required marker position, searches may be performed. The search results can be influenced by special settings.

Useful commands for positioning markers described elsewhere:

- [CALCulate<n>:MARKer<m>:TRACe](#) on page 335
- [CALCulate<n>:DELTamarker<m>:TRACe](#) on page 336

**Remote commands exclusive to positioning markers:**

<a href="#">CALCulate&lt;n&gt;:DELTamarker&lt;m&gt;:MAXimum:APEak</a> .....	337
<a href="#">CALCulate&lt;n&gt;:DELTamarker&lt;m&gt;:MAXimum:LEFT</a> .....	337
<a href="#">CALCulate&lt;n&gt;:DELTamarker&lt;m&gt;:MAXimum:NEXT</a> .....	338
<a href="#">CALCulate&lt;n&gt;:DELTamarker&lt;m&gt;:MAXimum[:PEAK]</a> .....	338
<a href="#">CALCulate&lt;n&gt;:DELTamarker&lt;m&gt;:MAXimum:RIGHT</a> .....	338
<a href="#">CALCulate&lt;n&gt;:DELTamarker&lt;m&gt;:MINimum:LEFT</a> .....	338
<a href="#">CALCulate&lt;n&gt;:DELTamarker&lt;m&gt;:MINimum:NEXT</a> .....	338
<a href="#">CALCulate&lt;n&gt;:DELTamarker&lt;m&gt;:MINimum[:PEAK]</a> .....	339
<a href="#">CALCulate&lt;n&gt;:DELTamarker&lt;m&gt;:MINimum:RIGHT</a> .....	339
<a href="#">CALCulate&lt;n&gt;:MARKer&lt;m&gt;:MAXimum:APEak</a> .....	339
<a href="#">CALCulate&lt;n&gt;:MARKer&lt;m&gt;:MAXimum:LEFT</a> .....	339
<a href="#">CALCulate&lt;n&gt;:MARKer&lt;m&gt;:MAXimum:NEXT</a> .....	339
<a href="#">CALCulate&lt;n&gt;:MARKer&lt;m&gt;:MAXimum:RIGHT</a> .....	339
<a href="#">CALCulate&lt;n&gt;:MARKer&lt;m&gt;:MAXimum[:PEAK]</a> .....	340
<a href="#">CALCulate&lt;n&gt;:MARKer&lt;m&gt;:MINimum:LEFT</a> .....	340
<a href="#">CALCulate&lt;n&gt;:MARKer&lt;m&gt;:MINimum:NEXT</a> .....	340
<a href="#">CALCulate&lt;n&gt;:MARKer&lt;m&gt;:MINimum:RIGHT</a> .....	340
<a href="#">CALCulate&lt;n&gt;:MARKer&lt;m&gt;:MINimum[:PEAK]</a> .....	340
<a href="#">CALCulate&lt;n&gt;:MARKer:SEARCh</a> .....	341
<a href="#">CALCulate:MARKer:X:SLIMits:LEFT</a> .....	341
<a href="#">CALCulate:MARKer:X:SLIMits:RIGHT</a> .....	341
<a href="#">CALCulate:MARKer:X:SLIMits[:STATE]</a> .....	342

**CALCulate<n>:DELTamarker<m>:MAXimum:APEak**

This command positions the active marker or deltamarker on the largest absolute peak value (maximum or minimum) of the selected trace.

**Usage:** Event**CALCulate<n>:DELTamarker<m>:MAXimum:LEFT**

This command moves a delta marker to the next higher value.

The search includes only measurement values to the left of the current marker position.

**Usage:** Event

**Manual control:** See ["Search Mode for Next Peak"](#) on page 192

---

#### **CALCulate<n>:DELTamarker<m>:MAXimum:NEXT**

This command moves a marker to the next higher value.

**Usage:** Event

**Manual control:** See ["Search Mode for Next Peak"](#) on page 192  
See ["Search Next Peak"](#) on page 193

---

#### **CALCulate<n>:DELTamarker<m>:MAXimum[:PEAK]**

This command moves a delta marker to the highest level.

If the marker hasn't been active yet, the command first activates the marker.

**Usage:** Event

**Manual control:** See ["Peak Search"](#) on page 193

---

#### **CALCulate<n>:DELTamarker<m>:MAXimum:RIGHT**

This command moves a delta marker to the next higher value.

The search includes only measurement values to the right of the current marker position.

**Usage:** Event

**Manual control:** See ["Search Mode for Next Peak"](#) on page 192

---

#### **CALCulate<n>:DELTamarker<m>:MINimum:LEFT**

This command moves a delta marker to the next higher minimum value.

The search includes only measurement values to the right of the current marker position.

**Usage:** Event

**Manual control:** See ["Search Mode for Next Peak"](#) on page 192

---

#### **CALCulate<n>:DELTamarker<m>:MINimum:NEXT**

This command moves a marker to the next higher minimum value.

**Usage:** Event

**Manual control:** See ["Search Mode for Next Peak"](#) on page 192  
See ["Search Next Minimum"](#) on page 194

---

---

**CALCulate<n>:DELTaMarker<m>:MINimum[:PEAK]**

This command moves a delta marker to the minimum level.

If the marker hasn't been active yet, the command first activates the marker.

**Usage:** Event

**Manual control:** See ["Search Minimum"](#) on page 193

---

**CALCulate<n>:DELTaMarker<m>:MINimum:RIGHT**

This command moves a delta marker to the next higher minimum value.

The search includes only measurement values to the right of the current marker position.

**Usage:** Event

**Manual control:** See ["Search Mode for Next Peak"](#) on page 192

---

**CALCulate<n>:MARKer<m>:MAXimum:APEak**

sets the marker to the largest absolute peak value (maximum or minimum) of the selected trace.

**Usage:** Event

**Manual control:** See ["Max |Peak|"](#) on page 193

---

**CALCulate<n>:MARKer<m>:MAXimum:LEFT**

This command moves a marker to the next lower peak.

The search includes only measurement values to the left of the current marker position.

**Usage:** Event

**Manual control:** See ["Search Mode for Next Peak"](#) on page 192

---

**CALCulate<n>:MARKer<m>:MAXimum:NEXT**

This command moves a marker to the next lower peak.

**Usage:** Event

**Manual control:** See ["Search Mode for Next Peak"](#) on page 192  
See ["Search Next Peak"](#) on page 193

---

**CALCulate<n>:MARKer<m>:MAXimum:RIGHT**

This command moves a marker to the next lower peak.

The search includes only measurement values to the right of the current marker position.

**Usage:** Event

**Manual control:** See ["Search Mode for Next Peak"](#) on page 192

---

#### **CALCulate<n>:MARKer<m>:MAXimum[:PEAK]**

This command moves a marker to the highest level.

If the marker hasn't been active yet, the command first activates the marker.

**Usage:** Event

**Manual control:** See ["Peak Search"](#) on page 193

---

#### **CALCulate<n>:MARKer<m>:MINimum:LEFT**

This command moves a marker to the next minimum value.

The search includes only measurement values to the right of the current marker position.

**Usage:** Event

**Manual control:** See ["Search Mode for Next Peak"](#) on page 192

---

#### **CALCulate<n>:MARKer<m>:MINimum:NEXT**

This command moves a marker to the next minimum value.

**Usage:** Event

**Manual control:** See ["Search Mode for Next Peak"](#) on page 192  
See ["Search Next Minimum"](#) on page 194

---

#### **CALCulate<n>:MARKer<m>:MINimum:RIGHT**

This command moves a marker to the next minimum value.

The search includes only measurement values to the right of the current marker position.

**Usage:** Event

**Manual control:** See ["Search Mode for Next Peak"](#) on page 192

---

#### **CALCulate<n>:MARKer<m>:MINimum[:PEAK]**

This command moves a marker to the minimum level.

If the marker hasn't been active yet, the command first activates the marker.

**Usage:** Event

**Manual control:** See ["Search Minimum"](#) on page 193

**CALCulate<n>:MARKer:SEARch <MarkReallmag>**

This command specifies whether the marker search works on the real or the imag trace (for all markers).

**Setting parameters:**

<MarkReallmag> REAL | IMAG  
\*RST: REAL

**Manual control:** See "[Real / Imag Plot](#)" on page 192

**CALCulate:MARKer:X:SLIMits:LEFT <SearchLimit>**

This command defines the left limit of the marker search range.

If you perform a measurement in the time domain, this command limits the range of the trace to be analyzed.

**Parameters:**

<SearchLimit> The value range depends on the span or sweep time.  
The unit is Hz for frequency domain measurements and s for time domain measurements.  
\*RST: left diagram border

<Limit> Range: -1e9 to 1e9  
\*RST: 0.0

**Example:**

```
CALC:MARK:X:SLIM ON
Switches the search limit function on.
CALC:MARK:X:SLIM:LEFT 10MHZ
Sets the left limit of the search range to 10 MHz.
```

**Manual control:** See "[Search Limits \(Left / Right\)](#)" on page 193

**CALCulate:MARKer:X:SLIMits:RIGHT <SearchLimit>**

This command defines the right limit of the marker search range.

If you perform a measurement in the time domain, this command limits the range of the trace to be analyzed.

**Parameters:**

<Limit> The value range depends on the span or sweep time.  
The unit is Hz for frequency domain measurements and s for time domain measurements.  
\*RST: right diagram border

<Limit> Range: -1e9 to 1e9  
\*RST: 800.0

**Example:**

```
CALC:MARK:X:SLIM ON
Switches the search limit function on.
CALC:MARK:X:SLIM:RIGH 20MHZ
Sets the right limit of the search range to 20 MHz.
```

**Manual control:** See ["Search Limits \(Left / Right\)"](#) on page 193

---

#### **CALCulate:MARKer:X:SLIMits[:STATe] <State>**

This command turns marker search limits on and off.

If you perform a measurement in the time domain, this command limits the range of the trace to be analyzed.

**Parameters:**

<State> ON | OFF  
\*RST: OFF

**Example:** CALC:MARK:X:SLIM ON  
Switches on search limitation.

**Manual control:** See ["Search Limits \(Left / Right\)"](#) on page 193

### 10.6.3 Configuring Modulation Accuracy Limit Lines

The results of a modulation accuracy measurement can be checked for violation of defined limits automatically.

Manual configuration of limit lines is described in [chapter 6.4, "Modulation Accuracy Limit Lines"](#), on page 194.

- [General Commands](#).....342
- [Defining Limits](#).....343

#### 10.6.3.1 General Commands

The following commands determine the general behaviour of the limit line check.

CALCulate:LIMit:MACCuracy:DEFault.....342  
CALCulate:LIMit:MACCuracy:STATe.....342

---

#### **CALCulate:LIMit:MACCuracy:DEFault**

Restores the default limits and deactivates all checks in all windows.

**Usage:** Event

**Manual control:** See ["Set to Default"](#) on page 195

---

#### **CALCulate:LIMit:MACCuracy:STATe <LimitState>**

Limits checks for all evaluations based on modulation accuracy (e.g. Result Summary) are enabled or disabled.

**Setting parameters:**

<LimitState> ON | OFF  
\*RST: OFF

**Manual control:** See ["Checking Modulation Accuracy Limits"](#) on page 195

### 10.6.3.2 Defining Limits

The following commands are required to define limits for specific results.

---

```

CALCulate<n>:LIMit:MACCuracy:CFERror:CURRent:STATe <LimitState>
CALCulate<n>:LIMit:MACCuracy:CFERror:MEAN:STATe <LimitState>
CALCulate<n>:LIMit:MACCuracy:CFERror:PEAK:STATe <LimitState>
CALCulate<n>:LIMit:MACCuracy:EVM:PCURrent:STATe <LimitState>
CALCulate<n>:LIMit:MACCuracy:EVM:PMEan:STATe <LimitState>
CALCulate<n>:LIMit:MACCuracy:EVM:PPEak:STATe <LimitState>
CALCulate<n>:LIMit:MACCuracy:EVM:RCURrent:STATe <LimitState>
CALCulate<n>:LIMit:MACCuracy:EVM:RMEan:STATe <LimitState>
CALCulate<n>:LIMit:MACCuracy:EVM:RPEak:STATe <LimitState>
CALCulate<n>:LIMit:MACCuracy:FDERror:CURRent:STATe <LimitState>
CALCulate<n>:LIMit:MACCuracy:FDERror:MEAN:STATe <LimitState>
CALCulate<n>:LIMit:MACCuracy:FDERror:PEAK:STATe <LimitState>
CALCulate<n>:LIMit:MACCuracy:FERRor:PCURrent:STATe <LimitState>
CALCulate<n>:LIMit:MACCuracy:FERRor:PMEan:STATe <LimitState>
CALCulate<n>:LIMit:MACCuracy:FERRor:PPEak:STATe <LimitState>
CALCulate<n>:LIMit:MACCuracy:FERRor:RCURrent:STATe <LimitState>
CALCulate<n>:LIMit:MACCuracy:FERRor:RMEan:STATe <LimitState>
CALCulate<n>:LIMit:MACCuracy:FERRor:RPEak:STATe <LimitState>
CALCulate<n>:LIMit:MACCuracy:MERRor:PCURrent:STATe <LimitState>
CALCulate<n>:LIMit:MACCuracy:MERRor:PMEan:STATe <LimitState>
CALCulate<n>:LIMit:MACCuracy:MERRor:PPEak:STATe <LimitState>
CALCulate<n>:LIMit:MACCuracy:MERRor:RCURrent:STATe <LimitState>
CALCulate<n>:LIMit:MACCuracy:MERRor:RMEan:STATe <LimitState>
CALCulate<n>:LIMit:MACCuracy:MERRor:RPEak:STATe <LimitState>
CALCulate<n>:LIMit:MACCuracy:OOFfset:CURRent:STATe <LimitState>
CALCulate<n>:LIMit:MACCuracy:OOFfset:MEAN:STATe <LimitState>
CALCulate<n>:LIMit:MACCuracy:OOFfset:PEAK:STATe <LimitState>
CALCulate<n>:LIMit:MACCuracy:PERRor:PCURrent:STATe <LimitState>
CALCulate<n>:LIMit:MACCuracy:PERRor:PMEan:STATe <LimitState>
CALCulate<n>:LIMit:MACCuracy:PERRor:PPEak:STATe <LimitState>
CALCulate<n>:LIMit:MACCuracy:PERRor:RCURrent:STATe <LimitState>
CALCulate<n>:LIMit:MACCuracy:PERRor:RMEan:STATe <LimitState>
CALCulate<n>:LIMit:MACCuracy:PERRor:RPEak:STATe <LimitState>
CALCulate<n>:LIMit:MACCuracy:RHO:CURRent:STATe <LimitState>
CALCulate<n>:LIMit:MACCuracy:RHO:MEAN:STATe <LimitState>
CALCulate<n>:LIMit:MACCuracy:RHO:PEAK:STATe <LimitState>
CALCulate<n>:LIMit:MACCuracy:<ResultType>:<LimitType>:STATe <LimitState>

```

This command switches the limit check for the selected result type and limit type on or off.

**Suffix:**

<ResultType> CFERror = Carrier Frequency Error  
 EVM = Error Vector Magnitude  
 FERRor = Frequency error (FSK only)  
 FDERror = Frequency deviation error (FSK only)  
 MERRor = Magnitude Error  
 OOFFset = I/Q Offset  
 PERRor = Phase Error  
 RHO = Rho

## &lt;LimitType&gt;

**For CFERror, OOFFset, RHO:**

CURRent  
 MEAN  
 PEAK

**For EVM, FERRor, MERRor, PERRor:**

PCURRent = Peak current value  
 PMEan = Peak mean value  
 PPEak = Peak peak value  
 RCURRent = RMS current value  
 RMEan = RMS mean value  
 RPEak = RMS peak value

**Setting parameters:**

<LimitState> ON | OFF  
 Activates a limit check for the selected result and limit type.  
 \*RST: OFF

**Example:**

```
CALC2:FEED 'XTIM:DDEM:MACC'
switch on result summary in screen 2
CALC2:LIM:MACC:CFER:CURR:VAL 100 Hz
define a limit of [-100;100]
CALC2:LIM:MACC:CFER:CURR:STAT ON
switch limit check ON
```

**Manual control:**

See "[Current/Mean/Peak](#)" on page 195  
 See "[Check](#)" on page 196

**CALCulate<n>:LIMit:MACCuracy:CFERror:CURRent:VALue <LimitValue>****CALCulate<n>:LIMit:MACCuracy:CFERror:MEAN:VALue <LimitValue>****CALCulate<n>:LIMit:MACCuracy:CFERror:PEAK:VALue <LimitValue>**

This command defines the limit for the current, peak or mean center frequency error limit. Note that the limits for the current and the peak value are always kept identical.

**Setting parameters:**

<LimitValue> numeric value  
 the value x (x>0) defines the interval [-x; x]  
 Range: 0.0 to 1000000  
 \*RST: 1000.0 (mean: 750.0)  
 Default unit: Hz



---

```

CALCulate<n>:LIMit:MACCuracy:EVM:PCURrent:VALue <LimitValue>
CALCulate<n>:LIMit:MACCuracy:EVM:PMEan:VALue <LimitValue>
CALCulate<n>:LIMit:MACCuracy:EVM:PPEak:VALue <LimitValue>
CALCulate<n>:LIMit:MACCuracy:EVM:RCURrent:VALue <LimitValue>
CALCulate<n>:LIMit:MACCuracy:EVM:RMEan:VALue <LimitValue>
CALCulate<n>:LIMit:MACCuracy:EVM:RPEak:VALue <LimitValue>

```

This command defines the value for the current, peak or mean EVM (peak or RMS) limit. Note that the limits for the current and the peak value are always kept identical.

**Setting parameters:**

```

<LimitValue>      numeric value
                   Range:      0.0 to 100
                   *RST:      1.5
                   Default unit: %

```

---

```

CALCulate<n>:LIMit:MACCuracy:FDERRor:CURRent:VALue <LimitValue>
CALCulate<n>:LIMit:MACCuracy:FDERRor:MEAN:VALue <LimitValue>
CALCulate<n>:LIMit:MACCuracy:FDERRor:PEAK:VALue <LimitValue>

```

This command defines the lower limit for the current, peak or mean center frequency deviation error. Note that the limits for the current and the peak value are always kept identical.

This command is available for FSK modulation only.

**Setting parameters:**

```

<LimitValue>      numeric value
                   Range:      0.0 to 1000000
                   *RST:      1 kHz
                   Default unit: Hz

```

---

```

CALCulate<n>:LIMit:MACCuracy:FERRor:PCURrent:VALue <LimitValue>
CALCulate<n>:LIMit:MACCuracy:FERRor:PMEan:VALue <LimitValue>
CALCulate<n>:LIMit:MACCuracy:FERRor:PPEak:VALue <LimitValue>
CALCulate<n>:LIMit:MACCuracy:FERRor:RCURrent:VALue <LimitValue>
CALCulate<n>:LIMit:MACCuracy:FERRor:RMEan:VALue <LimitValue>
CALCulate<n>:LIMit:MACCuracy:FERRor:RPEak:VALue <LimitValue>

```

This command defines the value for the current, peak or mean frequency error (peak or RMS) limit. Note that the limits for the current and the peak value are always kept identical.

This command is available for FSK modulation only.

**Setting parameters:**

```

<LimitValue>      numeric value
                   the value x (x>0) defines the interval [-x; x]
                   Range:      0.0 to 100
                   *RST:      1.5 (mean: 1.0)
                   Default unit: Hz

```

---

**CALCulate<n>:LIMit:MACCuracy:MERRor:PCURrent:VALue** <LimitValue>  
**CALCulate<n>:LIMit:MACCuracy:MERRor:PMEan:VALue** <LimitValue>  
**CALCulate<n>:LIMit:MACCuracy:MERRor:PPEak:VALue** <LimitValue>  
**CALCulate<n>:LIMit:MACCuracy:MERRor:RCURrent:VALue** <LimitValue>  
**CALCulate<n>:LIMit:MACCuracy:MERRor:RMEan:VALue** <LimitValue>  
**CALCulate<n>:LIMit:MACCuracy:MERRor:RPEak:VALue** <LimitValue>

This command defines the value for the current, peak or mean magnitude error (peak or RMS) limit. Note that the limits for the current and the peak value are always kept identical.

**Setting parameters:**

<LimitValue>            numeric value  
                           the value x (x>0) defines the interval [-x; x]  
 Range:                0.0 to 100  
 \*RST:                1.5  
 Default unit: %

---

**CALCulate<n>:LIMit:MACCuracy:OOFset:CURRent:VALue** <LimitValue>  
**CALCulate<n>:LIMit:MACCuracy:OOFset:MEAN:VALue** <LimitValue>  
**CALCulate<n>:LIMit:MACCuracy:OOFset:PEAK:VALue** <LimitValue>

This command defines the upper limit for the current, peak or mean I/Q offset. Note that the limits for the current and the peak value are always kept identical.

**Setting parameters:**

<LimitValue>            numeric value  
 Range:                -200.0 to 0.0  
 \*RST:                -40.0 (mean: -45.0)  
 Default unit: DB

---

**CALCulate<n>:LIMit:MACCuracy:PERRor:PCURrent:VALue** <LimitValue>  
**CALCulate<n>:LIMit:MACCuracy:PERRor:PMEan:VALue** <LimitValue>  
**CALCulate<n>:LIMit:MACCuracy:PERRor:PPEak:VALue** <LimitValue>  
**CALCulate<n>:LIMit:MACCuracy:PERRor:RCURrent:VALue** <LimitValue>  
**CALCulate<n>:LIMit:MACCuracy:PERRor:RMEan:VALue** <LimitValue>  
**CALCulate<n>:LIMit:MACCuracy:PERRor:RPEak:VALue** <LimitValue>

This command defines the value for the current, peak or mean phase error (peak or RMS) limit. Note that the limits for the current and the peak value are always kept identical.

**Setting parameters:**

<LimitValue>            numeric value  
                           the value x (x>0) defines the interval [-x; x]  
 Range:                0.0 to 360  
 \*RST:                3.5 (RMS: 1.5)  
 Default unit: deg

**CALCulate<n>:LIMit:MACCuracy:RHO:CURRent:VALue <LimitValue>**

**CALCulate<n>:LIMit:MACCuracy:RHO:MEAN:VALue <LimitValue>**

**CALCulate<n>:LIMit:MACCuracy:RHO:PEAK:VALue <LimitValue>**

This command defines the lower limit for the current, peak or mean Rho limit. Note that the limits for the current and the peak value are always kept identical.

**Setting parameters:**

<LimitValue>            numeric value  
                               Range:        0.0 to 1.0  
                               \*RST:        0.999 (mean: 0.9995)  
                               Default unit: NONE

## 10.6.4 Zooming into the Display

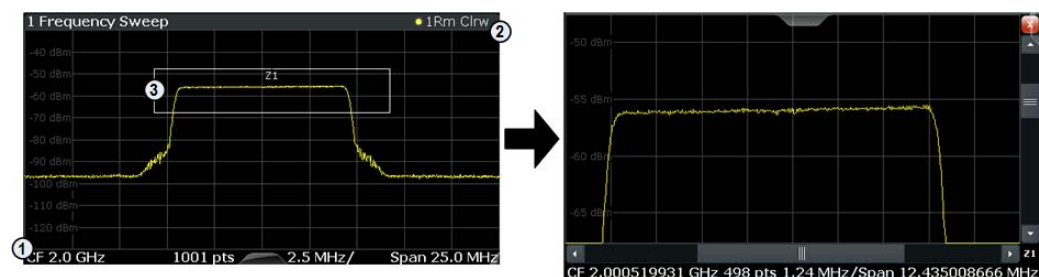
### 10.6.4.1 Using the Single Zoom

DISPlay[:WINDow<n>]:ZOOM:AREA.....347  
 DISPlay[:WINDow<n>]:ZOOM:STATE.....348

**DISPlay[:WINDow<n>]:ZOOM:AREA <x1>,<y1>,<x2>,<y2>**

This command defines the zoom area.

To define a zoom area, you first have to turn the zoom on.



1 = origin of coordinate system (x1 = 0, y1 = 0)  
 2 = end point of system (x2 = 100, y2 = 100)  
 3 = zoom area (e.g. x1 = 60, y1 = 30, x2 = 80, y2 = 75)

**Parameters:**

<x1>,<y1>,  
 <x2>,<y2>            Diagram coordinates in % of the complete diagram that define the zoom area.  
 The lower left corner is the origin of coordinate system. The upper right corner is the end point of the system.

Range:        0 to 100  
 Default unit: PCT

**Manual control:**    See "Single Zoom" on page 200

**DISPlay[:WINDow<n>]:ZOOM:STATe <State>**

This command turns the zoom on and off.

**Parameters:**

<State> ON | OFF  
\*RST: OFF

**Example:**

DISP:ZOOM ON  
Activates the zoom mode.

**Manual control:**

See "Single Zoom" on page 200  
See "Restore Original Display" on page 200  
See "Deactivating Zoom (Selection mode)" on page 200

**10.6.4.2 Using the Multiple Zoom**

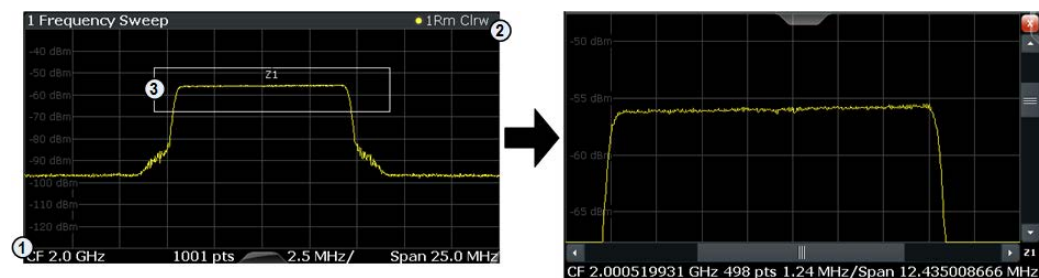
DISPlay[:WINDow<n>]:ZOOM:MULTiple<zoom>:AREA.....348

DISPlay[:WINDow<n>]:ZOOM:MULTiple<zoom>:STATe.....349

**DISPlay[:WINDow<n>]:ZOOM:MULTiple<zoom>:AREA <x1>,<y1>,<x2>,<y2>**

This command defines the zoom area for a multiple zoom.

To define a zoom area, you first have to turn the zoom on.



1 = origin of coordinate system (x1 = 0, y1 = 0)

2 = end point of system (x2 = 100, y2 = 100)

3 = zoom area (e.g. x1 = 60, y1 = 30, x2 = 80, y2 = 75)

**Suffix:**

<zoom> 1...4  
Selects the zoom window.

**Parameters:**

<x1>,<y1>,<x2>,<y2>  
Diagram coordinates in % of the complete diagram that define the zoom area.

The lower left corner is the origin of coordinate system. The upper right corner is the end point of the system.

Range: 0 to 100

Default unit: PCT

**Manual control:**

See "Multiple Zoom" on page 200

**DISPlay[:WINDow<n>]:ZOOM:MULTiple<zoom>:STATe <State>**

This command turns the mutliple zoom on and off.

**Suffix:**

<zoom>                    1...4  
Selects the zoom window.  
If you turn off one of the zoom windows, all subsequent zoom windows move up one position.

**Parameters:**

<State>                    ON | OFF  
\*RST:                    OFF

**Manual control:**        See "[Multiple Zoom](#)" on page 200  
                              See "[Restore Original Display](#)" on page 200  
                              See "[Deactivating Zoom \(Selection mode\)](#)" on page 200

## 10.7 Configuring the Result Display

The following commands are required to configure the result display in a remote environment. The tasks for manual operation are described in [chapter 6.5, "Display and Window Configuration"](#), on page 196.

- [General Window Commands](#).....349
- [Working with Windows in the Display](#).....350
- [VSA Window Configuration](#).....356

### 10.7.1 General Window Commands

The following commands are required to configure general window layout, independant of the application.

Note that the suffix <n> always refers to the window *in the currently selected measurement channel* (see [INSTrument\[:SELEct\]](#) on page 264).

[DISPlay:FORMat](#).....349  
[DISPlay\[:WINDow<n>\]:SIZE](#).....350  
[DISPlay\[:WINDow<n>\]:SELEct](#).....350

**DISPlay:FORMat <Format>**

This command determines which tab is displayed.

**Parameters:**

<Format>                    **SPLit**  
                              Displays the MultiView tab with an overview of all active channels  
                              **SINGle**  
                              Displays the measurement channel that was previously focused.  
\*RST:                    SPL

**Example:**                   DISP:FORM SING

---

### DISPlay[:WINDow<n>]:SIZE <Size>

This command maximizes the size of the selected result display window *temporarily*. To change the size of several windows on the screen permanently, use the LAY:SPL command (see LAYout:SPLitter on page 353).

#### Parameters:

<Size>

#### LARGE

Maximizes the selected window to full screen.  
Other windows are still active in the background.

#### SMALI

Reduces the size of the selected window to its original size.  
If more than one measurement window was displayed originally, these are visible again.

\*RST:       SMALI

**Example:**                   DISP:WIND2:LARG

---

### DISPlay[:WINDow<n>]:SElect

This command sets the focus on the selected result display window.

This window is then the active window.

**Example:**                   DISP:WIND1:SEL  
Sets the window 1 active.

**Usage:**                   Setting only

## 10.7.2 Working with Windows in the Display

The following commands are required to change the evaluation type and rearrange the screen layout for a measurement channel as you do using the SmartGrid in manual operation. Since the available evaluation types depend on the selected application, some parameters for the following commands also depend on the selected measurement channel.

Note that the suffix <n> always refers to the window *in the currently selected measurement channel* (see INSTRument[:SElect] on page 264).

LAYout:ADD[:WINDow]?	351
LAYout:CATalog[:WINDow]?	352
LAYout:IDENtify[:WINDow]?	352
LAYout:REMove[:WINDow]	352
LAYout:REPLace[:WINDow]	353
LAYout:SPLitter	353
LAYout:WINDow<n>:ADD?	355
LAYout:WINDow<n>:IDENtify?	355

<a href="#">LAYout:WINDow&lt;n&gt;:REMove</a> .....	355
<a href="#">LAYout:WINDow&lt;n&gt;:REPLace</a> .....	356
<a href="#">LAYout:WINDow&lt;n&gt;:TYPe?</a> .....	356

---

### **LAYout:ADD[:WINDow]? <WindowName>,<Direction>,<WindowType>**

This command adds a window to the display.

This command is always used as a query so that you immediately obtain the name of the new window as a result.

To replace an existing window, use the [LAYout:REPLace\[:WINDow\]](#) command.

#### **Parameters:**

<b>&lt;WindowName&gt;</b>	String containing the name of the existing window the new window is inserted next to. By default, the name of a window is the same as its index. To determine the name and index of all active windows, use the <a href="#">LAYout:CATalog[:WINDow]?</a> query.
<b>&lt;Direction&gt;</b>	LEFT   RIGHT   ABOVE   BELOW Direction the new window is added relative to the existing window.
<b>&lt;WindowType&gt;</b>	text value Type of result display (evaluation method) you want to add. See the table below for available parameter values.

#### **Return values:**

<b>&lt;NewWindowName&gt;</b>	When adding a new window, the command returns its name (by default the same as its number) as a result.
------------------------------	---

#### **Example:**

```
LAY:ADD? '1',LEFT,MTAB
```

Result:

```
'2'
```

Adds a new window named '2' with a marker table to the left of window 1.

#### **Usage:**

Query only

#### **Manual control:**

See ["Capture Buffer"](#) on page 16  
 See ["Measurement & Reference Signal"](#) on page 16  
 See ["Symbols"](#) on page 17  
 See ["Error Vector"](#) on page 17  
 See ["Modulation Errors"](#) on page 17  
 See ["Modulation Accuracy"](#) on page 18  
 See ["Equalizer"](#) on page 18  
 See ["Signal Source"](#) on page 197

**Table 10-2: <WindowType> parameter values for VSA application**

Parameter value	Data source (+default result display)
CBUffer	Capture buffer (Magnitude absolute)
MEAS	Meas & Ref (Magnitude relative)

Parameter value	Data source (+default result display)
REF	
EQUalizer	Equalizer
EVEctor	Error vector (EVM)
MACCuracy	Modulation Accuracy (Result Summary)
MERRor	Modulation Errors (Magnitude error)
SYMB	Symbols (Hexadecimal)

---

### LAYout:CATalog[:WINDow]?

This command queries the name and index of all active windows from top left to bottom right. The result is a comma-separated list of values for each window, with the syntax:

<WindowName\_1>,<Index\_1>..<WindowName\_n>,<Index\_n>

#### Return values:

<WindowName>      string  
 Name of the window.  
 In the default state, the name of the window is its index.

<Index>            **numeric value**  
 Index of the window.

**Example:**            LAY:CAT?  
 Result:  
 '2',2,'1',1  
 Two windows are displayed, named '2' (at the top or left), and '1' (at the bottom or right).

**Usage:**              Query only

---

### LAYout:IDENTify[:WINDow]? <WindowName>

This command queries the **index** of a particular display window.

**Note:** to query the **name** of a particular window, use the [LAYout:WINDow<n>:IDENTify?](#) query.

#### Query parameters:

<WindowName>      String containing the name of a window.

#### Return values:

<WindowIndex>     Index number of the window.

**Usage:**              Query only

---

### LAYout:REMOve[:WINDow] <WindowName>

This command removes a window from the display.



**Parameters:**

<WindowName> String containing the name of the window.  
In the default state, the name of the window is its index.

**Usage:** Event

**LAYout:REPLace[:WINDow]** <WindowName>,<WindowType>

This command replaces the window type (for example from "Diagram" to "Result Summary") of an already existing window while keeping its position, index and window name.

To add a new window, use the `LAYout:ADD[:WINDow]?` command.

**Parameters:**

<WindowName> String containing the name of the existing window.  
By default, the name of a window is the same as its index. To determine the name and index of all active windows, use the `LAYout:CATalog[:WINDow]?` query.

<WindowType> Type of result display you want to use in the existing window.  
See `LAYout:ADD[:WINDow]?` on page 351 for a list of available window types.

**Example:**

```
LAY:REPL:WIND '1',MTAB
```

Replaces the result display in window 1 with a marker table.

**LAYout:SPLitter** <Index1>,<Index2>,<Position>

This command changes the position of a splitter and thus controls the size of the windows on each side of the splitter.

As opposed to the `DISPlay[:WINDow<n>]:SIZE` on page 350 command, the `LAYout:SPLitter` changes the size of all windows to either side of the splitter permanently, it does not just maximize a single window temporarily.

Note that windows must have a certain minimum size. If the position you define conflicts with the minimum size of any of the affected windows, the command will not work, but does not return an error.

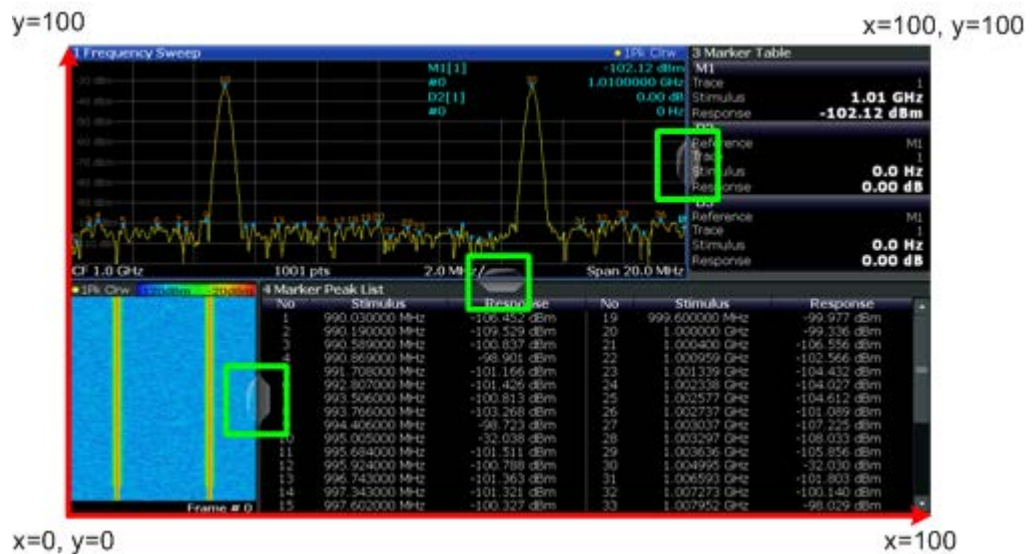


Fig. 10-1: SmartGrid coordinates for remote control of the splitters

**Parameters:**

- <Index1> The index of one window the splitter controls.
- <Index2> The index of a window on the other side of the splitter.
- <Position> New vertical or horizontal position of the splitter as a fraction of the screen area (without channel and status bar and softkey menu). The point of origin ( $x = 0$ ,  $y = 0$ ) is in the lower left corner of the screen. The end point ( $x = 100$ ,  $y = 100$ ) is in the upper right corner of the screen. (See figure 10-1.)
- The direction in which the splitter is moved depends on the screen layout. If the windows are positioned horizontally, the splitter also moves horizontally. If the windows are positioned vertically, the splitter also moves vertically.

Range: 0 to 100

**Example:**

LAY:SPL 1, 3, 50

Moves the splitter between window 1 ('Frequency Sweep') and 3 ('Marker Table') to the center (50%) of the screen, i.e. in the figure above, to the left.

**Example:**

LAY:SPL 1, 4, 70

Moves the splitter between window 1 ('Frequency Sweep') and 3 ('Marker Peak List') towards the top (70%) of the screen. The following commands have the exact same effect, as any combination of windows above and below the splitter moves the splitter vertically.

LAY:SPL 3, 2, 70

LAY:SPL 4, 1, 70

LAY:SPL 2, 1, 70

**LAYout:WINDow<n>:ADD?** <Direction>,<WindowType>

This command adds a measurement window to the display. Note that with this command, as opposed to [LAYout:ADD\[:WINDow\]?](#), the suffix <n> determines the existing window next to which the new window is added.

To replace an existing window, use the [LAYout:WINDow<n>:REPLace](#) command.

This command is always used as a query so that you immediately obtain the name of the new window as a result.

**Parameters:**

<Direction> LEFT | RIGHT | ABOVE | BELOW

<WindowType> Type of measurement window you want to add.  
See [LAYout:ADD\[:WINDow\]?](#) on page 351 for a list of available window types.

**Return values:**

<NewWindowName> When adding a new window, the command returns its name (by default the same as its number) as a result.

**Example:**

```
LAY:WIND1:ADD? LEFT,MTAB
```

Result:

```
'2'
```

Adds a new window named '2' with a marker table to the left of window 1.

**Usage:**

Query only

**LAYout:WINDow<n>:IDENTify?**

This command queries the **name** of a particular display window (indicated by the <n> suffix).

**Note:** to query the **index** of a particular window, use the [LAYout:IDENTify\[:WINDow\]?](#) command.

**Return values:**

<WindowName> String containing the name of a window.  
In the default state, the name of the window is its index.

**Usage:**

Query only

**LAYout:WINDow<n>:REMOve**

This command removes the window specified by the suffix <n> from the display.

The result of this command is identical to the [LAYout:REMOve\[:WINDow\]](#) command.

**Usage:**

Event

**LAYout:WINDow<n>:REPLace <WindowType>**

This command changes the window type of an existing window (specified by the suffix <n>).

The result of this command is identical to the `LAYout:REPLace[:WINDow]` command.

To add a new window, use the `LAYout:WINDow<n>:ADD?` command.

**Parameters:**

<WindowType>      Type of measurement window you want to replace another one with.  
See `LAYout:ADD[:WINDow]?` on page 351 for a list of available window types.

**LAYout:WINDow<n>:TYPE?**

Queries the window type of the window specified by the index <n>. For a list of possible window types see `LAYout:ADD[:WINDow]?` on page 351.

**Example:**            `LAY:WIND2:TYPE?`  
Response:  
MACC  
Modulation accuracy

**Usage:**             Query only

### 10.7.3 VSA Window Configuration

For each window you can select a different evaluation method (result type), based on the data source selected in the "Display Configuration". Further window settings are available for some result types.

Manual configuration of VSA windows is described in [chapter 6.5.1, "Window Configuration"](#), on page 197.

Useful commands for configuring the window described elsewhere:

- `LAYout:ADD[:WINDow]?` on page 351

**Remote commands exclusive to configuring VSA windows:**

<code>CALCulate&lt;n&gt;:DDEM:SPECTrum[:STATe]</code> .....	357
<code>CALCulate&lt;n&gt;:FORMat</code> .....	357
<code>CALCulate&lt;n&gt;:STATistics:CCDF[:STATe]</code> .....	358
<code>CALCulate&lt;n&gt;:STATistics:MODE</code> .....	359
<code>DISPlay[:WINDow&lt;n&gt;]:PRATe:AUTO</code> .....	359
<code>DISPlay[:WINDow&lt;n&gt;]:PRATe:VALue</code> .....	359
<code>DISPlay[:WINDow&lt;n&gt;]:TRACe:SYMBol</code> .....	360
<code>DISPlay[:WINDow&lt;n&gt;]:TRACe:Y[:SCALE]:MODE</code> .....	360

---

**CALCulate<n>:DDEM:SPECTrum[:STATe] <AddEvaluation>**

This command switches the result type transformation to spectrum mode. Spectral evaluation is available for the following result parameters:

- MAGNitude
- PHASe/UPHase
- FREQuency
- Real/Imag (RIMAG)

The result parameters are defined using the CALC:FORM command (see [CALCulate<n>:FORMat](#) on page 357).

**Setting parameters:**

<AddEvaluation>    ON | OFF  
                          \*RST:        Off

**Manual control:**    See "[Result Type Transformation](#)" on page 197

---

**CALCulate<n>:FORMat <Format>**

This command defines the result type of the traces. Which parameters are available depends on the setting for the data source (see [LAYout:ADD\[:WINDow\]?](#) on page 351 and [table 3-1](#)).

Whether the result type shows absolute or relative values is defined using the `DISP:WIND:TRAC:Y:MODE` command (see [DISPlay\[:WINDow<n>\]:TRACe:Y\[:SCALE\]:MODE](#) on page 360).

**Setting parameters:**

<Format>    MAGNitude | PHASe | UPHase | RIMag | FREQuency | COMP |  
 CONS | IEYE | QEYE | FEYE | CONF | COVF | RCONstellation |  
 RSUMmary | BERate | GDELay | NONE

**MAGNitude**  
 Magnitude Absolute

**PHASe**  
 Phase Wrap

**UPHase**  
 Phase Unwrap

**RIMag**  
 Real/Imag (I/Q)

**FREQuency**  
 Frequency Absolute

**COMP**  
 Vector I/Q

**CONS**  
 Constellation I/Q

**IEYE**  
 Eye Diagram Real (I)

**QEYE**  
 Eye Diagram Imag (Q)

**FEYE**  
 Eye Diagram Frequency

**CONF**  
 Constellation Frequency

**COVF**  
 Vector Frequency

**RCONstellation**  
 Constellation I/Q (Rotated)

**RSUMmary**  
 Result summary

**BERate**  
 Bit error rate

**GDELay**  
 Group delay

**Manual control:**    See "[Result Type](#)" on page 197

---

**CALCulate<n>:STATistics:CCDF[:STATe] <AddEvaluation>**

This command switches the measurement of the statistical distribution of magnitude, phase or frequency values on or off.

**Setting parameters:**

<AddEvaluation> ON | OFF  
 \*RST: OFF

**Manual control:** See "[Result Type Transformation](#)" on page 197

**CALCulate<n>:STATistics:MODE <StatisticMode>**

This command defines whether only the symbol points or all points are considered for the statistical calculations.

**Setting parameters:**

<StatisticMode> SONLy | INFinite  
**SONLy**  
 Symbol points only are used  
**INFinite**  
 All points are used  
 \*RST: SONLy

**Manual control:** See "[Oversampling](#)" on page 198

**DISPlay[:WINDow<n>]:PRATe:AUTO <DisplayPPSMODE>**

Defines the number of display points that are displayed per symbol automatically, i.e. according to [\[SENSe:\]DDEMod:PRATe](#) on page 296. To define a different number of points per symbol for display, use the `MANual` parameter and the [DISPlay\[:WINDow<n>\]:PRATe\[:VALue\]](#) command.

**Setting parameters:**

<DisplayPPSMODE> AUTO | MANual  
 \*RST: AUTO

**Manual control:** See "[Display Points/Sym](#)" on page 198

**DISPlay[:WINDow<n>]:PRATe[:VALue] <DisplayPPS>**

This command determines the number of points to be displayed per symbol if manual mode is selected (see [DISPlay\[:WINDow<n>\]:PRATe:AUTO](#) on page 359).

This command is not available for result displays based on the capture buffer; in this case, the displayed points per symbol are defined by the sample rate ([\[SENSe:\]DDEMod:PRATe](#) command).

**Setting parameters:**

<DisplayPPS> 1, 2, 4, 8, 16 or 32  
**1**  
 only the symbol time instants are displayed  
**2, 4, 8, 16, 32**  
 more points are displayed than symbols  
 \*RST: 4

**Manual control:** See ["Display Points/Sym"](#) on page 198

**DISPlay[:WINDow<n>]:TRACe:SYMBOL**

This command enables the display of the decision instants (time when the signals occurred) as dots on the trace.

**Manual control:** See ["Highlight Symbols"](#) on page 198

**DISPlay[:WINDow<n>]:TRACe:Y[:SCALE]:MODE <Mode>**

This command selects the type of scaling of the y-axis.

When the display update during remote control is off, this command has no immediate effect.

**Parameters:**

<Mode> **ABSolute**  
 absolute scaling of the y-axis  
**RELative**  
 relative scaling of the y-axis  
 \*RST: ABSolute

**Example:** DISP:TRAC:Y:MODE REL

## 10.8 Retrieving Results

The following commands are required to retrieve the calculated VSA parameters.



All results that are not based on the capture buffer data are calculated for a single result range only (see [chapter 4.6.1, "Result Range"](#), on page 112). To retrieve the results for several result ranges, use the `[SENSe:]DDEMod:SEARch:MBURst:CALC` on page 303 command to move from one result range to the next.

- [Retrieving Trace Data and Marker Values](#).....361
- [Retrieving Parameter Values](#).....365
- [Retrieving Limit Check Results](#).....375
- [Importing and Exporting I/Q Data and Results](#).....377



### 10.8.1 Retrieving Trace Data and Marker Values

In order to retrieve the trace and marker results in a remote environment, use the following commands:

---

#### **CALCulate<n>:DELTaMarker<m>:X:ABSolute?**

This command queries the absolute x-value of the selected delta marker in the specified window. The command activates the corresponding delta marker, if necessary.

**Usage:** Query only

---

#### **CALCulate<n>:DELTaMarker<m>:X:RELative?**

This command queries the relative position of a delta marker on the x-axis.

If necessary, the command activates the delta marker first.

**Return values:**

<Position> Position of the delta marker in relation to the reference marker or the fixed reference.

**Example:**

```
CALC:DELT3:X:REL?
```

Outputs the frequency of delta marker 3 relative to marker 1 or relative to the reference position.

**Usage:** Query only

---

#### **CALCulate<n>:MARKer<m>:Y?**

This command queries the position of a marker on the y-axis.

If necessary, the command activates the marker first.

To get a valid result, you have to perform a complete measurement with synchronization to the end of the measurement before reading out the result. This is only possible for single sweeps. See also [INITiate:CONTinuous](#) on page 327.

**Return values:**

<Result> Result at the marker position.

**Example:**

```
INIT:CONT OFF
```

Switches to single measurement mode.

```
CALC:MARK2 ON
```

Switches marker 2.

```
INIT;*WAI
```

Starts a measurement and waits for the end.

```
CALC:MARK2:Y?
```

Outputs the measured value of marker 2.

**Usage:** Query only

**DISPlay[:WINDow<n>]:TRACe<t>:X[:SCALe]:START?**

This command queries the first value of the x-axis in symbols or time, depending on the unit setting for the x-axis.

**Note:** using the `CALCulate<n>:TRACe<t>:ADJust:ALIGNment:OFFSet` command, the burst is shifted in the diagram; the x-axis thus no longer begins on the left at 0 symbols but at a selectable value.

**Usage:** Query only

**FORMat:DEXPort:DSEParator <Separator>**

This command selects the decimal separator for data exported in ASCII format.

**Parameters:**

<Separator>

**COMMa**

Uses a comma as decimal separator, e.g. *4,05*.

**POINt**

Uses a point as decimal separator, e.g. *4.05*.

\*RST: \*RST has no effect on the decimal separator. Default is POINT.

**Example:**

FORM:DEXP:DSEP POIN

Sets the decimal point as separator.

**Manual control:** See "[Decimal Separator](#)" on page 189

**FORMat:DEXPort:HEADer <Header>**

This command defines if a file header (including start frequency, sweep time, detector, etc.) is created or not. A small header with the instrument model, the version and the date is always transferred.

**Setting parameters:**

<Header>

ON | OFF

\*RST: OFF

**Manual control:** See "[Header](#)" on page 188

**FORMat:DEXPort:MODE <Mode>**

This command defines which data are transferred, raw I/Q data or trace data.

**Setting parameters:**

<Mode>

RAW | TRACe

\*RST: TRACe

**Manual control:** See "[Data Export Mode](#)" on page 188

**MMEMory:STORe<n>:TRACe** <Trace>, <FileName>

This command exports trace data from the specified window to an ASCII file.

**Parameters:**

<Trace>	Number of the trace to be stored
<FileName>	String containing the path and name of the target file.

**Example:**

```
MMEM:STOR1:TRAC 3, 'TEST.ASC'
```

Stores trace 3 from window 1 in the file TEST.ASC.

**Usage:**

SCPI confirmed

**Manual control:**

See "[Trace ASCII Export](#)" on page 189

**TRACe<n>[:DATA]** <Trace>

This command queries the trace data.

Which data is returned depends on the result display in the window specified by the suffix <n>.

- Capture Buffer
 

For the Capture Buffer result display, the command returns the y-axis values of the data that is stored in the capture buffer. The number of returned values depends on the size of the capture buffer and the sample rate. For example, a capture buffer of 500 in combination with an sample rate of 4 would return 2000 level values. The unit is dBm.
- Cartesian diagrams
 

For cartesian diagrams, the command returns the y-values of the trace only (magnitude, phase, frequency, real/imag, eye diagrams). The number of returned values is the product of the "Result Length" and the display points per symbol. The unit depends on the unit you have set previously. You can query the x-value that relates to the first value of the y-axis using `DISPlay[:WINDow<n>]:TRACe<t>:X[:SCALE]:START?` on page 362.

When querying the results for eye diagrams, the results are merely superimposed in the display. This means that the eye diagram result displays are the same as the real/imag result display.
- Polar diagrams
 

For polar diagrams, the command returns a pair of values for each trace point. The first value is the real part, the second value the imaginary part. The number of returned value pairs depends on the result type:

  - Vector I/Q:
 

evaluation range length \* display points per symbol
  - Constellation I/Q:
 

evaluation range length
  - Constellation Frequency and Vector Frequency: one value for each trace point on the y-axis
- Symbols

For the symbol table result diagrams, the command returns one value for each number in the table. The command always returns the values in the decimal format. The number of returned values depends on the modulation scheme you have selected.

- Eye diagram

For eye diagrams, the command returns one value for each sample. The number of returned values is the product of evaluation range length and display points per symbol.

- Result Summary

For the Result Summary, the command returns all values listed in the result table from top to bottom, i.e.:

<EVM\_RMS>, <EVM\_Peak>, <MER\_RMS>, <MER\_Peak>, <Phase Error RMS>, <Phase Error Peak>, <MagError\_RMS>, <MagError\_Peak>, <Carrier Frequency Error>, <Rho>, <I/Q Offset>, <I/Q Imbalance>, <Gain Imbalance>, <Quadrature Error>, <Amplitude Droop>, <Power>, <**Symbol Rate Error**>

(Note that the "Symbol Rate Error" was appended at the end to provide compatibility to previous versions and instruments.)

For each result type, both the current and statistical values are provided. The order of the results is as follows:

<result1\_current>, <result1\_mean>, <result1\_peak>, <result1\_stddev>, <result1\_95%ile>, <result2\_current>, <result2\_mean>, (...)

Empty cells in the table return nothing. The number of returned values depends on the modulation scheme you have selected. PSK, MSK and QAM modulation returns 85 values, FSK modulation returns 55 values. The unit of each value depends on the particular result.

- Equalizer

For Equalizer diagrams, the command returns the y-axis values of the equalizer trace. The number of returned values depends on the result type:

- For impulse response diagrams:  
(filter length \* sample rate) + 1
- For frequency response, channel and group delay diagrams: 4096 values

You can query the x-value that relates to the first value of the y-axis using

`DISPlay[:WINDow<n>]:TRACe<t>:X[:SCALE]:START?` on page 362.

#### Setting parameters:

<Trace> TRACe1 | TRACe2 | TRACe3 | TRACe4 | TRACe5 | TRACe6 | TRACe1R | TRACe1I | TRACe2R | TRACe2I | TRACe3R | TRACe3I

#### **TRACe1/2/3/4/5/6**

The complete data from the corresponding trace.

#### **TRACe1R/TRACe2R/TRACe3R**

The real data from the corresponding trace. The parameters are available for the Real/Imaginary result types.

#### **TRACe1I/TRACe2I/TRACe3I**

The imaginary data from the corresponding trace. The parameters are available for the Real/Imaginary result types.

## 10.8.2 Retrieving Parameter Values

For each parameter, the VSA application calculates and shows various statistical values:

- Current value
- Mean value  
Calculated as the average of the number of results defined by the [Statistic Count](#).
- Peak value
- Standard deviation
- 95 percentile  
Unlike the mean value, the 95%ile is a result of all measurement results since the last start of a single or continuous sweep, or of all measurements since the last change of a measurement parameter.

For details on the individual parameters see [chapter 3.3, "Common Parameters in VSA"](#), on page 48 and [chapter A.5, "Formulae"](#), on page 410.

<a href="#">CALCulate&lt;n&gt;:BERate</a> .....	365
<a href="#">CALCulate&lt;n&gt;:MARKer&lt;m&gt;:FUNcTion:DDEMod:STATistic:ADRoop?</a> .....	366
<a href="#">CALCulate&lt;n&gt;:MARKer&lt;m&gt;:FUNcTion:DDEMod:STATistic:ALL?</a> .....	366
<a href="#">CALCulate&lt;n&gt;:MARKer&lt;m&gt;:FUNcTion:DDEMod:STATistic:CFERror?</a> .....	366
<a href="#">CALCulate&lt;n&gt;:MARKer&lt;m&gt;:FUNcTion:DDEMod:STATistic:EVM?</a> .....	367
<a href="#">CALCulate&lt;n&gt;:MARKer&lt;m&gt;:FUNcTion:DDEMod:STATistic:FDERror?</a> .....	368
<a href="#">CALCulate&lt;n&gt;:MARKer&lt;m&gt;:FUNcTion:DDEMod:STATistic:FSK:CFDRift?</a> .....	368
<a href="#">CALCulate&lt;n&gt;:MARKer&lt;m&gt;:FUNcTion:DDEMod:STATistic:FSK:DERRor?</a> .....	368
<a href="#">CALCulate&lt;n&gt;:MARKer&lt;m&gt;:FUNcTion:DDEMod:STATistic:FSK:MDEViation?</a> .....	369
<a href="#">CALCulate&lt;n&gt;:MARKer&lt;m&gt;:FUNcTion:DDEMod:STATistic:FSK:RDEViation?</a> .....	370
<a href="#">CALCulate&lt;n&gt;:MARKer&lt;m&gt;:FUNcTion:DDEMod:STATistic:GIMBalance?</a> .....	370
<a href="#">CALCulate&lt;n&gt;:MARKer&lt;m&gt;:FUNcTion:DDEMod:STATistic:IQIMbalance?</a> .....	370
<a href="#">CALCulate&lt;n&gt;:MARKer&lt;m&gt;:FUNcTion:DDEMod:STATistic:MERRor?</a> .....	371
<a href="#">CALCulate&lt;n&gt;:MARKer&lt;m&gt;:FUNcTion:DDEMod:STATistic:MPoWer?</a> .....	371
<a href="#">CALCulate&lt;n&gt;:MARKer&lt;m&gt;:FUNcTion:DDEMod:STATistic:OOFFset?</a> .....	372
<a href="#">CALCulate&lt;n&gt;:MARKer&lt;m&gt;:FUNcTion:DDEMod:STATistic:PERRor?</a> .....	372
<a href="#">CALCulate&lt;n&gt;:MARKer&lt;m&gt;:FUNcTion:DDEMod:STATistic:QERRor?</a> .....	373
<a href="#">CALCulate&lt;n&gt;:MARKer&lt;m&gt;:FUNcTion:DDEMod:STATistic:RHO?</a> .....	374
<a href="#">CALCulate&lt;n&gt;:MARKer&lt;m&gt;:FUNcTion:DDEMod:STATistic:SNR?</a> .....	374
<a href="#">CALCulate&lt;n&gt;:MARKer&lt;m&gt;:FUNcTion:DDEMod:STATistic:SRERror?</a> .....	375

---

### **CALCulate<n>:BERate** <Format>

Queries the Bit Error Rate results. The available results are described in [chapter 3.2.23, "Bit Error Rate \(BER\)"](#), on page 42.

#### **Query parameters:**

<Format> Specifies a particular BER result to be queried. If no parameter is specified, the current bit error rate is returned.  
The parameters for these results are listed in [table 10-3](#).



**Query parameters:**

<type>                   <none>  
 Carrier frequency error for current sweep

**AVG**  
 Average carrier frequency error (over several sweeps)

**RPE**  
 Peak carrier frequency error (over several sweeps)

**SDEV**  
 Standard deviation of frequency error

**PCTL**  
 95 percentile value of frequency error

\*RST:           PEAK

**Usage:**                   Query only

**CALCulate<n>:MARKer<m>:FUNCTION:DDEMod:STATistic:EVM? <type>**

This command queries the results of the error vector magnitude measurement of digital demodulation. The output values are the same as those provided in the Modulation Accuracy table .

**Query parameters:**

<type>                   <none>  
 Average EVM value of current sweep

**AVG**  
 RMS average EVM value (over several sweeps)

**RPE**  
 Peak value of EVM (over several sweeps)

**SDEV**  
 Standard deviation of EVM values over several sweeps

**PCTL**  
 95% percentile of RMS value (over several sweeps)

**PEAK**  
 Maximum EVM over all symbols of current sweep

**PAVG**  
 Average of maximum EVM values over several sweeps

**TPEA**  
 Maximum EVM over all symbols over several sweeps

**PSD**  
 Standard deviation of maximum EVM values over several sweeps

**PPCT**  
 95% percentile of maximum RMS values over several sweeps

\*RST:           PEAK

**Usage:**                   Query only

---

**CALCulate<n>:MARKer<m>:FUNCTION:DDEMod:STATistic:FDERror? <type>**

This command queries the results of the FSK deviation error of FSK modulated signals.

**Query parameters:**

<type>                    **<none>**  
 Deviation error for current sweep.

**AVG**  
 Average FSK deviation error.

**RPE**  
 Peak FSK deviation error.

**SDEV**  
 Standard deviation of FSK deviation error.

**PCTL**  
 95 percentile value of FSK deviation error.

                          \*RST:        PEAK

**Usage:**                    Query only

---

**CALCulate<n>:MARKer<m>:FUNCTION:DDEMod:STATistic:FSK:CFDRift? <type>**

This command queries the results of the carrier frequency drift for FSK modulated signals.

**Query parameters:**

<type>                    **<none>**  
 Carrier frequency drift for current sweep.

**AVG**  
 Average FSK carrier frequency drift.

**RPE**  
 Peak FSK carrier frequency drift.

**SDEV**  
 Standard deviation of FSK carrier frequency drift.

**PCTL**  
 95 percentile value of FSK carrier frequency drift.

                          \*RST:        PEAK

**Usage:**                    Query only

---

**CALCulate<n>:MARKer<m>:FUNCTION:DDEMod:STATistic:FSK:DERRor? <type>**

This command queries the results of the frequency error of FSK modulated signals.



**Query parameters:**

<type>	<b>&lt;none&gt;</b> Frequency error for current sweep.
	<b>AVG</b> Average frequency error (over several sweeps).
	<b>RPE</b> Frequency error (over several sweeps).
	<b>SDEV</b> Standard deviation of frequency error.
	<b>PCTL</b> 95 percentile value of frequency error.
	<b>PEAK</b> Maximum frequency error over all symbols of current sweep.
	<b>PAVG</b> Average of maximum frequency error values over several sweeps.
	<b>TPE</b> Maximum frequency error over all symbols over several sweeps.
	<b>PSD</b> Standard deviation of maximum frequency error values over several sweeps.
	<b>PPCT</b> 95% percentile of maximum RMS values over several sweeps.
	*RST:      PEAK

**Usage:**                    Query only

**CALCulate<n>:MARKer<m>:FUNCTION:DDEMod:STATistic:FSK:MDEVIation?**  
<type>

This command queries the results of the measurement deviation of FSK modulated signals.

**Query parameters:**

<type>	<b>&lt;none&gt;</b> Measurement deviation for current sweep.
	<b>AVG</b> Average FSK measurement deviation.
	<b>RPE</b> Peak FSK measurement deviation.
	<b>SDEV</b> Standard deviation of FSK measurement deviation.
	<b>PCTL</b> 95 percentile value of FSK measurement deviation.
	*RST:      PEAK

**Usage:**                    Query only

---

**CALCulate<n>:MARKer<m>:FUNction:DDEMod:STATistic:FSK:RDEVIation?**  
 <type>

This command queries the results of the reference deviation of FSK modulated signals.

**Query parameters:**

<type>                    **<none>**  
 Measurement deviation for current sweep.

**AVG**  
 Average FSK measurement deviation.

**RPE**  
 Peak FSK measurement deviation.

**SDEV**  
 Standard deviation of FSK measurement deviation.

**PCTL**  
 95 percentile value of FSK measurement deviation.

\*RST:            PEAK

**Usage:**                    Query only

---

**CALCulate<n>:MARKer<m>:FUNction:DDEMod:STATistic:GIMBalance? <type>**

This command queries the results of the Gain Imbalance error measurement of digital demodulation. The output values are the same as those provided in the Modulation Accuracy table .

**Query parameters:**

<type>                    **<none>**  
 Gain imbalance error for current sweep

**AVG**  
 Average gain imbalance error (over several sweeps)

**RPE**  
 Peak gain imbalance error (over several sweeps)

**SDEV**  
 Standard deviation of gain imbalance error

**PCTL**  
 95 percentile value of gain imbalance error

\*RST:            PEAK

**Usage:**                    Query only

---

**CALCulate<n>:MARKer<m>:FUNction:DDEMod:STATistic:IQIMBalance? <type>**

This command queries the results of the I/Q imbalance error measurement of digital demodulation.

**Query parameters:**

<type>                    <none>  
 I/Q imbalance error (for current sweep)

**AVG**  
 Average I/Q imbalance error (over several sweeps)

**RPE**  
 Peak I/Q imbalance error (over several sweeps)

**SDEV**  
 Standard deviation of I/Q imbalance error

**PCTL**  
 95 percentile value of I/Q imbalance error

\*RST:            PEAK

**Usage:**                    Query only

**CALCulate<n>:MARKer<m>:FUNCTION:DDEMod:STATistic:MERRor? <type>**

This command queries the results of the magnitude error measurement of digital demodulation.

**Query parameters:**

<type>                    <none>  
 magnitude error for current sweep

**AVG**  
 Average magnitude error (over several sweeps)

**RPE**  
 Peak magnitude error (over several sweeps)

**SDEV**  
 Standard deviation of magnitude error

**PCTL**  
 95 percentile value of magnitude error

\*RST:            PEAK

**Usage:**                    Query only

**CALCulate<n>:MARKer<m>:FUNCTION:DDEMod:STATistic:MPower? <type>**

This command queries the results of the power measurement of digital demodulation.

**Query parameters:**

<type>                   <none>  
                           power measurement (for current sweep)  
**AVG**  
 Average of power measurement (over several sweeps)  
**RPE**  
 Peak of power measurement (over several sweeps)  
**SDEV**  
 Standard deviation of power measurement  
**PCTL**  
 95 percentile value of power measurement  
 \*RST:           PEAK

**Usage:**                   Query only

**CALCulate<n>:MARKer<m>:FUNctioN:DDEMod:STATistic:OOFFset? <type>**

This command queries the results of the I/Q offset measurement performed for digital demodulation.

**Query parameters:**

<type>                   <none>  
                           Origin offset error (for current sweep)  
**AVG**  
 Average origin offset error (over several sweeps)  
**RPE**  
 Peak origin offset error (over several sweeps)  
**SDEV**  
 Standard deviation of origin offset error  
**PCTL**  
 95 percentile value of origin offset error  
 \*RST:           PEAK

**Usage:**                   Query only

**CALCulate<n>:MARKer<m>:FUNctioN:DDEMod:STATistic:PERRor? <type>**

This command queries the results of the phase error measurement performed for digital demodulation.

**Query parameters:**

<type>	<b>&lt;none&gt;</b> Phase error in degree
	<b>AVG</b> RMS phase error value (over several sweeps)
	<b>RPE</b> Peak value of phase error (over several sweeps)
	<b>SDEV</b> Standard deviation of phase error values over several sweeps
	<b>PCTL</b> 95% percentile of RMS value (over several sweeps)
	<b>PEAK</b> Maximum phase error of current sweep
	<b>PAVG</b> Average of maximum phase error values over several sweeps
	<b>TPE</b> Maximum phase error over several sweeps
	<b>PSD</b> Standard deviation of maximum phase error values over several sweeps
	<b>PPCT</b> 95% percentile of maximum RMS values over several sweeps
	*RST:      PEAK

**Usage:**                    Query only

**CALCulate<n>:MARKer<m>:FUNCTION:DDEMod:STATistic:QERRor? <type>**

This command queries the results of the Quadratur error measurement performed for digital demodulation.

**Query parameters:**

<type>	<b>&lt;none&gt;</b> quadrature error (for current sweep)
	<b>AVG</b> Average quadrature error (over several sweeps)
	<b>RPE</b> Peak quadrature error (over several sweeps)
	<b>SDEV</b> Standard deviation of quadrature error
	<b>PCTL</b> 95 percentile value of quadrature error
	*RST:      PEAK

**Usage:**                    Query only

**CALCulate<n>:MARKer<m>:FUNction:DDEMod:STATistic:RHO? <type>**

This command queries the results of the Rho factor measurement performed for digital demodulation.

**Query parameters:**

<type>	<b>&lt;none&gt;</b> Rho factor (for current sweep)
	<b>AVG</b> Average rho factor (over several sweeps)
	<b>RPE</b> Peak rho factor (over several sweeps)
	<b>SDEV</b> Standard deviation of rho factor
	<b>PCTL</b> 95 percentile value of rho factor
	*RST:      PEAK

**Usage:**                    Query only

**CALCulate<n>:MARKer<m>:FUNction:DDEMod:STATistic:SNR? <type>**

This command queries the results of the SNR error measurement performed for digital demodulation.

**Query parameters:**

<type>	<b>&lt;none&gt;</b> Average SNR value of current sweep
	<b>AVG</b> RMS Average SNR value (over several sweeps)
	<b>RPE</b> Peak value of SNR (over several sweeps)
	<b>SDEV</b> Standard deviation of SNR values over several sweeps
	<b>PCTL</b> 95% percentile of RMS value (over several sweeps)
	<b>PEAK</b> Maximum SNR over all symbols of current sweep
	<b>PAVG</b> Average of maximum SNR values over several sweeps
	<b>TPE</b> Maximum SNR over all symbols over several sweeps
	<b>PSD</b> Standard deviation of maximum SNR values over several sweeps
	<b>PPCT</b> 95% percentile of maximum RMS values over several sweeps
	*RST:      PEAK

**Usage:** Query only

---

**CALCulate<n>:MARKer<m>:FUNction:DDEMod:STATistic:SRERror?**  
 <ResultType>

This command queries the symbol rate error

**Query parameters:**

<ResultType> PEAK | AVG | SDEV | PCTL | TPEak | RPEak | PAVG | PSDev | PPCTI

**<none>**

symbol rate error (for current sweep)

**AVG**

average symbol rate error (over several sweeps)

**RPE**

Peak symbol rate error (over several sweeps)

**SDEV**

Standard deviation of symbol rate error

**PCTL**

95 percentile value of symbol rate error

\*RST: PEAK

**Usage:** Query only

### 10.8.3 Retrieving Limit Check Results

The modulation accuracy parameters can be checked against defined limits. The following commands are required to query the results of these limit checks.

---

**CALCulate<n>:LIMit:MACCuracy:CFERror:CURRent[:RESult]?**  
**CALCulate<n>:LIMit:MACCuracy:CFERror:MEAN[:RESult]?**  
**CALCulate<n>:LIMit:MACCuracy:CFERror:PEAK[:RESult]?**  
**CALCulate<n>:LIMit:MACCuracy:EVM:PCURrent[:RESult]?**  
**CALCulate<n>:LIMit:MACCuracy:EVM:PMEan[:RESult]?**  
**CALCulate<n>:LIMit:MACCuracy:EVM:PPEak[:RESult]?**  
**CALCulate<n>:LIMit:MACCuracy:EVM:RCURrent[:RESult]?**  
**CALCulate<n>:LIMit:MACCuracy:EVM:RMEan[:RESult]?**  
**CALCulate<n>:LIMit:MACCuracy:EVM:RPEak[:RESult]?**  
**CALCulate<n>:LIMit:MACCuracy:FDERror:CURRent[:RESult]?**  
**CALCulate<n>:LIMit:MACCuracy:FDERror:MEAN[:RESult]?**  
**CALCulate<n>:LIMit:MACCuracy:FDERror:PEAK[:RESult]?**  
**CALCulate<n>:LIMit:MACCuracy:FERRor:PCURrent[:RESult]?**  
**CALCulate<n>:LIMit:MACCuracy:FERRor:PMEan[:RESult]?**  
**CALCulate<n>:LIMit:MACCuracy:FERRor:PPEak[:RESult]?**  
**CALCulate<n>:LIMit:MACCuracy:FERRor:RCURrent[:RESult]?**  
**CALCulate<n>:LIMit:MACCuracy:FERRor:RMEan[:RESult]?**  
**CALCulate<n>:LIMit:MACCuracy:FERRor:RPEak[:RESult]?**  
**CALCulate<n>:LIMit:MACCuracy:MERRor:PCURrent[:RESult]?**

CALCulate<n>:LIMit:MACCuracy:MERRor:PMEan[:RESult]?  
 CALCulate<n>:LIMit:MACCuracy:MERRor:PPEak[:RESult]?  
 CALCulate<n>:LIMit:MACCuracy:MERRor:RCURrent[:RESult]?  
 CALCulate<n>:LIMit:MACCuracy:MERRor:RMEan[:RESult]?  
 CALCulate<n>:LIMit:MACCuracy:MERRor:RPEak[:RESult]?  
 CALCulate<n>:LIMit:MACCuracy:OOFfset:CURRent[:RESult]?  
 CALCulate<n>:LIMit:MACCuracy:OOFfset:MEAN[:RESult]?  
 CALCulate<n>:LIMit:MACCuracy:OOFfset:PEAK[:RESult]?  
 CALCulate<n>:LIMit:MACCuracy:PERRor:PCURRent[:RESult]?  
 CALCulate<n>:LIMit:MACCuracy:PERRor:PMEan[:RESult]?  
 CALCulate<n>:LIMit:MACCuracy:PERRor:PPEak[:RESult]?  
 CALCulate<n>:LIMit:MACCuracy:PERRor:RCURRent[:RESult]?  
 CALCulate<n>:LIMit:MACCuracy:PERRor:RMEan[:RESult]?  
 CALCulate<n>:LIMit:MACCuracy:PERRor:RPEak[:RESult]?  
 CALCulate<n>:LIMit:MACCuracy:RHO:CURRent[:RESult]?  
 CALCulate<n>:LIMit:MACCuracy:RHO:MEAN[:RESult]?  
 CALCulate<n>:LIMit:MACCuracy:RHO:PEAK[:RESult]?  
 CALCulate<n>:LIMit:MACCuracy:<ResultType>:<LimitType>[:RESult]

This command queries whether the limit for the specified result type and limit type was violated.

For details on result types and limit types see [chapter 3.2.22, "Result Summary"](#), on page 39.

**Suffix:**

<ResultType> CFERror | EVM | FDERror | FERRor | MERRor | OOFfset | PER-  
 Ror | RHO  
 CFERror = Carrier Frequency Error  
 EVM = Error Vector Magnitude  
 FDERror = Frequency deviation error (FSK only)  
 FERRor = Frequency error (FSK only)  
 MERRor = Magnitude Error  
 OOFfset = I/Q Offset  
 PERRor = Phase Error  
 RHO = Rho

<LimitType> CURRent | MEAN | PEAK | PCURRent | PMEan | PPEak | RCUR-  
 Rent | RMEan | RPEak  
**For CFERror, OOFfset, RHO:**  
 CURRent  
 MEAN  
 PEAK  
**For EVM, FDERror, FERRor, MERRor, PERRor:**  
 PCURRent = Peak current value  
 PMEan = Peak mean value  
 PPEak = Peak peak value  
 RCURRent = RMS current value  
 RMEan = RMS mean value  
 RPEak = RMS peak value



**Return values:**

<LimitResult> NONE | PASS | FAIL | MARGIN

**NONE**  
No limit check result available yet.

**PASS**  
All values have passed the limit check.

**FAIL**  
At least one value has exceeded the limit.

**MARGIN**  
currently not used

\*RST: NONE

**10.8.4 Importing and Exporting I/Q Data and Results**

The I/Q data to be evaluated in VSA can not only be measured by the VSA application itself, it can also be imported to the application, provided it has the correct format. Furthermore, the evaluated I/Q data from the VSA application can be exported for further analysis in external applications.

For details on importing and exporting I/Q data see the R&S FSW User Manual.

MMEMory:LOAD:IQ:STATe.....	377
MMEMory:STORE:IQ:COMMeNt.....	377
MMEMory:STORE:IQ:FORMat?.....	378
MMEMory:STORE:IQ:STATe.....	378

**MMEMory:LOAD:IQ:STATe 1,<FileName>**

This command restores I/Q data from a file.

The file extension is \*.iq.tar.

**Parameters:**

1

<FileName> String containing the path and name of the source file.

**Example:**

```
MMEM:LOAD:IQ:STAT 1, 'C:
\R_S\Instr\user\data.iq.tar'
```

Loads IQ data from the specified file.

**Usage:** Setting only

**MMEMory:STORE:IQ:COMMeNt <Comment>**

This command adds a comment to a file that contains I/Q data.

**Parameters:**

<Comment> String containing the comment.

**Example:**           MMEM:STOR:IQ:COMM 'Device test 1b'  
                           Creates a description for the export file.  
                           MMEM:STOR:IQ:STAT 1, 'C:  
                           \R\_S\Instr\user\data.iq.tar'  
                           Stores I/Q data and the comment to the specified file.

#### **MMEMory:STORe:IQ:FORMat? <Format>,<DataFormat>**

This command queries the format of the I/Q data to be stored.

**Parameters:**

<Format>           **FLOat32**  
                           32-bit floating point format.  
                           \*RST:       FLOat32

<DataFormat>      **COMPLex**  
                           Exports complex data.  
                           \*RST:       COMPLex

**Usage:**            Query only

#### **MMEMory:STORe:IQ:STATe 1, <FileName>**

This command writes the captured I/Q data to a file.

The file extension is \*.iq.tar. By default, the contents of the file are in 32-bit floating point format.

**Parameters:**

1

<FileName>         String containing the path and name of the target file.

**Example:**           MMEM:STOR:IQ:STAT 1, 'C:  
                           \R\_S\Instr\user\data.iq.tar'  
                           Stores the captured I/Q data to the specified file.

## 10.9 Status Reporting System

The status reporting system stores all information on the current operating state of the instrument, e.g. information on errors or limit violations which have occurred. This information is stored in the status registers and in the error queue. The status registers and the error queue can be queried via IEC bus.

In this section, only the status registers/bits specific to the VSA application are described.

For details on the common R&S FSW status registers refer to the description of remote control basics in the R&S FSW User Manual.



\*RST does not influence the status registers.

### Description of the Status Registers

In addition to the registers provided by the base system, the following registers are used in the VSA application:

- `STATUS:QUESTIONABLE:SYNC<n>` - contains application-specific information about synchronization errors or errors during burst detection.
- `STATUS:QUESTIONABLE:MODULATION<n>` – provides information on any limit violations that occur after demodulation in one of the 4 windows
- `STATUS:QUESTIONABLE:MODULATION<n>:EVM` - limit violations in EVM evaluation
- `STATUS:QUESTIONABLE:MODULATION<n>:PHASE` - limit violations in Phase Error evaluation
- `STATUS:QUESTIONABLE:MODULATION<n>:MAGNITUDE` - limit violations in Magnitude Error evaluation
- `STATUS:QUESTIONABLE:MODULATION<n>:CFREQUENCY` - limit violations in Carrier Frequency evaluation
- `STATUS:QUESTIONABLE:MODULATION<n>:IQRHO` - limit violations in I/Q-Offset and RHO evaluation
- `STATUS:QUESTIONABLE:MODULATION<n>:FSK` - limit violations in FSK evaluation



The `STATUS:QUESTIONABLE` register "sums up" the information from all subregisters (e.g. bit 11 sums up the information for all `STATUS:QUESTIONABLE:SYNC` registers). For some subregisters, there may be separate registers for each active channel. Thus, if a status bit in the `STATUS:QUESTIONABLE` register indicates an error, the error may have occurred in any of the channel-specific subregisters. In this case, you must check the subregister of each channel to determine which channel caused the error. By default, querying the status of a subregister always returns the result for the currently selected channel.

The commands to query the contents of the following status registers are described in [chapter 10.9.9, "Querying the Status Registers"](#), on page 384.



### 10.9.1 STATus:QUESTionable:SYNC<n> Register

This register contains application-specific information about synchronization errors or errors during burst detection for each window in each VSA channel. It can be queried with commands `STATus:QUESTionable:SYNC:CONDition?` on page 386 and `STATus:QUESTionable:SYNC[:EVENT]?` on page 386.

*Table 10-4: Status error bits in STATus:QUESTionable:SYNC register for R&S FSW-K70*

Bit	Definition
0	Burst not found. This bit is set if a burst could not be detected.
1	Sync not found This bit is set if the sync sequence (pattern) of the midamble could not be detected.
2 to 14	Not used.
15	This bit is always 0.

### 10.9.2 STATus:QUESTionable:MODulation<n> Register

This register comprises information about any limit violations that may occur after demodulation in any of the VSA windows. It can be queried with commands `STATus:QUESTionable:MODulation<n>:CONDition?` on page 386 and `STATus:QUESTionable:MODulation<n>[:EVENT]?` on page 386.



The status of the `STATus:QUESTionable:MODulation` register is indicated in bit 7 of the "STATus:QUESTionable" register. It can be queried using the `STATus:QUESTionable:EVENT` command.

Bit No	Meaning
0	Error in EVM evaluation
1	Error in Phase Error evaluation
2	Error in Magnitude Error evaluation
3	Error in Carrier Frequency evaluation
4	Error in I/Q offset or RHO evaluation
5	Error in FSK evaluation
6-15	These bits are not used

### 10.9.3 STATus:QUESTionable:MODulation<n>:EVM Register

This register comprises information about limit violations in EVM evaluation. It can be queried with commands

STATus:QUESTionable:MODulation<n>:EVM:CONDition and  
 STATus:QUESTionable:MODulation<n>:EVM[:EVENT].

Bit No	Meaning
0	Error in current RMS value
1	Error in mean RMS value
2	Error in peak RMS value
3-4	These bits are not used
5	Error in current peak value
6	Error in mean peak value
7	Error in peak peak value
8-15	These bits are not used

#### 10.9.4 STATus:QUESTionable:MODulation<n>:PHASe Register

This register comprises information about limit violations in Phase Error evaluation. It can be queried with commands

STATus:QUESTionable:MODulation<n>:PHASe:CONDition and  
 STATus:QUESTionable:MODulation<n>:PHASe[:EVENT].

Bit No	Meaning
0	Error in current RMS value
1	Error in mean RMS value
2	Error in peak RMS value
3-4	These bits are not used
5	Error in current peak value
6	Error in mean peak value
7	Error in peak peak value
8-15	These bits are not used

#### 10.9.5 STATus:QUESTionable:MODulation<n>:MAGNitude Register

This register comprises information about limit violations in Magnitude Error evaluation. It can be queried with commands

STATus:QUESTionable:MODulation<n>:MAGNitude:CONDition and  
 STATus:QUESTionable:MODulation<n>:MAGNitude[:EVENT].

Bit No	Meaning
0	Error in current RMS value
1	Error in mean RMS value
2	Error in peak RMS value
3-4	These bits are not used
5	Error in current peak value
6	Error in mean peak value
7	Error in peak peak value
8-15	These bits are not used

### 10.9.6 STATus:QUESTionable:MODulation<n>:CFRequency Register

This register comprises information about limit violations in Carrier Frequency evaluation. It can be queried with commands

STATus:QUESTionable:MODulation<n>:CFRequency:CONDition and  
STATus:QUESTionable:MODulation<n>:CFRequency[:EVENT].

Bit No	Meaning
0	Error in current value
1	Error in mean value
2	Error in peak value
3-15	These bits are not used

### 10.9.7 STATus:QUESTionable:MODulation<n>:IQRHO Register

This register comprises information about limit violations in I/Q offset or RHO evaluation. It can be queried with commands

STATus:QUESTionable:MODulation<n>:IQRHO:CONDition and  
STATus:QUESTionable:MODulation<n>:IQRHO[:EVENT].

Bit No	Meaning
0	Error in current RHO value
1	Error in mean RHO value
2	Error in peak RHO value
3-4	These bits are not used
5	Error in current I/Q offset value
6	Error in mean I/Q offset value

Bit No	Meaning
7	Error in peak I/Q offset value
8-15	These bits are not used

### 10.9.8 STATus:QUESTionable:MODulation<n>:FSK Register

This register comprises information about limit violations in FSK evaluation. It can be queried with commands

STATus:QUESTionable:MODulation<n>:FSK:CONDition and  
STATus:QUESTionable:MODulation<n>:FSK[:EVENT].

Bit No	Meaning
0	Error in current Frequency Error RMS value
1	Error in mean Frequency Error RMS value
2	Error in peak Frequency Error RMS value
3-4	These bits are not used
5	Error in current Frequency Error peak value
6	Error in mean Frequency Error peak value
7	Error in peak Frequency Error peak value
8-9	These bits are not used
10	Error in current Frequency Deviation value
11	Error in mean Frequency Deviation value
12	Error in peak Frequency Deviation value
13-15	These bits are not used

### 10.9.9 Querying the Status Registers

The following commands query the contents of the individual status registers.

STATus:QUESTionable:ACPLimit:CONDition?	386
STATus:QUESTionable:DIQ:CONDition?	386
STATus:QUESTionable:FREquency:CONDition?	386
STATus:QUESTionable:LIMit<n>:CONDition?	386
STATus:QUESTionable:LMARgin<n>:CONDition?	386
STATus:QUESTionable:MODulation<n>:CONDition?	386
STATus:QUESTionable:MODulation<n>:CFREquency:CONDition?	386
STATus:QUESTionable:MODulation<n>:EVM:CONDition?	386
STATus:QUESTionable:MODulation<n>:FSK:CONDition?	386
STATus:QUESTionable:MODulation<n>:IQRHo:CONDition?	386
STATus:QUESTionable:MODulation<n>:MAGNitude:CONDition?	386
STATus:QUESTionable:MODulation<n>:PHASe:CONDition?	386



STATus:QUESTionable:POWer:CONDition?	386
STATus:QUESTionable:SYNC:CONDition?	386
STATus:QUESTionable:ACPLimit[:EVENT]?	386
STATus:QUESTionable:DIQ[:EVENT]?	386
STATus:QUESTionable:FREQuency[:EVENT]?	386
STATus:QUESTionable:LIMit<n>[:EVENT]?	386
STATus:QUESTionable:LMARgin<n>[:EVENT]?	386
STATus:QUESTionable:MODulation<n>:CFRequency[:EVENT]?	386
STATus:QUESTionable:MODulation<n>:EVM[:EVENT]?	386
STATus:QUESTionable:MODulation<n>:FSK[:EVENT]?	386
STATus:QUESTionable:MODulation<n>:IQRHo[:EVENT]?	386
STATus:QUESTionable:MODulation<n>:MAGNitude[:EVENT]?	386
STATus:QUESTionable:MODulation<n>:PHASe[:EVENT]?	386
STATus:QUESTionable:MODulation<n>[:EVENT]?	386
STATus:QUESTionable:POWer[:EVENT]?	386
STATus:QUESTionable:SYNC[:EVENT]?	386
STATus:QUESTionable:ACPLimit:ENABle	387
STATus:QUESTionable:DIQ:ENABle	387
STATus:QUESTionable:FREQuency:ENABle	387
STATus:QUESTionable:LIMit<n>:ENABle	387
STATus:QUESTionable:LMARgin<n>:ENABle	387
STATus:QUESTionable:MODulation<n>:CFRequency:ENABle	387
STATus:QUESTionable:MODulation<n>:ENABle	387
STATus:QUESTionable:MODulation<n>:EVM:ENABle	387
STATus:QUESTionable:MODulation<n>:FSK:ENABle	387
STATus:QUESTionable:MODulation<n>:IQRHo:ENABle	387
STATus:QUESTionable:MODulation<n>:MAGNitude:ENABle	387
STATus:QUESTionable:MODulation<n>:PHASe:ENABle	387
STATus:QUESTionable:POWer:ENABle	387
STATus:QUESTionable:SYNC:ENABle	387
STATus:QUESTionable:ACPLimit:NTRansition	387
STATus:QUESTionable:DIQ:NTRansition	387
STATus:QUESTionable:FREQuency:NTRansition	387
STATus:QUESTionable:LIMit<n>:NTRansition	387
STATus:QUESTionable:LMARgin<n>:NTRansition	387
STATus:QUESTionable:MODulation<n>:CFRequency:NTRansition	387
STATus:QUESTionable:MODulation<n>:EVM:NTRansition	387
STATus:QUESTionable:MODulation<n>:FSK:NTRansition	387
STATus:QUESTionable:MODulation<n>:IQRHo:NTRansition	387
STATus:QUESTionable:MODulation<n>:MAGNitude:NTRansition	387
STATus:QUESTionable:MODulation<n>:NTRansition	387
STATus:QUESTionable:MODulation<n>:PHASe:NTRansition	387
STATus:QUESTionable:POWer:NTRansition	388
STATus:QUESTionable:SYNC:NTRansition	388
STATus:QUESTionable:ACPLimit:PTRansition	388
STATus:QUESTionable:DIQ:PTRansition	388
STATus:QUESTionable:FREQuency:PTRansition	388
STATus:QUESTionable:LIMit<n>:PTRansition	388
STATus:QUESTionable:LMARgin<n>:PTRansition	388
STATus:QUESTionable:MODulation<n>:CFRequency:PTRansition	388

STATus:QUESTionable:MODulation<n>:EVM:PTRansition.....	388
STATus:QUESTionable:MODulation<n>:FSK:PTRansition.....	388
STATus:QUESTionable:MODulation<n>:IQRHo:PTRansition.....	388
STATus:QUESTionable:MODulation<n>:MAGNitude:PTRansition.....	388
STATus:QUESTionable:MODulation<n>:PHASe:PTRansition.....	388
STATus:QUESTionable:MODulation<n>:PTRansition.....	388
STATus:QUESTionable:POWer:PTRansition.....	388
STATus:QUESTionable:SYNC:PTRansition.....	388

---

**STATus:QUESTionable:ACPLimit:CONDition?**  
**STATus:QUESTionable:DIQ:CONDition?** <Condition>  
**STATus:QUESTionable:FREQuency:CONDition?**  
**STATus:QUESTionable:LIMit<n>:CONDition?**  
**STATus:QUESTionable:LMARgin<n>:CONDition?**  
**STATus:QUESTionable:MODulation<n>:CONDition?**  
**STATus:QUESTionable:MODulation<n>:CFRequency:CONDition?**  
**STATus:QUESTionable:MODulation<n>:EVM:CONDition?**  
**STATus:QUESTionable:MODulation<n>:FSK:CONDition?**  
**STATus:QUESTionable:MODulation<n>:IQRHo:CONDition?**  
**STATus:QUESTionable:MODulation<n>:MAGNitude:CONDition?**  
**STATus:QUESTionable:MODulation<n>:PHASe:CONDition?**  
**STATus:QUESTionable:POWer:CONDition?**  
**STATus:QUESTionable:SYNC:CONDition?** <ChannelName>

This command reads out the CONDition section of the status register.

The command does not delete the contents of the EVENT section.

**Query parameters:**

<ChannelName> String containing the name of the channel.  
 The parameter is optional. If you omit it, the command works for the currently active channel.

**Usage:** Query only

---

**STATus:QUESTionable:ACPLimit[:EVENT]?**  
**STATus:QUESTionable:DIQ[:EVENT]?** <Event>  
**STATus:QUESTionable:FREQuency[:EVENT]?**  
**STATus:QUESTionable:LIMit<n>[:EVENT]?**  
**STATus:QUESTionable:LMARgin<n>[:EVENT]?**  
**STATus:QUESTionable:MODulation<n>:CFRequency[:EVENT]?**  
**STATus:QUESTionable:MODulation<n>:EVM[:EVENT]?**  
**STATus:QUESTionable:MODulation<n>:FSK[:EVENT]?**  
**STATus:QUESTionable:MODulation<n>:IQRHo[:EVENT]?**  
**STATus:QUESTionable:MODulation<n>:MAGNitude[:EVENT]?**  
**STATus:QUESTionable:MODulation<n>:PHASe[:EVENT]?**  
**STATus:QUESTionable:MODulation<n>[:EVENT]?**  
**STATus:QUESTionable:POWer[:EVENT]?**  
**STATus:QUESTionable:SYNC[:EVENT]?** <ChannelName>

This command reads out the EVENT section of the status register.

The command also deletes the contents of the EVENT section.

**Query parameters:**

<ChannelName> String containing the name of the channel.  
The parameter is optional. If you omit it, the command works for the currently active channel.

**Usage:** Query only

**STATus:QUESTionable:ACPLimit:ENABle** <Enable>  
**STATus:QUESTionable:DIQ:ENABle** <Enable>  
**STATus:QUESTionable:FREQuency:ENABle** <Enable>  
**STATus:QUESTionable:LIMit<n>:ENABle** <Enable>  
**STATus:QUESTionable:LMARgin<n>:ENABle** <Enable>  
**STATus:QUESTionable:MODulation<n>:CFREquency:ENABle** <Enable>  
**STATus:QUESTionable:MODulation<n>:ENABle** <Enable>  
**STATus:QUESTionable:MODulation<n>:EVM:ENABle** <Enable>  
**STATus:QUESTionable:MODulation<n>:FSK:ENABle** <Enable>  
**STATus:QUESTionable:MODulation<n>:IQRHo:ENABle** <Enable>  
**STATus:QUESTionable:MODulation<n>:MAGNitude:ENABle** <Enable>  
**STATus:QUESTionable:MODulation<n>:PHASe:ENABle** <Enable>  
**STATus:QUESTionable:POWEr:ENABle** <Enable>  
**STATus:QUESTionable:SYNC:ENABle** <SumBit>,<ChannelName>

This command controls the ENABle part of a register.

The ENABle part allows true conditions in the EVENT part of the status register to be reported in the summary bit. If a bit is 1 in the enable register and its associated event bit transitions to true, a positive transition will occur in the summary bit reported to the next higher level.

**Parameters:**

<SumBit> Range: 0 to 65535  
 <ChannelName> String containing the name of the channel.  
The parameter is optional. If you omit it, the command works for the currently active channel.

**STATus:QUESTionable:ACPLimit:NTRansition** <NTransition>  
**STATus:QUESTionable:DIQ:NTRansition** <NTransition>  
**STATus:QUESTionable:FREQuency:NTRansition** <NTransition>  
**STATus:QUESTionable:LIMit<n>:NTRansition** <NTransition>  
**STATus:QUESTionable:LMARgin<n>:NTRansition** <NTransition>  
**STATus:QUESTionable:MODulation<n>:CFREquency:NTRansition** <NTransition>  
**STATus:QUESTionable:MODulation<n>:EVM:NTRansition** <NTransition>  
**STATus:QUESTionable:MODulation<n>:FSK:NTRansition** <NTransition>  
**STATus:QUESTionable:MODulation<n>:IQRHo:NTRansition** <NTransition>  
**STATus:QUESTionable:MODulation<n>:MAGNitude:NTRansition** <NTransition>  
**STATus:QUESTionable:MODulation<n>:NTRansition** <NTransition>  
**STATus:QUESTionable:MODulation<n>:PHASe:NTRansition** <NTransition>

**STATus:QUESTionable:POWer:NTRansition** <NTransition>

**STATus:QUESTionable:SYNC:NTRansition** <SumBit>, <ChannelName>

This command controls the Negative TRansition part of a register.

Setting a bit causes a 1 to 0 transition in the corresponding bit of the associated register. The transition also writes a 1 into the associated bit of the corresponding EVENT register.

**Parameters:**

<SumBit> Range: 0 to 65535

<ChannelName> String containing the name of the channel.  
The parameter is optional. If you omit it, the command works for the currently active channel.

**STATus:QUESTionable:ACPLimit:PTRansition** <PTransition>

**STATus:QUESTionable:DIQ:PTRansition** <PTranstion>

**STATus:QUESTionable:FREQuency:PTRansition** <PTransition>

**STATus:QUESTionable:LIMit<n>:PTRansition** <PTransition>

**STATus:QUESTionable:LMARgin<n>:PTRansition** <PTransition>

**STATus:QUESTionable:MODulation<n>:CFRequency:PTRansition** <PTransition>

**STATus:QUESTionable:MODulation<n>:EVM:PTRansition** <PTransition>

**STATus:QUESTionable:MODulation<n>:FSK:PTRansition** <PTransition>

**STATus:QUESTionable:MODulation<n>:IQRHo:PTRansition** <PTransition>

**STATus:QUESTionable:MODulation<n>:MAGNitude:PTRansition** <PTransition>

**STATus:QUESTionable:MODulation<n>:PHASe:PTRansition** <PTransition>

**STATus:QUESTionable:MODulation<n>:PTRansition** <PTransition>

**STATus:QUESTionable:POWer:PTRansition** <PTransition>

**STATus:QUESTionable:SYNC:PTRansition** <SumBit>, <ChannelName>

These commands control the Positive TRansition part of a register.

Setting a bit causes a 0 to 1 transition in the corresponding bit of the associated register. The transition also writes a 1 into the associated bit of the corresponding EVENT register.

**Parameters:**

<SumBit> Range: 0 to 65535

<ChannelName> String containing the name of the channel.  
The parameter is optional. If you omit it, the command works for the currently active channel.

## 10.10 Obsolete Commands

The following commands are maintained for compatibility reasons with previous R&S analyzers only. Use the specified alternative commands for new remote control programs.

<a href="#">CALCulate&lt;n&gt;:FEED</a> .....	389
<a href="#">CALCulate&lt;n&gt;:FSK:DEViation:COMPensation</a> .....	389
<a href="#">[SENSe:]DDEMod:EQUalizer:ADAPT</a> .....	390
<a href="#">[SENSe:]DDEMod:NORMAlize[:VALue]</a> .....	390

**CALCulate<n>:FEED <Feed>**

Selects the signal source for evaluation.

Note that this command is maintained for compatibility reasons only. Use the `LAYout` commands for new remote control programs (see [chapter 10.7.2, "Working with Windows in the Display"](#), on page 350).

**Setting parameters:**

<Feed>	string
	<b>'XTIM:DDEM:MEAS'</b> Measured signal
	<b>'XTIM:DDEM:REF'</b> Reference signal
	<b>'XTIM:DDEM:ERR:VECT'</b> Error vector
	<b>'XTIM:DDEM:ERR:MPH'</b> Modulation errors
	<b>'XTIM:DDEM:MACC'</b> Modulation accuracy
	<b>'XTIM:DDEM:SYMB'</b> Symbol table
	<b>'TCAP'</b> Capture Buffer
	<b>'XTIM:DDEM:IMP'</b> Equalizer Impulse Response
	<b>'XFR:DDEM:RAT'</b> Equalizer Frequency Response
	<b>'XFR:DDEM:IRAT'</b> Equalizer Group Delay

**CALCulate<n>:FSK:DEVIation:COMPensation <RefDevComp>**

This command defines whether the deviation error is compensated for when calculating the frequency error for FSK modulation.

Note that this command is maintained for compatibility reasons only. For newer remote programs, use `[SENSe:]DDEMod:NORMAlize:FDErRor` on page 319.

**Setting parameters:**

<RefDevComp>	ON   OFF
	<b>ON</b> Scales the reference signal to the actual deviation of the measurement signal.
	<b>OFF</b> Uses the entered nominal deviation for the reference signal.
	*RST:      ON

**[SENSe:]DDEMod:EQUalizer:ADAPt <Mode>**

This command switches the learning phase of the equalizer on or off.

Note that this command is retained for compatibility reasons only. In newer remote programs, use the [SENS:]DDEMod:EQU:MODE TRAIN command instead (see [SENSe:]DDEMod:EQUalizer:MODE on page 315).

**Setting parameters:**

<Mode>                    ON | OFF  
\*RST:                    OFF

**[SENSe:]DDEMod:NORMalize[:VALue] <Normalize>**

This command switches the compensation of the IQ offset and the compensation of amplitude droop on or off.

Note that this command is maintained for compatibility reasons only. Use the more specific [SENSe:]DDEMod:NORMalize commands for new remote control programs (see chapter 10.4.8, "Demodulation Settings", on page 312).

**Parameters:**

<Normalize>                ON | OFF  
**OFF**  
No compensation for amplitude droop nor I/Q offset  
**ON**  
Compensation for amplitude droop and I/Q offset enabled  
\*RST:                    ON

## 10.11 Programming Examples

The following examples demonstrate how to perform vector signal analysis in a remote environment.

These examples are meant to demonstrate the use of the most common remote commands for vector signal analysis. Note that not all commands executed here are actually necessary, as they may reflect default settings.

- [Measurement Example 1: User-defined Measurement of Continuous QPSK Signal](#) .....391
- [Measurement Example 2: GSM EDGE Burst Measurement Based on a Digital Standard](#).....392
- [Measurement Example 3: User-Defined Pattern Search and Limit Check](#).....396

### 10.11.1 Measurement Example 1: User-defined Measurement of Continuous QPSK Signal

The following example describes a scenario similar to the one for manual operation described in [chapter 8.2, "Measurement Example 1: Continuous QPSK Signal"](#), on page 220.

```
//-----Configuring the measurement -----

*RST
//Reset the instrument
FREQ:CENT 1GHz
//Set the center frequency.
DISP:TRAC:Y:RLEV 4dBm
//Set the reference level
INST:CRE:NEW DDEM, 'MyVSA'
//Create new measurement channel for vector signal analysis named "MyVSA"

//----- Configuring the expected input signal -----

DDEM:FORM QPSK
//Set the modulation type
DDEM:QPSK:FORM NORM
//Set the modulation order
DDEM:MAPP:CAT?
//Query the available symbol mappings for QPSK modulation
DDEM:MAPP 'WCDMA'
//Set the symbol mapping to WCDMA
DDEM:SRAT 1 MHz
//Set the symbol rate
DDEM:TFIL:NAME 'RRC'
DDEM:TFIL:ALPH 0.35
//Select the RRC transmit filter

//----- Configuring an averaged EVM vs Time result display -----

LAY:ADD? '1',RIGH,EVEC
//Create new window to the right of I/Q constellation (window 1) with
//error vector as data type
//Result: '5'
CALC5:FORM MAGN
//Set result type for window 5 to magnitude = EVM
DISPlay:WINDow5:TRACe2:MODE AVER
//Add a second trace in average mode
DISPlay:WINDow5:TRACe3:MODE MAXH
//Add a third trace in max hold mode
SWE:COUN 10
//Calculate an average over 10 sweeps

//-----Performing the measurement-----
```

```

INIT:CONT OFF
//Select single sweep mode.
INIT;*WAI
//Initiate a new measurement and wait until the 10 sweeps have finished.

//-----Storing the Constellation I/Q diagram to a file -----

DISP:WIND1:SIZE LARG
//Display the I/Q Constellation result display (window 1) in full screen.
HCOP:DEST 'MMEM'
//Define the destination of the screenshot as a file.
HCOP:DEV:LANG BMP
//Select bmp as the file format.
MMEM:NAME 'C:\R_S\INST\USER\IQConstellation.bmp'
//Select the file name for the printout.
HCOP:ITEM:ALL
//Print all screen elements
HCOP
//Store the printout in a file called 'IQConstellation.bmp'.
DISP:WIND5:SIZE SMAL
//Restore the I/Q Constellation result display to one subwindow.

//-----Storing the EVM trace data to a file-----

FORM:DEXP:HEAD ON
//Include a header in the trace export file
FORM:DEXP:MODE TRAC
//Export the trace data, not raw I/Q data
MMEM:STOR4:TRAC 1, 'AverageEVM'
//Save the detected symbol values (x-values are not exported with trace data)
//Results:
MMEM:STOR5:TRAC 1, 'AverageEVM'
//Save the EVM values (window 5) to an ascii file.
//Results:
//

```

### 10.11.2 Measurement Example 2: GSM EDGE Burst Measurement Based on a Digital Standard

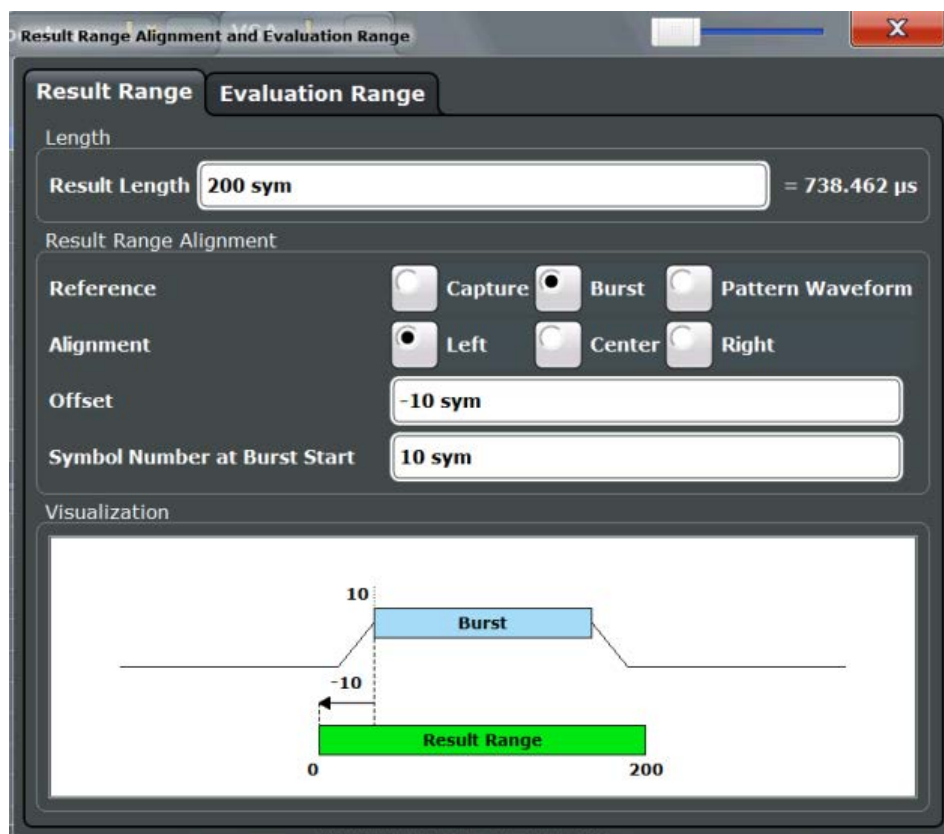
The following example describes a scenario similar to the one for manual operation described in [chapter 8.3, "Measurement Example 2: Burst GSM EDGE Signals"](#), on page 228 [chapter 8.2, "Measurement Example 1: Continuous QPSK Signal"](#), on page 220.





Note that although this example uses the settings from a predefined digital standard, the configuration is changed to demonstrate the possibilities of the VSA application. A measurement that is performed strictly according to the standard requires much less programming efforts.

The rising and falling edges of a GSM burst are analyzed using the following result range settings:



```
//-----Configuring the measurement -----

*RST
//Reset the instrument
FREQ:CENT 1GHz
//Set the center frequency.
DISP:TRAC:Y:RLEV 4dBm
//Set the reference level
INST:CRE:NEW DDEM, 'VSA'
//Create new measurement channel for vector signal analysis named "VSA"

//-----Loading the required digital standard -----

DDEM:PRES 'EDGE_NB'
//Loads the GSM EDGE_8PSK standard file and the settings defined there
```

```

//-----Changing data acquisition settings -----

DDEM:RLEN 10000 sym

//----- Defining the result range -----
DDEMod:TIME 200
//Defines the result length as 200 symbols.
CALC:TRAC:ADJ BURS
//Defines the burst as the reference for the result range
CALC:TRAC:ADJ:ALIG LEFT
//Aligns the result range to the left edge of the burst
CALC:TRAC:ADJ:ALIG:OFFS -10
//Defines an offset of 10 symbols from the burst start
DISP:TRAC:X:VOFF 10
//Defines the symbol number 10 as the result range start

//-----Defining the evaluation range -----

CALC:ELIN:STAT ON
CALC:ELIN1 10
CALC:ELIN2 190
//Evaluation range starts at symbol 10 and ends at symbol 190

//----- Changing the result display -----

LAY:WIND4:REM
//Close symbol table display (window 4)
DISPlay:WINDow1:TRACe2:MODE MAXH
//Add a second trace in max hold mode to EVM vs Time display (window 1)
LAY:ADD? '3',RIGH,MEAS
//Create new window to the right of capture buffer (window 3) with
//measurement signal as data type
//Result: '4'
CALC4:FORM MAGN
//Set result type for window 4 to magnitude
DISPlay:WINDow4:TRACe2:MODE WRIT
CALC4:TRAC2 REF
//Add a second trace in clear/write mode for the reference signal

//----- Activating limit checks for modulation accuracy -----

CALC:LIM:MACC:STAT ON
//Activates limit checks for all values in the Result Summary

//-----Performing the measurement -----

INIT:CONT OFF
//Select single sweep mode.
INIT;*WAI
//Initiate a new measurement and wait until the 10 sweeps have finished.

```

```

//----- Retrieving Results -----

CALC2:MARK:FUNC:DDEM:STAT:EVM? AVG
CALC:LIM:MACC:EVM:RCUR?
//Query the value and check the limit for the EVM RMS value in the
//result summary for the current evaluation range
//Result:
CALC2:MARK:FUNC:DDEM:STAT:EVM? PAVG
CALC:LIM:MACC:EVM:PPE?
//Query the value and check the limit for the largest error vector magnitude
//in the measurement.
//Result:
CALC2:MARK:FUNC:DDEM:STAT:CFER? AVG
CALC:LIM:MACC:CFER:MEAN?
//Query the value and check the limit for the mean carrier frequency offset
//in the result summary for the current evaluation range
//Result:

//----- Storing trace data to a file -----

FORM:DEXP:HEAD ON
//Include a header in the trace export file
FORM:DEXP:MODE TRAC
//Export the trace data, not raw I/Q data
DISP:WIND1:TRAC2:X:STAR?
//Query the first value of the x-axis for the current result range
//(x-values are not exported with trace data)
//Result:
MMEM:STOR4:TRAC 1,'Measurement signal'
//Save the measurement signal values (trace 1 in window 4) to an ascii file.
//Results:
//
MMEM:STOR4:TRAC 2,'Reference signal'
//Save the reference signal values (trace 2 in window 4) to an ascii file.
//Results:
//
MMEM:STOR2:TRAC 1,'Result Summary'
//Save the result summary values (window 2) for the current result range
//to an ascii file.
//Results:
//

//----- Retrieving results for further result ranges ----->

DDEM:SEAR:MBUR:CALC?
//Query the number of result ranges (current is last)
//Use variable <x> to determine number of previous result range
//DDEM:SEAR:MBUR:CALC <x>

```

```
//Move to next result range and repeat section "retrieving results" for
//range-specific results
```

### 10.11.3 Measurement Example 3: User-Defined Pattern Search and Limit Check

In this example a user-defined pattern is used to detect bursts and the calculated measurement results are checked against defined limits. The configuration settings are stored as a user-defined standard.

```
//-----Configuring the measurement -----

*RST
//Reset the instrument
FREQ:CENT 1GHz
//Set the center frequency.
DISP:TRAC:Y:RLEV 4dBm
//Set the reference level
INST:CRE:NEW DDEM,'VSA'
//Create new measurement channel for vector signal analysis named "VSA"

//----- Creating a pattern -----

DDEM:SEAR:SYNC:NAME 'EDGE_TSC_CUST'
//Create new pattern
DDEM:SEAR:SYNC:NST 4
DDEM:SEAR:SYNC:DATA '00030001000000000003000200020001000300010001'
DDEM:SEAR:SYNC:COMM 'Customized pattern'
DDEM:SEAR:SYNC:TEXT 'Special edge normal Burst'
DDEM:SEAR:SYNC:NAME 'EDGE_TSC_CUST'
//Store customized pattern
DDEM:SEAR:SYNC:PATT:ADD 'EDGE_TSC_CUST'
//Add new pattern to current standard

//----- Configuring the expected input signal -----
DDEM:FORM QPSK
//Set the modulation type
DDEM:QPSK:FORM NORM
//Set the modulation order
DDEM:MAPP:CAT?
//Query the available symbol mappings for QPSK modulation
DDEM:MAPP 'WCDMA'
//Set the symbol mapping to WCDMA
DDEM:SRAT 1 MHz
//Set the symbol rate

DDEM:SIGN BURS
//Define input signal as burst signal
DDEM:SIGN:PATT ON
```

```
//Enable pattern search
DDEM:SEAR:SYNC:CAT? CURR
//Query the names of all defined patterns assigned to the current standard
DDEM:SEAR:SYNC:SEL 'EDGE_TSC_CUST'
//Select a pattern
DDEM:STAN:SYNC:OFFS 10
//Ignore the first 10 symbols of the signal before comparing pattern
DDEM:STAN:SYNC:OFFS:STAT ON
DDEM:SEAR:SYNC:STAT ON

//----- Storing the new settings as a user-defined standard -----

DDEM:STAN:SAVE 'C:\TEMP\CustomizedBurstMeas'

//-----Performing the measurement -----

INIT:CONT OFF
//Select single sweep mode.
INIT;*WAI
//Initiate a new measurement and wait until it has finished.

//----- Retrieving Results -----
TRAC3:DATA? TRACE1
//Query the trace results of the capture buffer display.
//Results:
//
TRAC2:DATA? TRACE1
//Query the results of the result summary.
//Results:
//
```

# A Annex

The following sections are provided for reference purposes and include detailed information such as formulae and abbreviations.

• <a href="#">Predefined Standards and Settings</a> .....	398
• <a href="#">Predefined Measurement and Tx Filters</a> .....	404
• <a href="#">ASCII File Export Format for VSA Data</a> .....	406
• <a href="#">Known Data File Syntax Description</a> .....	408
• <a href="#">Formulae</a> .....	410
• <a href="#">Abbreviations</a> .....	424

## A.1 Predefined Standards and Settings

In the "Digital Standards" menu, predefined basic settings for standards can be selected and user-defined standards stored (see [chapter 5.2, "Configuration According to Digital Standards"](#), on page 121).

The most common measurements are predefined as standard settings for a large number of mobile radio networks. The instrument comes prepared with the following settings for those standards:

- Capture length and result length
- Signal description
- Modulation
- Transmit filter and measurement filter
- Burst/Pattern search configuration
- Result range alignment
- Evaluation range settings
- Display configuration

The standard settings are grouped in folders to facilitate selecting a standard.

Table 1-1: List of predefined standards and settings

Folder	Standard (SCPI *)	Modulation Mapping	Symbol rate	Transmit Filter Meas. Filter	Alpha/BT	Search for Burst	Search for Pattern	Pattern	Result length	Alignment	Evaluation Range
GSM	GSM_Nor- malBurst (GSM)	DMSK GSM	270.83333 kHz	GMSK NONE	0.3	✓	✓	GSM_TSC0 (...) GSM_TSC7	148	Pattern to Center	0.5 - 147.25
	GSM_Syn- chroniza- tionBurst (GSM_SB)	DMSK GSM	270.83333 kHz	GMSK NONE	0.3	✓	✓	GSM_SB0 (...) GSM_SB2	148	Pattern to Center	3 - 144
	GSM_Fre- quency- Burst (GSM_FB)	DMSK GSM	270.83333 kHz	GMSK NONE	0.3	✓	✓	GSM_FB0 GSM_FB01	148	Pattern to Center	3 - 144
	GSM_Acce ssBurst (GSM_AB)	DMSK GSM	270.83333 kHz	GMSK NONE	0.3	✓	✓	GSM_AB0 (...) GSM_AB2	88	Pattern to Center	8 - 85
	EDGE_8PS K (EDGE_NB , EDGE_Nor- malburst)	3 $\pi$ /8-8PSK EDGE	270.833 kHz	Linearized GMSK EDGE_NSR	-	✓	✓	EDGE_TSC0 (...) EDGE_TS7	148	Pattern to Center	3-144.75
	EDGE_16Q AM	$\pi$ /4-16QAM EDGE	270.833 kHz	Linearized GMSK EDGE_NSR	-	✓	✓	16QAM_EDGE _TSC0 (...) 16QAM_EDGE _TS7	148	Pattern to Center	3-144.75

\*) The SCPI parameter for remote commands is provided where it differs from the standard name or a short form is available.

Folder	Standard (SCPI *)	Modulation Mapping	Symbol rate	Transmit Filter Meas.Filter	Alpha/BT	Search for Burst	Search for Pattern	Pattern	Result length	Alignment	Evaluation Range
	EDGE_32QAM	$\pi/4$ -32QAM EDGE	270.833 kHz	Linearized GMSK EDGE_NSR	-	✓	✓	32QAM_EDGE_TSC0 (...) 32QAM_EDGE_TS7	148	Pattern to Center	3-144.75
	EDGE_QPSK_HSR_NarrowPulse	$3\pi/4$ -QPSK EDGE	325 kHz	EDGE Narrow Pulse Shape EDGE HSR (Narrow Pulse)	-	✓	✓	EDGE_HSR_Q_PSK_TSC0 (...) EDGE_HSR_Q_PSK_TSC1..7	177	Pattern to Center	4- 172.75
	EDGE_QPSK_HSR_WidePulse	$3\pi/4$ -QPSK EDGE	325 kHz	EDGE Wide Pulse Shape EDGE HSR (Wide Pulse)	-	✓	✓	EDGE_HSR_Q_PSK_TSC0 (...) EDGE_HSR_Q_PSK_TSC1..7	177	Pattern to Center	4- 172.75
	EDGE_16QAM_HSR_NarrowPulse	$\pi/4$ -16QAM EDGE	325 kHz	EDGE Narrow Pulse Shape EDGE HSR (Narrow Pulse)	-	✓	✓	EDGE_HSR_1_6QAM_TSC0 (...) EDGE_HSR_1_6QAM_TSC1..7	177	Pattern to Center	4- 172.75
	EDGE_16QAM_HSR_WidePulse	$\pi/4$ -16QAM EDGE	325 kHz	EDGE Wide Pulse Shape EDGE HSR (Wide Pulse)	-	✓	✓	EDGE_HSR_1_6QAM_TSC0 (...) EDGE_HSR_1_6QAM_TSC1..7	177	Pattern to Center	4- 172.75

\*) The SCPI parameter for remote commands is provided where it differs from the standard name or a short form is available.



## Predefined Standards and Settings

Folder	Standard (SCPI *)	Modulation Mapping	Symbol rate	Transmit Filter Meas.Filter	Alpha/BT	Search for Burst	Search for Pattern	Pattern	Result length	Alignment	Evaluation Range
	EDGE_32Q AM_HSR_ Narrow- Pulse	$-\pi/4$ -32QAM EDGE	325 kHz	EDGE Nar- row Pulse Shape EDGE HSR (Narrow Pulse)	-	✓	✓	EDGE_HSR_3 2QAM_TSC0 (...) EDGE_HSR_3 2QAM_TSC1.. 7	177	Pattern to Center	4- 172.75
	EDGE_32Q AM_HSR_ WidePulse	$-\pi/4$ -32QAM EDGE	325 kHz	EDGE Wide Pulse Shape EDGE HSR (Wide Pulse)	-	✓	✓	EDGE_HSR_3 2QAM_TSC0 (...) EDGE_HSR_3 2QAM_TSC1.. 7	177	Pattern to Center	4- 172.75
TETRA	TETRA_Dis continuous- Downlink (TETRA_N DDOWN)	$\pi/4$ -DQPSK TETRA	18 kHz	RRC RRC	0.35	✓	-	TETRA_S1 ... TETRA_S3	246	Burst to Center	0 - 244
	TETRA_Co ntinuous- Downlink (TETRA_N CDOWN)	$\pi/4$ -DQPSK TETRA	18 kHz	RRC RRC	0.35	✓	-	TETRA_E TETRA_S	255	Burst to Center	0 - 244
3GPP	3G_WCDM A (3G_WCD MA_FWD, 3G_WCDM A_REV)	QPSK WCDMA	3.84 MHz	RRC RRC	0.22	-	-	-	800	Capture/ Left	-

\*) The SCPI parameter for remote commands is provided where it differs from the standard name or a short form is available.

## Predefined Standards and Settings

Folder	Standard (SCPI *)	Modulation Mapping	Symbol rate	Transmit Filter Meas.Filter	Alpha/BT	Search for Burst	Search for Pattern	Pattern	Result length	Alignment	Evaluation Range
CDMA	CDMA2000_1X_FWD (F1CD, CDMA2K_1X_FWD)	QPSK CDMA2K_FWD	1.2288 MHz	CDMA 2000 1X FWD Low ISI Meas Filter	-	-	-	-	800	Capture/Left	-
	CDMA2000_1X_REV (R1CD)	Offset QPSK Gray	1.2288 MHz	CDMA 2000 1X Reverse Low ISI Meas Filter	-	-	-	-	800	Capture / Left	-
APCO25	APCO25_C QPSK	$\pi/4$ DQPSK APCO25	4.8 kHz	RC NONE	0.2	-	-	-	200	Capture/Left	-
	APCO25_C 4FM	4FSK APCO25	4.8 kHz	APCO25 C4FM Rectangular	-	-	-	-	200	Capture Left	-
Bluetooth	Blue-tooth_DH1	2FSK Natural	1 MHz	GMSK None	0.5	✓	-	-	366	Burst to Center	2 - 363.75
	Blue-tooth_DH3	2FSK Natural	1 MHz	GMSK None	0.5	✓	-	-	1622	Burst to Center	2 - 1619.75
	Blue-tooth_DH5	2FSK Natural	1 MHz	GMSK None	0.5	✓	-	-	2870	Burst to Center	2 - 2867.75
DECT	DECT_P32_FixedPart (DECT_FP)	2FSK Natural	1.152 MHz	GMSK None	0.5	✓	✓	DECT_PP DECT_PP_Pro longed	424	Capture Left	0 - 799.75
	DECT_P32_Portable-Part	2FSK Natural	1.152 MHz	GMSK None	0.5	✓	✓	DECT_FP DECT_FP_Pro longed	424	Capture Left	-

\*) The SCPI parameter for remote commands is provided where it differs from the standard name or a short form is available.

## Predefined Standards and Settings

Folder	Standard (SCPI *)	Modulation Mapping	Symbol rate	Transmit Filter Meas.Filter	Alpha/BT	Search for Burst	Search for Pattern	Pattern	Result length	Alignment	Evaluation Range
DVB-S2	DVB_S2_8_PSK	8PSK DVB_S2_8P SK	20 MHz	RRC RRC	0.35	-	-	-	90	Capture Left	-
	DVB_S2_1_6APSK	UserQAM 16ary DVB_S2_16 APSK_34	20 MHz	RRC RRC	0.35	-	-	-	180	Capture Left	-
	DVB_S2_3_2APSK	UserQAM 32ary DVB_S2_32 APSK_34	20 MHz	RRC RRC	0.35	-	-	-	270	Capture Left	-
ZIGBEE	DVB_S2_Q_PSK	QPSK DVB_S2_Q PSK	20 MHz	RRC RRC	0.35	-	-	-	90	Capture Left	-
	ZIG-BEE_BPSK_868M_300K	BPSK Natural	300 kHz	RC None	1.0	✓	-	-	1000	Burst to Center	-
	ZIG-BEE_BPSK_915M_600K	BPSK Natural	600 kHz	RC None	1.0	✓	-	-	1000	Burst to Center	-
	ZIG-BEE_QPSK_2450M_1M	Offset- QPSK Gray	1 MHz	Half Sine -	-	✓	-	-	1000	Burst to Center	-

\*) The SCPI parameter for remote commands is provided where it differs from the standard name or a short form is available.

## A.2 Predefined Measurement and Tx Filters

The most frequently required measurement and TX filters required for vector signal analysis according to digital standards are provided by the R&S FSW VSA application.

For general information on the use of these filters see [chapter 4.1, "Filters and Bandwidths During Signal Processing"](#), on page 50.

### A.2.1 Transmit Filters

The transmit filters required for common standards are predefined in the VSA application.

**Table 1-2: Overview of predefined Transmit filters**

RC	Raised cosine
RRC	Root raised cosine
Gauss	Gauss filter
GMSK	Gauss filter convolved with a rectangular filter; typically used for MSK
Linearized GMSK	Standard-specific filter for GSM EDGE (3GPP TS 45.004), normal symbol rate
EDGE Narrow Pulse Shape	Standard-specific filter for GSM EDGE (higher symbol rate)
EDGE Wide Pulse Shape	Standard-specific filter for GSM EDGE (higher symbol rate)
Half Sine	Half Sine filter
APCO25 C4FM	Filter for the APCO25 C4FM standard.
APCO25 H-CPM	Filter for the APCO25 Phase 2 standard.
APCO25 DQPSK	Filter for the APCO25 Phase 2 standard.
APCO25 DQPSK Narrow	Filter for the APCO25 Phase 2 standard.
APCO25 DQPSK Wide	Filter for the APCO25 Phase 2 standard.
CDMA2000 1X Forward	Filter for CDMA ONE forward link (TIA/EIA/IS-95-A May 1995) and CDMA2000 1X forward link ( <a href="http://www.3gpp2.org/Public_html/specs/C.S0002-C_v1.0.pdf">http://www.3gpp2.org/Public_html/specs/C.S0002-C_v1.0.pdf</a> 28/05/2002)
CDMA2000 1X Reverse	Filter for CDMA ONE forward link (TIA/EIA/IS-95-A May 1995) and CDMA2000 1X reverse link ( <a href="http://www.3gpp2.org/Public_html/specs/C.S0002-C_v1.0.pdf">http://www.3gpp2.org/Public_html/specs/C.S0002-C_v1.0.pdf</a> 28/05/2002)
Rectangular	Rectangular filter in the time domain with a length of 1 symbol period
None	No filter is used.
USER	User-defined filter. Define the filter using the <code>[SENSe:]DDEMod:TFILter:USER</code> command.

### A.2.2 Measurement Filters

The most frequently required measurement filters are predefined in the VSA application.

**Table 1-3: Overview of predefined measurement filters**

EDGE NSR	Measurement filter required for the "EDGE, Normal Symbol Rate" standard. (see 3GPP TS 45.005, chapter 4.6 Modulation Accuracy). The resulting system is NOT inter-symbol interference free.
EDGE HSR (Narrow Pulse)	Measurement filter required for the "EDGE, High Symbol Rate, Narrow Pulse" standard.
EDGE HSR (Wide Pulse)	Measurement filter required for the "EDGE, High Symbol Rate, Wide Pulse" standard.
Gauss	Classic Gauss filter with an adjustable BT
Low ISI Meas Filter	Measurement filter implemented to retain a low intersymbol interference. Best suited for eye diagrams or I/Q vector diagrams. Not necessarily suited for EVM evaluation due to amplification in the pass band.
Low Pass (Narrow)	Pass band up to $F_{\text{symbol}}/2$ Stop band starts at $F_{\text{symbol}}$ (-40dB)
Low Pass (Wide)	Pass band up to $F_{\text{symbol}}$ Stop band starts at $1.5 \cdot F_{\text{symbol}}$ (-40dB)
Rectangular	Rectangular filter in the time domain with a length of 1 symbol period; integrate and dump effect
RRC	Root Raised Cosine Filter. The roll-off parameter "Alpha" is set according to the Transmit filter if the "Auto (according to Transmit filter)" option is enabled (see "Using the Transmit Filter as a Measurement Filter (Auto)" on page 180). Otherwise it must be set manually.  If the Transmit filter is also a Root Raised Cosine filter with the same roll-off parameter, the resulting system is inter-symbol interference free.
USER	User-defined filter.  Define the filter using the <a href="#">Load User Filter</a> function or the <code>[SENSe:]DDEMod:MFILter:USER</code> command.  For details see <a href="#">chapter 7.2.1, "How to Select User-Defined Filters"</a> , on page 204.
NONE	No measurement filter is used.

The frequency response of the available standard-specific measurement filters is shown in [chapter A.5.6.2, "Measurement Filter"](#), on page 418.

### A.2.3 Typical Combinations of Tx and Measurement Filters

Typical combinations of Tx and Meas filters are shown in [table 1-4](#); they can be set in the VSA application using "Meas filter = AUTO" (see "Using the Transmit Filter as a Measurement Filter (Auto)" on page 180).

**Table 1-4: Typical combinations of Tx and Meas filters**

Transmit filter	Measurement filter (analyzer)	Remarks
RC (raised cosine)	-	filter combination without intersymbol interference (ISI)
RRC (root raised cosine)	RRC	filter combination without ISI
GMSK	-	filter combination with low ISI
Linearized GMSK	EDGE NSR	standard specific filter; filter combination with ISI
Gauss	-	filter combination with low ISI
Rectangular	-	filter combination without ISI
Half Sine	-	filter combination without ISI
CDMA2000 1X FORWARD	Low ISI Meas Filter	filter combination without ISI
CDMA2000 1X REVERSE	Low ISI Meas Filter	filter combination without ISI
APCO25 C4FM	Rectangular	filter combination without ISI
APCO25 H-CPM	Rectangular	filter combination without ISI
APCO25 H-DQPSK	Low ISI Meas Filter	filter combination without ISI
APCO25 H-D8PSK Narrow	Low ISI Meas Filter	filter combination without ISI
APCO25 H-D8PSK Wide	Low ISI Meas Filter	filter combination without ISI
EDGE Narrow Pulse Shape	EDGE HSR (Narrow Pulse)	standard specific filter; filter combination with ISI
EDGE Wide Pulse Shape	EDGE HSR (Wide Pulse)	standard specific filter; filter combination with ISI
User	Low ISI Meas Filter	filter combination with low ISI

### A.3 ASCII File Export Format for VSA Data

The data of the file header consist of three columns, each separated by a semicolon: parameter name; numeric value; basic unit. The data section starts with the keyword "Trace <n>" (<n> = number of stored trace), followed by the measured data in one or several columns (depending on the result type) which are also separated by a semicolon.

If several traces in several windows are exported to one file, the data for each window is listed subsequently. Within the data for a single window, the data for the individual traces is listed subsequently.

For details on which data is stored for which result display, see [TRACe<n> \[ : DATA \]](#) on page 363.

**Table 1-5: ASCII file format for VSA trace data export**

File contents	Description
<b>Header</b>	
Type;FSW;	Instrument model

## ASCII File Export Format for VSA Data

File contents	Description
Version;1.40;	Firmware version
Date;01.Apr 2012;	Date of data set storage
<b>Header section for individual window</b>	
Screen;1;	Window name
Points per Symbol;4;	Points per symbol
x Axis Start;-13;sym;	Start value of the x axis
x Axis Stop;135;sym;	Stop value of the x axis
y per div;0.22000000000000003;	Y axis range per division
Ref value y axis;-10.00;dBm;	Y axis reference value
Ref value position;100;%;	Y axis reference position
<b>Header section for individual trace</b>	
Trace; 1;	First trace
Meas Result;IQ;	Result type
Meas Signal;Meas;	Data source (measurement or reference data)
Demodulator;Offset QPSK;	Demodulation type
ResultMode;Trace;	Result mode
x unit;sym;	Unit of the x axis
y unit;dBm;	Unit of the y axis
Trace Mode;Clear Write;	Trace mode
Values;800;	Number of measurement points
<b>Data section for individual trace</b>	
10000;-10.3;-15.7 10130;-11.5;-16.9 10360;-12.0;-17.4 ...;...;	Measured values: <x value>, <y1>, <y2>; <y2> is only available with detector AUTOPEAK and contains the smallest of the two measured values for a measurement point
<b>Header section for individual trace</b>	
Trace; 2;	Next trace in same window
Meas Result;IQ;	Result type
Meas Signal;Meas;	Data source (measurement or reference data)
Demodulator;Offset QPSK;	Demodulation type
ResultMode;Trace;	Result mode
x unit;sym;	Unit of the x axis
y unit;dBm;	Unit of the y axis
Trace Mode;Clear Write;	Trace mode

File contents	Description
Values;800;	Number of measurement points
<b>Data section for individual trace</b>	
...	
<b>Header section for individual window</b>	
Screen;2;	Name of next window
...	
<b>Header section for individual trace</b>	
Trace; 1;	First trace in second window
<b>Data section for individual trace</b>	
...	

## A.4 Known Data File Syntax Description

When you load a Known Data file, the R&S FSW-K70 application checks whether the file complies with the following syntax:

**Table 1-6: Known Data File Syntax**

Syntax	Possible Values	Description
<RS_VSA_KNOWN_DATA_FILE Version="01.00">	as specified	File Header
<Comment></Comment>	arbitrary	Optional file description
<Base></Base>	2   16	The base used to specify the <Data> values (binary or hexadecimal) For <ModulationOrder> values $\geq 32$ , use binary (2).
<ModulationOrder></Modulation- Order>	2   4   8   16   32   64   128   256	Number of values each symbol can represent (order of modulation), e.g. 8 for 8-PSK For <ModulationOrder> values $\geq 32$ , use <Base> = 2.
<ResultLength></ResultLength>	1 ... up to 2000 <sup>*)</sup>	Number of symbols in each <Data> element The number must be identical to the "Result Length" setting in the "Result Range" dialog box, i.e. the number of symbols to be demodulated.
*) the exact number also depends on available memory space		



Syntax	Possible Values	Description
<Data></Data>	One character per symbol in the sequence Possible characters are: 0 to n-1, where n is the <ModulationOrder> Spaces, tabs and line breaks are ignored	One possible sequence of symbols that can be demodulated from the input signal Up to 6000 <sup>*)</sup> different sequences, i.e. <Data>-elements, can be defined in total
</RS_VSA_KNOWN_DATA_FILE>	as specified	File End
*) the exact number also depends on available memory space		

### Sample xml file for known data

```
<RS_VSA_KNOWN_DATA_FILE Version="01.00">

  <Comment> Standard EDGE_8PSK </Comment>
  <Base>          16 </Base>
  <ModulationOrder> 8 </ModulationOrder>
  <ResultLength> 148 </ResultLength>

  <Data> 777 511 727 242 206 341 366 632 073 607
        770 173 705 631 011 235 507 476 330 522
        177 177 171 117 777 177 717 717 111 615
        527 046 104 004 106 047 125 415 723 344
        241 264 773 111 337 446 514 600 677 7 </Data>

  <Data> 77 511 727 242 206 341 366 632 073 607
        770 173 705 631 011 235 507 476 330 522
        177 177 171 117 777 177 717 717 111 615
        527 046 104 004 106 047 125 415 723 344
        241 264 773 111 337 446 514 600 677 7 7 </Data>

  <Data> 7 511 727 242 206 341 366 632 073 607
        770 173 705 631 011 235 507 476 330 522
        177 177 171 117 777 177 717 717 111 615
        527 046 104 004 106 047 125 415 723 344
        241 264 773 111 337 446 514 600 677 7 77 </Data>

  <Data> 7 777 511 727 242 206 341 366 632 073 607
        770 173 705 631 011 235 507 476 330 522
        177 177 171 117 777 177 717 717 111 615
        527 046 104 004 106 047 125 415 723 344
        241 264 773 111 337 446 514 600 677 </Data>

  <Data> 77 777 511 727 242 206 341 366 632 073 607
        770 173 705 631 011 235 507 476 330 522
        177 177 171 117 777 177 717 717 111 615
        527 046 104 004 106 047 125 415 723 344
```

```

241 264 773 111 337 446 514 600 67          </Data>
</RS_VSA_KNOWN_DATA_FILE>

```

## A.5 Formulae

- [Trace-based Evaluations](#).....410
- [Result Summary Evaluations](#).....412
- [Statistical Evaluations for the Result Summary](#).....415
- [Trace Averaging](#).....416
- [Analytically Calculated Filters](#).....416
- [Standard-Specific Filters](#).....417

### A.5.1 Trace-based Evaluations

The trace-based evaluations all take place at the sample rate defined by the "Display Points Per Symbol" parameter (see "Display Points/Sym" on page 198). The sampling instants at this rate are referred to as "t" here, i.e.

$$t = n \cdot T_D$$

where  $T_D$  equals the duration of one sampling period at the sample rate defined by the "Display Points Per Symbol" parameter.

Test parameter	Formula
Error vector	$EV(t) = MEAS(t) - REF(t)$
Error Vector Magnitude (EVM)	$EVM(t) = \frac{ EV(t) }{C}$ <p>with the normalization constant C depends on your setting. By default C<sup>2</sup> is the mean power of the reference signal.</p> $C = \sqrt{\frac{1}{K} \sum_k  REF(k \cdot T) ^2}$ <p><math>T</math> = duration of symbol periods</p>
Magnitude	$Mag_{MEAS}(t) =  MEAS(t) $ $Mag_{REF}(t) =  REF(t) $
Phase	$Phase_{MEAS}(t) = \angle(MEAS(t))$ $Phase_{REF}(t) = \angle(REF(t))$

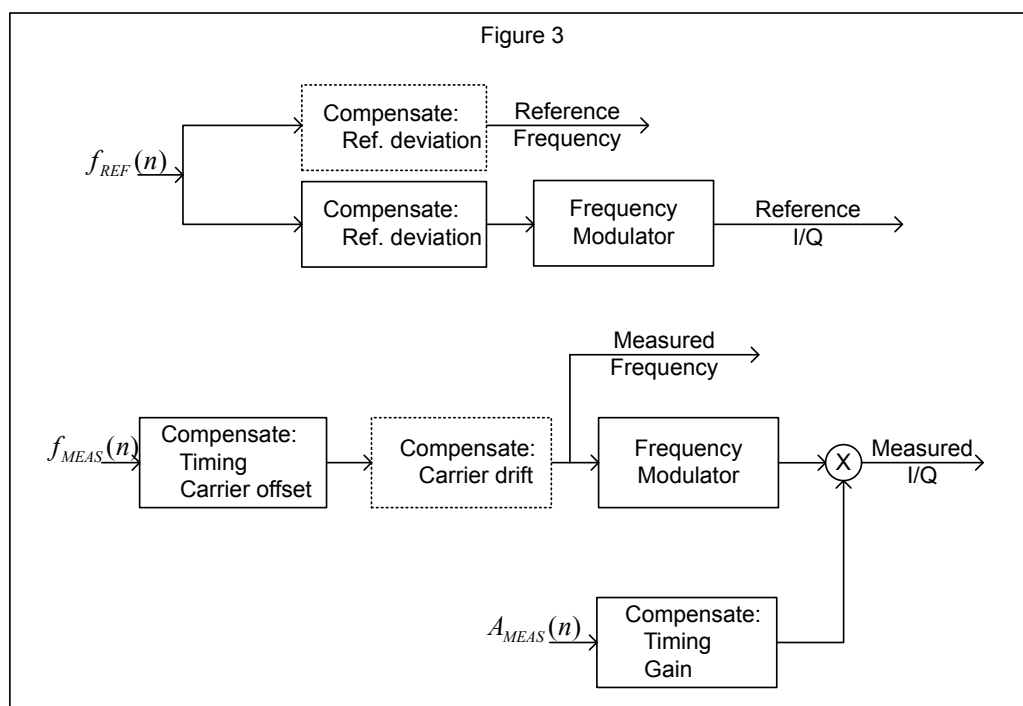
Test parameter	Formula
Frequency	$FREQ_{MEAS}(t) = \frac{1}{2 \cdot \pi} \frac{d}{dt} \angle MEAS(t)$ $FREQ_{REF}(t) = \frac{1}{2 \cdot \pi} \frac{d}{dt} \angle REF(t)$
Magnitude error	$MAG\_ERR(t) = MAG_{MEAS}(t) - MAG_{REF}(t)$
Phase error	$PHASE\_ERR(t) = PHASE_{MEAS}(t) - PHASE_{REF}(t)$
Frequency error	$FREQ\_ERR(t) = FREQ_{MEAS}(t) - FREQ_{REF}(t)$

### FSK Modulation

The trace based results for FSK signals are the same as those available for linear modulation types. However, as the signal processing for FSK signals is performed on the magnitude and instantaneous frequency, the I/Q based results first require a reconstruction of the reference and measured I/Q waveforms, as illustrated in [Reconstruction of the reference and measured I/Q waveforms for FSK modulation](#).

The dashed outline of the "compensate" blocks indicate that these operations are optionally (de-)activated depending on the corresponding user settings. With respect to FSK measurements, the optional compensation parameters are:

- [FSK Reference deviation](#)
- [Carrier frequency drift](#)



**Fig. 1-1: Reconstruction of the reference and measured I/Q waveforms for FSK modulation**

Note that a reference deviation error is corrected in the reference frequency trace. This ensures that the frequency deviation in the measured frequency trace corresponds to that of the originally measured signal. With respect to the I/Q reconstruction, the measured magnitude is timing compensated using the timing offset estimated from the measured instantaneous frequency. This ensures that the measured magnitude and frequency remain synchronized in the reconstructed I/Q waveform.

## A.5.2 Result Summary Evaluations

The evaluations for the result summary take place at the sample rate defined by the "Display Points Per Symbol" parameter (see "Display Points/Sym" on page 198). This value can be one of the following:

- "1": only the symbol instant contributes to the result
- "2": two samples per symbol instant contribute to the result (required for offset QPSK)
- the "Sample rate" defined for data acquisition (see "Sample Rate" on page 153): all samples contribute to the result equally

The results are determined by the evaluation range.

The sampling instants at this rate are referred to as "t" here, i.e.

$$t = n \cdot T_D$$

where  $T_D$  equals the duration of one sampling period at the sample rate defined by the "Display Points Per Symbol" parameter

### A.5.2.1 PSK, QAM and MSK Modulation

For PSK, QAM and MSK modulation the estimation model is described in detail in chapter [chapter 4.5.1, "PSK, QAM and MSK Modulation"](#), on page 96. The parameters of the PSK, QAM and MSK-specific result summary table can be related to the distortion model parameters as follows:

**Table 1-7: Evaluation of results in the PSK, QAM and MSK result summary**

EVM	RMS	$\sqrt{\frac{1}{N} \sum_n EVM(n \cdot T_D)^2}$
	Peak	$\max(EVM(n \cdot T_D))$
Modulation error	RMS	$-20 \cdot \log_{10} \left( \frac{\sqrt{\frac{1}{N} \sum_n  EV(n \cdot T_D) ^2}}{\sqrt{\frac{1}{K} \sum_k  REF(k \cdot T) ^2}} \right)$
	Peak	$\min(MER(n \cdot T_D))$  $\text{with } MER(n \cdot T_D) = -20 \cdot \log_{10} \left( \frac{\sqrt{\frac{1}{N} \sum_n  EV(n \cdot T_D) ^2}}{\sqrt{\frac{1}{K} \sum_k  REF(k \cdot T) ^2}} \right)$
Magnitude error	RMS	$\sqrt{\frac{1}{N} \sum_n  MAG\_ERR(n \cdot T_D) ^2}$
	Peak	$\max(MAG\_ERR(n \cdot T_D))$
Phase error	RMS	$\sqrt{\frac{1}{N} \sum_n  PHASE\_ERR(n \cdot T_D) ^2}$
	Peak	$\max(PHASE\_ERR(n \cdot T_D))$
RHO (correlation coefficient)		$\rho = \frac{\left  \sum_n REF^*(n) \cdot MEAS(n) \right ^2}{\sum_n  REF(n) ^2 \cdot \sum_n  MEAS(n) ^2} = \frac{ KKF(MEAS, REF) ^2}{AKF(REF) \cdot AKF(MEAS)}$

IQ Offset C		$C_{[lin]} = \frac{\left(\frac{c_I}{g_I}\right)^2 + \left(\frac{c_Q}{g_Q}\right)^2}{\frac{1}{K} \sum_k  REF(k \cdot T) ^2}$ $C = 10 \cdot \log_{10}(C_{[lin]}) [\text{dB}]$
IQ Imbalance B		$B_{[lin]} = \frac{ g_I - g_Q \cdot e^{j\theta} }{ g_I + g_Q \cdot e^{j\theta} }$ $B = 20 \cdot \log_{10}(B_{[lin]}) [\text{dB}]$
Gain Imbalance G		$G_{[lin]} = \frac{g_Q}{g_I}$ $G = 20 \cdot \log_{10}(G_{[lin]}) [\text{dB}]$
Quadrature Error $\Theta$		$\theta_{[lin]} = \frac{\vartheta}{\pi} \cdot 180^\circ$ $\theta = \theta_{[lin]} [\text{deg}]$
Amplitude Droop A		$A_{[lin]} = e^{-\alpha T}$ $A = 20 \cdot \log_{10}(A_{[lin]}) [\text{dB}/\text{Sym}]$

### A.5.2.2 FSK Modulation

For FSK modulation the estimation model is described in detail in section [chapter 4.5.2, "FSK Modulation"](#), on page 106. The parameters of the FSK-specific result summary table can be related to the distortion model parameters as follows:

**Table 1-8: Evaluation of results in the FSK result summary**

Frequency Error	RMS	$\sqrt{\frac{1}{N} \sum_n  FREQ\_ERR(n \cdot T_D) ^2}$
	Peak	$\max(FREQ\_ERR(n \cdot T_D))$
Magnitude Error	RMS	$\sqrt{\frac{1}{N} \sum_n  MAG\_ERR(n \cdot T_D) ^2}$
	Peak	$\max(MAG\_ERR(n \cdot T_D))$

FSK Deviation Error $\Lambda_{ERR}$		$\Lambda_{ERR} = \Lambda_{MEAS} - \Lambda_{REF} = (B - 1) \cdot \Lambda_{REF}$ Estimated FSK deviation error [Hz].
FSK Measurement Deviation $\Lambda_{MEAS}$		$\Lambda_{MEAS} = B \cdot \Lambda_{REF}$ Estimated FSK deviation of the meas signal [Hz].
FSK Reference Deviation $\Lambda_{REF}$		FSK reference deviation as entered by the user [Hz].
Carrier Frequency Error $f_0$		$f_0 = \frac{C}{2 \cdot \pi}$ The carrier frequency error of the measured signal [Hz].
Carrier Frequency Drift $f_d$		$f_d = \frac{D}{2 \cdot \pi \cdot T}$ The drift in the carrier frequency of the measured signal [Hz/Sym].

### A.5.3 Statistical Evaluations for the Result Summary

The statistical evaluations in the result summary are based on the measurement results that are displayed in the "Current" column. Hence, the index "m" here represents the current evaluation, "M" is the total number of evaluations. In single sweep mode, M corresponds to the statistics count.

If the measurement values are represented in the logarithmic domain, the linear values are averaged. The result is then subsequently converted back into logarithmic domain. The linear values are indicated by the subscript [lin] in [chapter A.5.2.1, "PSK, QAM and MSK Modulation"](#), on page 413.

	Mathematical expression	Calculation in R&S FSW
Mean $\hat{x}_M$	$\bar{x}_M = \frac{1}{M} \sum_m x_m$	$\bar{x}_M = \frac{(M-1) \cdot \bar{x}_{M-1} + x_M}{M}$ with $\bar{x}_0 = 0$
Peak $\hat{x}_M$	$\hat{x}_M = x_{idx}$ with $idx = \arg \max_m  x_m $	$\hat{x}_M = x_M$ if $ x_M  >  \hat{x}_{M-1} $ $\hat{x}_M = x_{M-1}$ if $ x_M  \leq  \hat{x}_{M-1} $ with $\bar{x}_0 = 0$

	Mathematical expression	Calculation in R&S FSW
StdDev $\sigma_M$	$\sigma_M = \sqrt{\frac{1}{M} \sum_m (x_m - \bar{x}_M)^2}$ <p>with</p> $\bar{x}_M = \frac{1}{M} \sum_m x_m$	$\sigma_M = \sqrt{\frac{(M-1) \cdot \sigma_{M-1}^2 + (x_M - \bar{x}_M)^2}{M}}$ <p>with</p> $\sigma_0 = 0$
95%ile $x_{95,M}$	$x_{95,M} = \{x   \Pr(x_m \leq x) = 0.95\}$ <p>Pr() denotes the probability</p>	Sorting the values and giving the 95%ile.

#### A.5.4 Trace Averaging

The index "m" represents the current evaluation, "M" is the total number of evaluations. In single sweep mode, M corresponds to the statistics count. The index "s" represents the s<sup>th</sup> sample within the trace.

If the measurement results are represented in logarithmic domain, the average operation is performed on the linear values. The result is then subsequently converted back into logarithmic domain.

	Measurements	Calculation in R&S FSW
RMS Average $\bar{x}_{s,M}$	<ul style="list-style-type: none"> <li>• Error Vector Magnitude (EVM)</li> <li>• Meas/Ref magnitude</li> <li>• Capture Buffer magnitude</li> </ul>	$\bar{x}_{s,M} = \sqrt{\frac{(M-1) \cdot \bar{x}_{s,M-1}^2 + x_{s,M}^2}{M}}$
Linear Average $\bar{x}_{s,M}$	All measurements where trace averaging is possible <b>except for</b> the measurements listed for RMS averaging	$\bar{x}_{s,M} = \frac{(M-1) \cdot \bar{x}_{s,M-1} + x_{s,M}}{M}$

#### A.5.5 Analytically Calculated Filters

The following filters are calculated during runtime of the unit and as a function of the operating parameter Alpha or BT.



Filter Type	Setting Parameter	Impulse Response
Raised cosine (RC)	Alpha ( $\alpha$ )	$h(t) = \frac{\sin\left(\frac{\pi t}{T}\right) \cos\left(\frac{\pi \alpha t}{T}\right)}{\left(\frac{\pi t}{T}\right) \left[1 - 4\left(\frac{\alpha t}{T}\right)^2\right]}$
Root raised cosine (RRC)	Alpha ( $\alpha$ )	$h(t) = 4\alpha \frac{\cos\left((1+\alpha)\pi t/T\right) + \frac{\sin\left((1-\alpha)\pi t/T\right)}{4\alpha t/T}}{\pi \sqrt{T} \left[1 - (4\alpha t/T)^2\right]}$
Gaussian filter (Gauss) ETSI TS 100 959 (V8.3.0)	BT	$h(t) = \frac{\exp\left(\frac{-t^2}{2\rho^2 T^2}\right)}{\sqrt{(2\pi) \cdot \rho T}}$ <p>with</p> $\rho = \frac{\sqrt{\ln 2}}{2\pi BT}$

## A.5.6 Standard-Specific Filters

### A.5.6.1 Transmit filter

#### EDGE Tx filter ETSI TS 300 959 (V8.1.2) (Linearized GMSK)

$$c_0(t) = \begin{cases} \prod_{i=0}^3 S(t+iT) & \text{for } 0 \leq t \leq 5T \\ 0 & \text{else} \end{cases}$$

$$S(t) = \begin{cases} \sin\left(\pi \int_0^t g(t') dt'\right) & \text{for } 0 \leq t \leq 4T \\ \sin\left(\frac{\pi}{2} - \pi \int_0^{t-4T} g(t') dt'\right) & \text{for } 4T < t \leq 8T \\ 0 & \text{else} \end{cases}$$

$$g(t) = \frac{1}{2T} \left( Q\left(2\pi \cdot 0.3 \frac{t-5T/2}{T\sqrt{\ln(2)}}\right) - Q\left(2\pi \cdot 0.3 \frac{t-3T/2}{T\sqrt{\ln(2)}}\right) \right)$$

$$Q(t) = \frac{1}{\sqrt{2\pi}} \int_t^{\infty} e^{-\frac{\tau^2}{2}} d\tau$$

$c_0(t)$  is the impulse response of the EDGE transmit filter

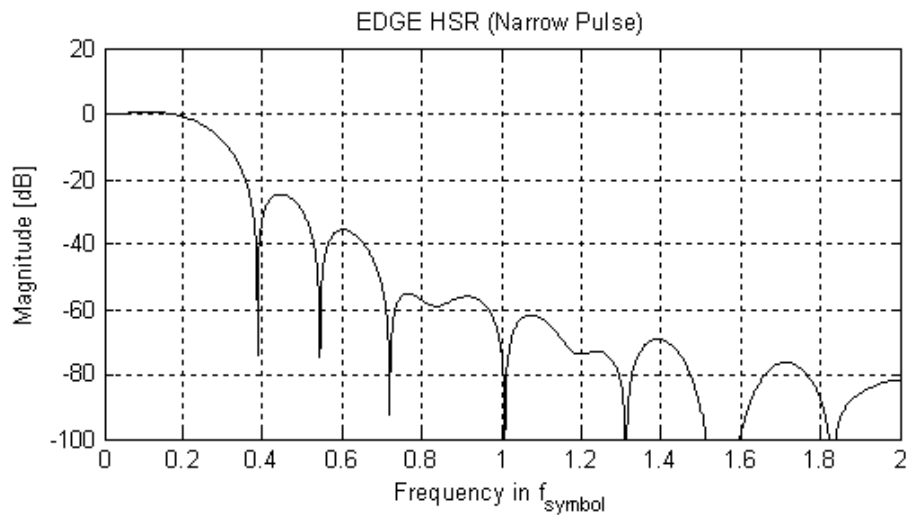
### A.5.6.2 Measurement Filter

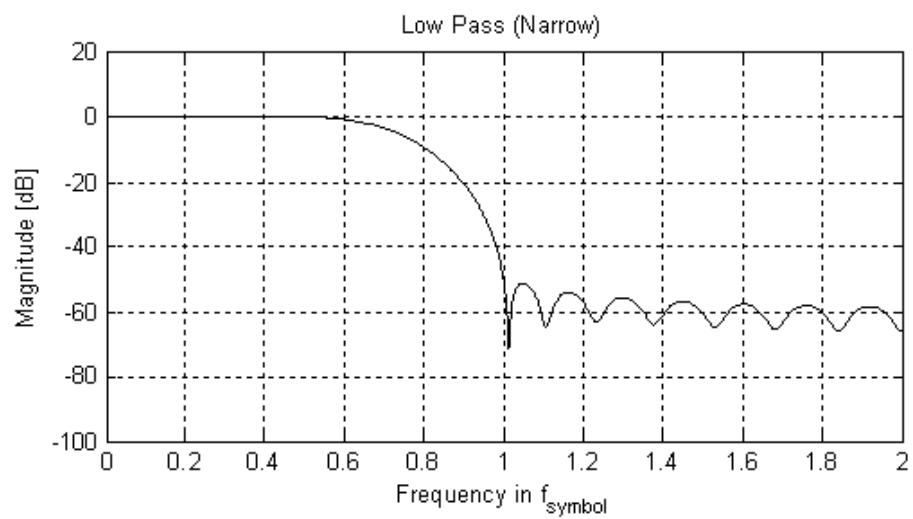
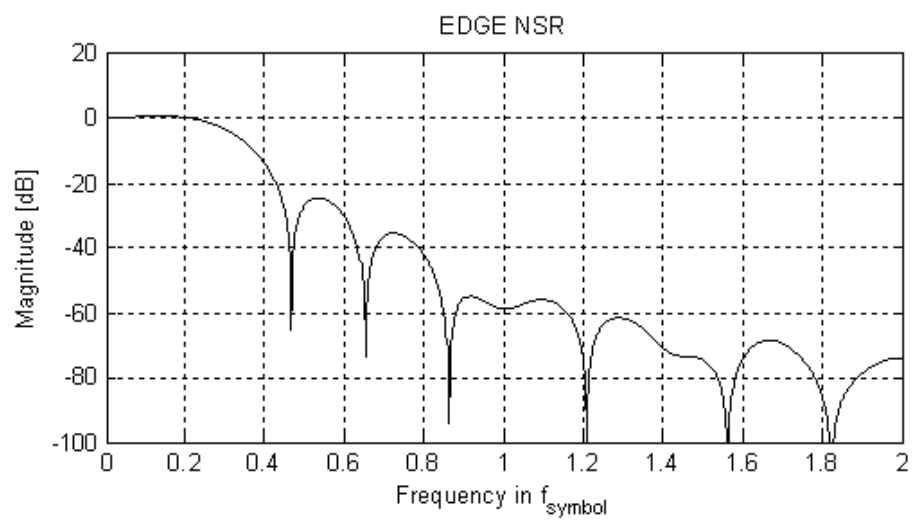
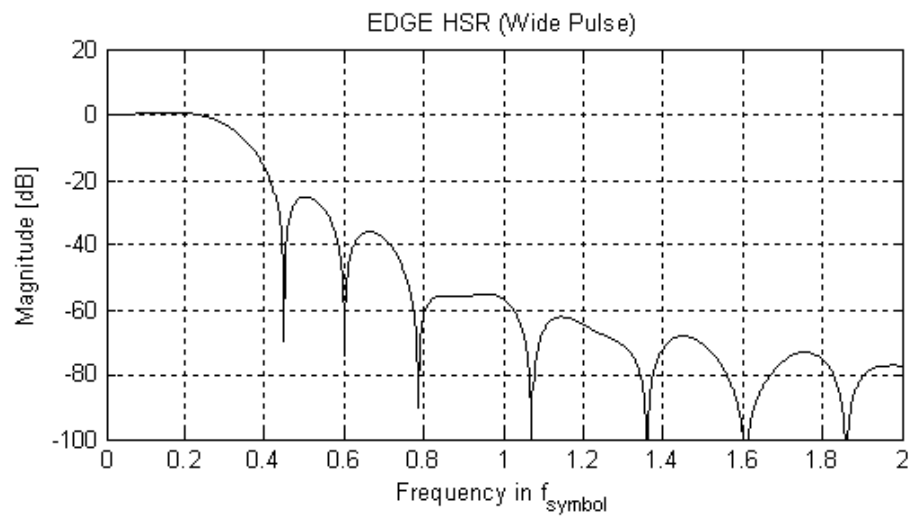
#### EDGE Measurement filters

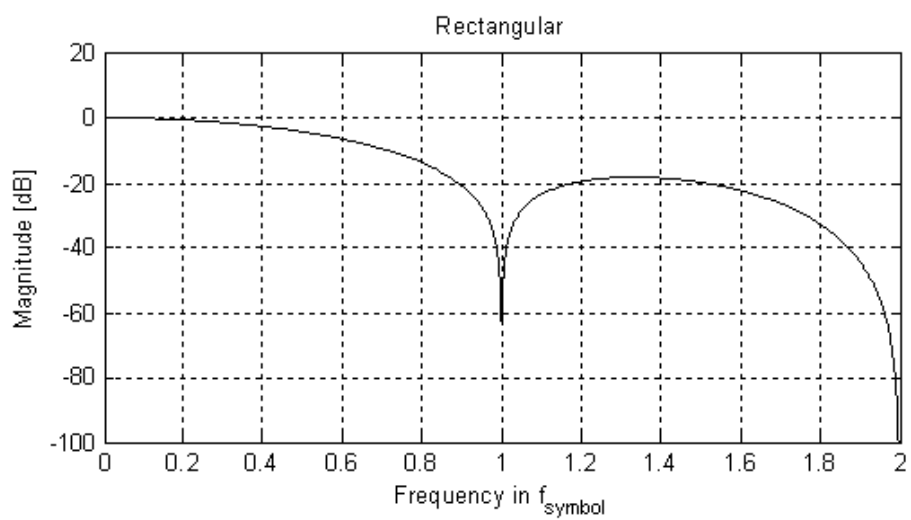
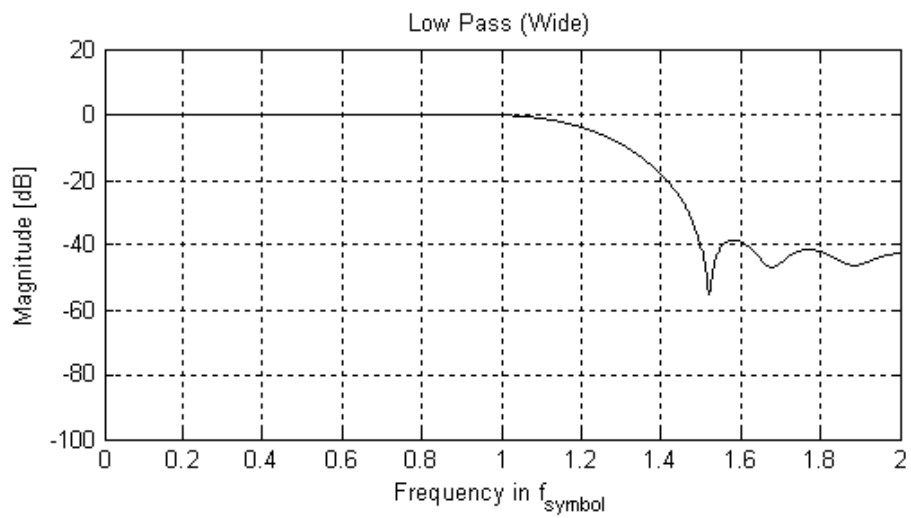
RC filter, Alpha = 0.25, single-side-band 6 dB bandwidth = 90 kHz Windowing by multiplying the impulse response according to the following equation:

$$w(t) = \begin{cases} 1, & 0 \leq |t| \leq 1.5T \\ 0.5 \left( 1 + \cos \left[ \pi \left( |t| - 1.5T \right) / 2.25T \right] \right), & 1.5T < |t| < 3.75T \\ 0, & |t| \geq 3.75T \end{cases}$$

The following figure shows the frequency response of the standard-specific measurement filters.

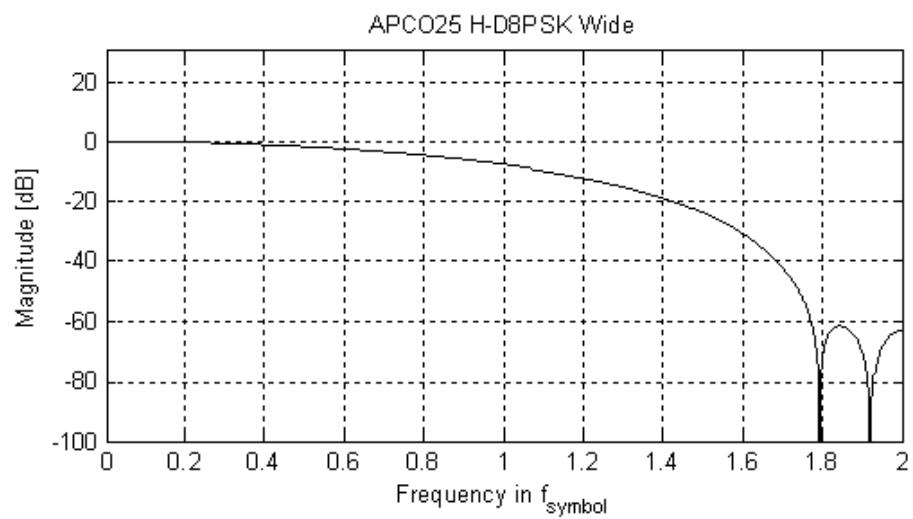
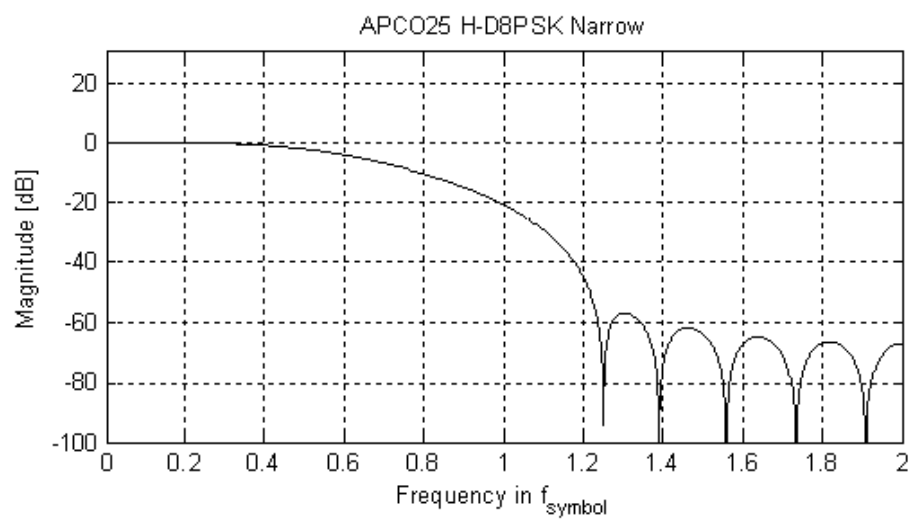
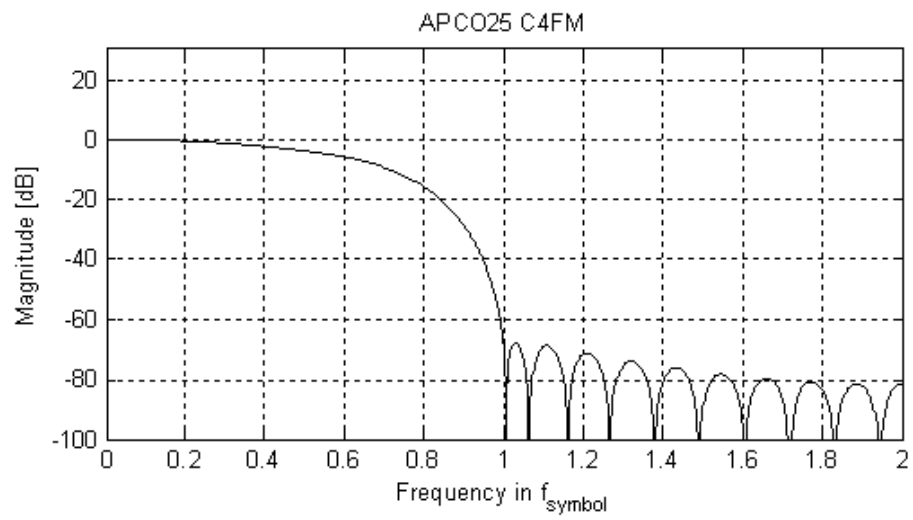


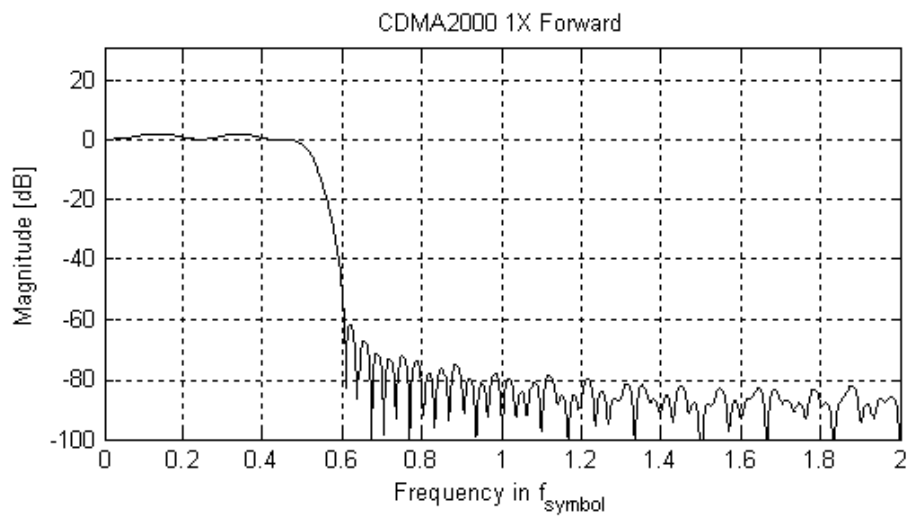
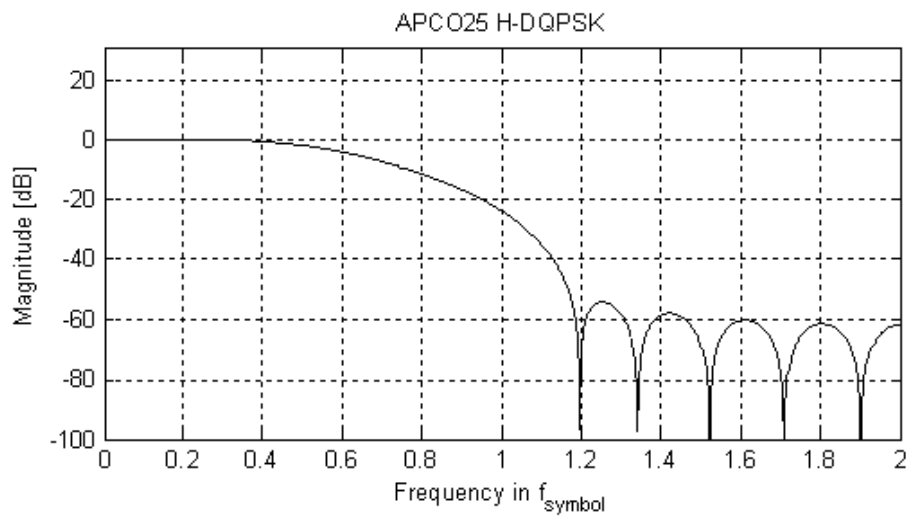
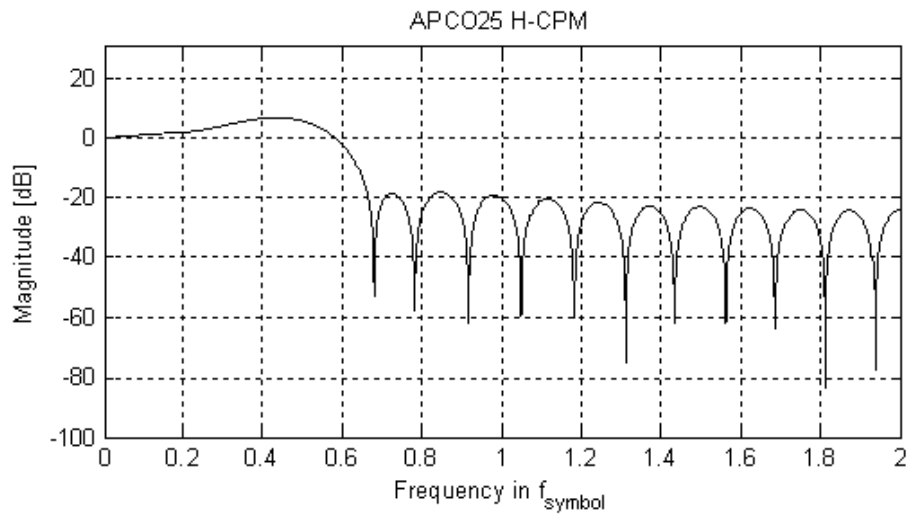


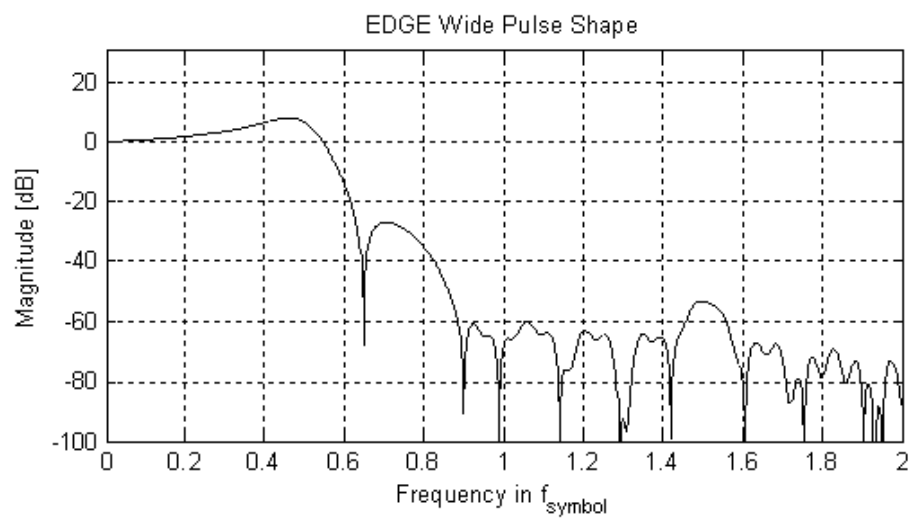
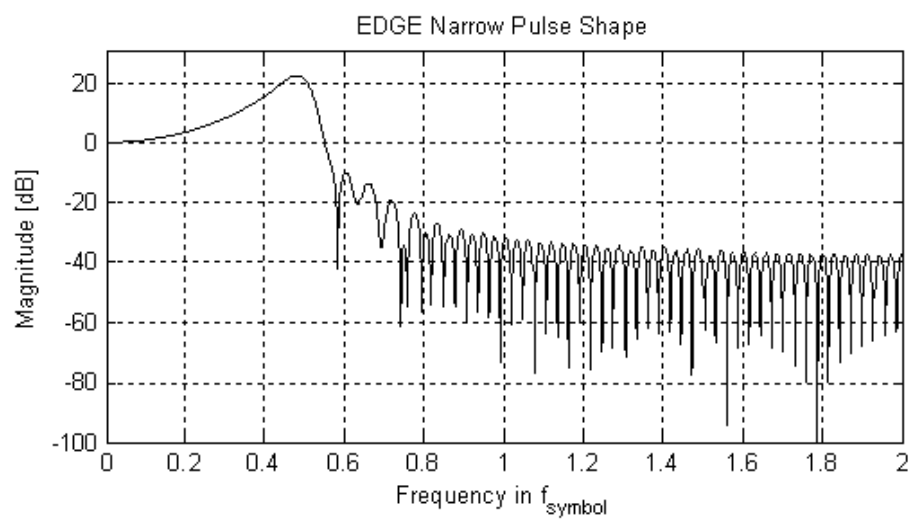
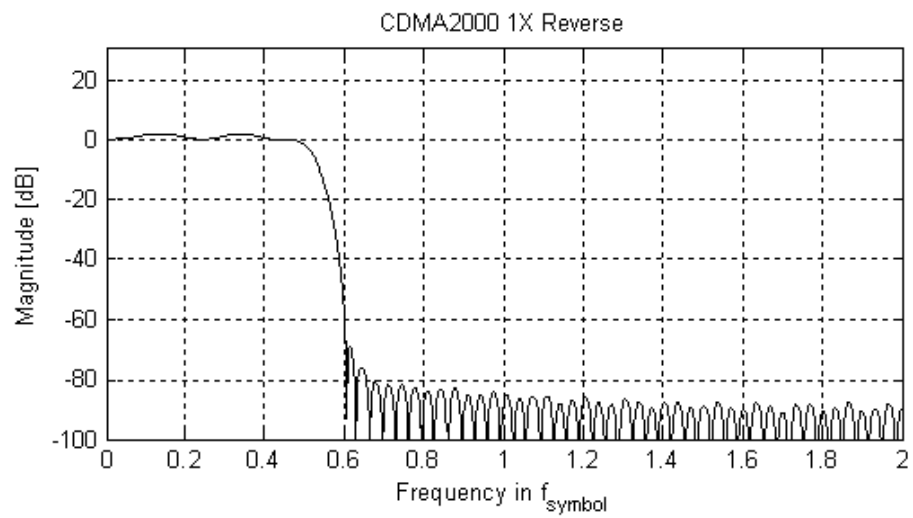


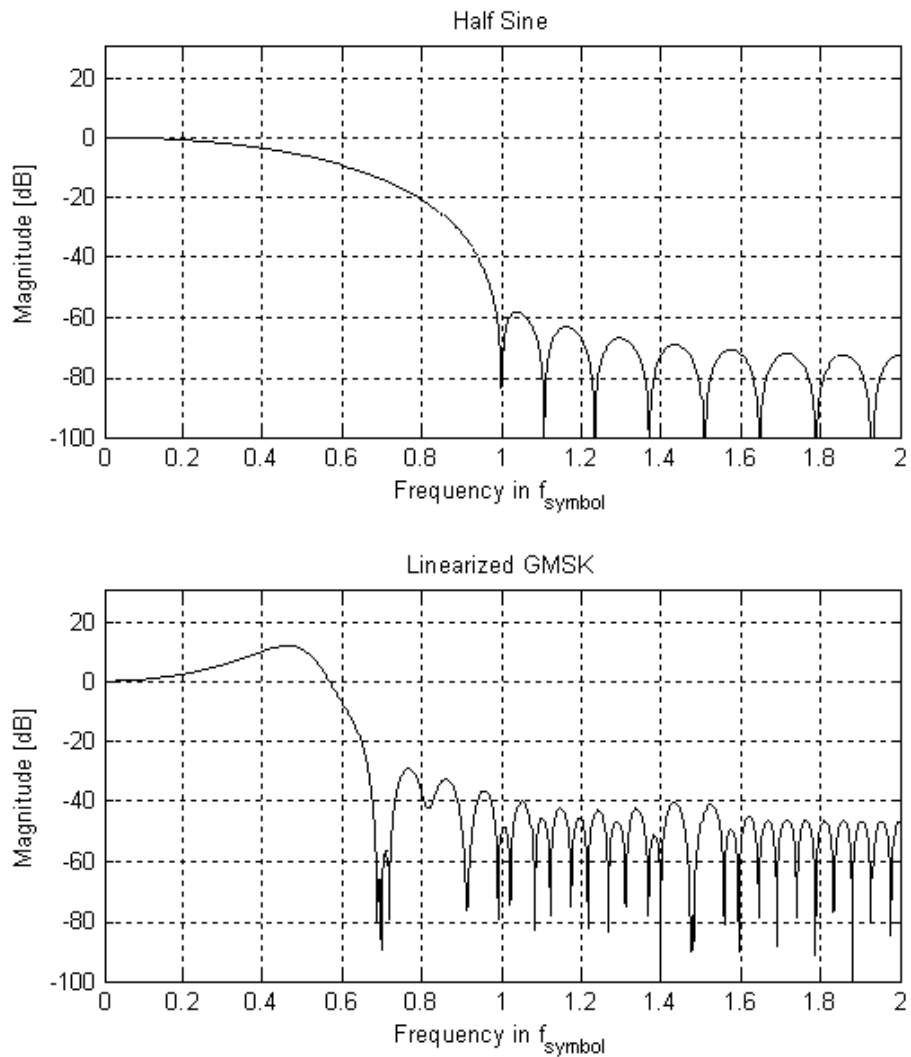
### Low-ISI Filters

The following frequency responses are obtained when using a low-ISI measurement filter and the Transmit filter indicated in the title of each diagram.









## A.6 Abbreviations

The following abbreviations are commonly used in the description of the R&S FSW-K70 option.

Abbreviation	Meaning	See section
FSK	Frequency Shift Keying Modulation mode for which the information is encrypted in the frequency.	Frequency Shift Keying (FSK)
ISI	Inter-symbol Interference	



Abbreviation	Meaning	See section
ISI-free demodulation	Demodulation structure in which the signal is no longer influenced by adjacent symbols at the decision instants after signal-adapted filtering.	System-Theoretical Modulation and Demodulation Filters
MEAS filter	Measurement Filter Weighting filter for the measurement.	System-Theoretical Modulation and Demodulation Filters
MSK	Minimum Shift Keying Modulation mode.	Minimum Shift Keying (MSK)
NDA Demodulator	Non Data Aided Demodulator Demodulation without any knowledge of the sent data contents.	Demodulation and Algorithms
PSK	Phase Shift Keying Modulation mode for which the information lies within the phase or within the phase transitions.	Phase Shift Keying (PSK)
QAM	Quadrature Amplitude Modulation Modulation mode for which the information is encrypted both in the amplitude and phase.	Quadrature Amplitude Modulation (QAM)
RMS	Root Mean Square	Averaging RMS Quantities
RX filter	Receive Filter Baseband filter in analyzer used for signal-adapted filtering.	System-Theoretical Modulation and Demodulation Filters
Transmit filter	Transmitter Filter Digital impulse shaping filter in signal processing unit of transmitter.	System-Theoretical Modulation and Demodulation Filters
VSA	Vector Signal Analysis Measurement at complex modulated RF carriers.	

## List of Remote Commands (VSA)

ABORT.....	326
CALCulate:LIMit:MACCuracy:DEFault.....	342
CALCulate:LIMit:MACCuracy:STATe.....	342
CALCulate:MARKer:X:SLIMits:LEFT.....	341
CALCulate:MARKer:X:SLIMits:RIGHT.....	341
CALCulate:MARKer:X:SLIMits[:STATe].....	342
CALCulate:MSRA:WINDow<n>:IVAL?.....	295
CALCulate<n>:BERate.....	365
CALCulate<n>:DDEM:SPECTrum[:STATe].....	357
CALCulate<n>:DELTamarker:AOFF.....	335
CALCulate<n>:DELTamarker<m>:MAXimum:APEak.....	337
CALCulate<n>:DELTamarker<m>:MAXimum:LEFT.....	337
CALCulate<n>:DELTamarker<m>:MAXimum:NEXT.....	338
CALCulate<n>:DELTamarker<m>:MAXimum:RIGHT.....	338
CALCulate<n>:DELTamarker<m>:MAXimum[:PEAK].....	338
CALCulate<n>:DELTamarker<m>:MINimum:LEFT.....	338
CALCulate<n>:DELTamarker<m>:MINimum:NEXT.....	338
CALCulate<n>:DELTamarker<m>:MINimum:RIGHT.....	339
CALCulate<n>:DELTamarker<m>:MINimum[:PEAK].....	339
CALCulate<n>:DELTamarker<m>:TRACe.....	336
CALCulate<n>:DELTamarker<m>:X.....	336
CALCulate<n>:DELTamarker<m>:X:ABSolute?.....	361
CALCulate<n>:DELTamarker<m>:X:RELative?.....	361
CALCulate<n>:DELTamarker<m>:Y?.....	336
CALCulate<n>:DELTamarker<m>[:STATe].....	336
CALCulate<n>:ELIN<startstop>:STATe.....	322
CALCulate<n>:ELIN<startstop>[:VALue].....	323
CALCulate<n>:FEED.....	389
CALCulate<n>:FORMat.....	357
CALCulate<n>:FSK:DEViation:COMPensation.....	389
CALCulate<n>:FSK:DEViation:REFerence:RELative.....	268
CALCulate<n>:FSK:DEViation:REFerence[:VALue].....	268
CALCulate<n>:LIMit:MACCuracy:<ResultType>:<LimitType>:STATe.....	343
CALCulate<n>:LIMit:MACCuracy:<ResultType>:<LimitType>[:RESUlt].....	376
CALCulate<n>:LIMit:MACCuracy:CFERror:CURRent:STATe.....	343
CALCulate<n>:LIMit:MACCuracy:CFERror:CURRent:VALue.....	344
CALCulate<n>:LIMit:MACCuracy:CFERror:CURRent[:RESUlt]?.....	375
CALCulate<n>:LIMit:MACCuracy:CFERror:MEAN:STATe.....	343
CALCulate<n>:LIMit:MACCuracy:CFERror:MEAN:VALue.....	344
CALCulate<n>:LIMit:MACCuracy:CFERror:MEAN[:RESUlt]?.....	375
CALCulate<n>:LIMit:MACCuracy:CFERror:PEAK:STATe.....	343
CALCulate<n>:LIMit:MACCuracy:CFERror:PEAK:VALue.....	344
CALCulate<n>:LIMit:MACCuracy:CFERror:PEAK[:RESUlt]?.....	375
CALCulate<n>:LIMit:MACCuracy:EVM:PCURrent:STATe.....	343
CALCulate<n>:LIMit:MACCuracy:EVM:PCURrent:VALue.....	345

CALCulate<n>:LIMit:MACCuracy:EVM:PCURrent[:RESult]?	375
CALCulate<n>:LIMit:MACCuracy:EVM:PMEan:STATe	343
CALCulate<n>:LIMit:MACCuracy:EVM:PMEan:VALue	345
CALCulate<n>:LIMit:MACCuracy:EVM:PMEan[:RESult]?	375
CALCulate<n>:LIMit:MACCuracy:EVM:PPEak:STATe	343
CALCulate<n>:LIMit:MACCuracy:EVM:PPEak:VALue	345
CALCulate<n>:LIMit:MACCuracy:EVM:PPEak[:RESult]?	375
CALCulate<n>:LIMit:MACCuracy:EVM:RCURrent:STATe	343
CALCulate<n>:LIMit:MACCuracy:EVM:RCURrent:VALue	345
CALCulate<n>:LIMit:MACCuracy:EVM:RCURrent[:RESult]?	375
CALCulate<n>:LIMit:MACCuracy:EVM:RMEan:STATe	343
CALCulate<n>:LIMit:MACCuracy:EVM:RMEan:VALue	345
CALCulate<n>:LIMit:MACCuracy:EVM:RMEan[:RESult]?	375
CALCulate<n>:LIMit:MACCuracy:EVM:RPEak:STATe	343
CALCulate<n>:LIMit:MACCuracy:EVM:RPEak:VALue	345
CALCulate<n>:LIMit:MACCuracy:EVM:RPEak[:RESult]?	375
CALCulate<n>:LIMit:MACCuracy:FDERror:CURRent:STATe	343
CALCulate<n>:LIMit:MACCuracy:FDERror:CURRent:VALue	345
CALCulate<n>:LIMit:MACCuracy:FDERror:CURRent[:RESult]?	375
CALCulate<n>:LIMit:MACCuracy:FDERror:MEAN:STATe	343
CALCulate<n>:LIMit:MACCuracy:FDERror:MEAN:VALue	345
CALCulate<n>:LIMit:MACCuracy:FDERror:MEAN[:RESult]?	375
CALCulate<n>:LIMit:MACCuracy:FDERror:PEAK:STATe	343
CALCulate<n>:LIMit:MACCuracy:FDERror:PEAK:VALue	345
CALCulate<n>:LIMit:MACCuracy:FDERror:PEAK[:RESult]?	375
CALCulate<n>:LIMit:MACCuracy:FERRor:PCURrent:STATe	343
CALCulate<n>:LIMit:MACCuracy:FERRor:PCURrent:VALue	345
CALCulate<n>:LIMit:MACCuracy:FERRor:PCURrent[:RESult]?	375
CALCulate<n>:LIMit:MACCuracy:FERRor:PMEan:STATe	343
CALCulate<n>:LIMit:MACCuracy:FERRor:PMEan:VALue	345
CALCulate<n>:LIMit:MACCuracy:FERRor:PMEan[:RESult]?	375
CALCulate<n>:LIMit:MACCuracy:FERRor:PPEak:STATe	343
CALCulate<n>:LIMit:MACCuracy:FERRor:PPEak:VALue	345
CALCulate<n>:LIMit:MACCuracy:FERRor:PPEak[:RESult]?	375
CALCulate<n>:LIMit:MACCuracy:FERRor:RCURrent:STATe	343
CALCulate<n>:LIMit:MACCuracy:FERRor:RCURrent:VALue	345
CALCulate<n>:LIMit:MACCuracy:FERRor:RCURrent[:RESult]?	375
CALCulate<n>:LIMit:MACCuracy:FERRor:RMEan:STATe	343
CALCulate<n>:LIMit:MACCuracy:FERRor:RMEan:VALue	345
CALCulate<n>:LIMit:MACCuracy:FERRor:RMEan[:RESult]?	375
CALCulate<n>:LIMit:MACCuracy:FERRor:RPEak:STATe	343
CALCulate<n>:LIMit:MACCuracy:FERRor:RPEak:VALue	345
CALCulate<n>:LIMit:MACCuracy:FERRor:RPEak[:RESult]?	375
CALCulate<n>:LIMit:MACCuracy:MERRor:PCURrent:STATe	343
CALCulate<n>:LIMit:MACCuracy:MERRor:PCURrent:VALue	346
CALCulate<n>:LIMit:MACCuracy:MERRor:PCURrent[:RESult]?	375
CALCulate<n>:LIMit:MACCuracy:MERRor:PMEan:STATe	343
CALCulate<n>:LIMit:MACCuracy:MERRor:PMEan:VALue	346

CALCulate<n>:LIMit:MACCuracy:MERRor:PMEan[:RESult]?	376
CALCulate<n>:LIMit:MACCuracy:MERRor:PPEak:STATe	343
CALCulate<n>:LIMit:MACCuracy:MERRor:PPEak:VALue	346
CALCulate<n>:LIMit:MACCuracy:MERRor:PPEak[:RESult]?	376
CALCulate<n>:LIMit:MACCuracy:MERRor:RCURrent:STATe	343
CALCulate<n>:LIMit:MACCuracy:MERRor:RCURrent:VALue	346
CALCulate<n>:LIMit:MACCuracy:MERRor:RCURrent[:RESult]?	376
CALCulate<n>:LIMit:MACCuracy:MERRor:RMEan:STATe	343
CALCulate<n>:LIMit:MACCuracy:MERRor:RMEan:VALue	346
CALCulate<n>:LIMit:MACCuracy:MERRor:RMEan[:RESult]?	376
CALCulate<n>:LIMit:MACCuracy:MERRor:RPEak:STATe	343
CALCulate<n>:LIMit:MACCuracy:MERRor:RPEak:VALue	346
CALCulate<n>:LIMit:MACCuracy:MERRor:RPEak[:RESult]?	376
CALCulate<n>:LIMit:MACCuracy:OOFfset:CURRent:STATe	343
CALCulate<n>:LIMit:MACCuracy:OOFfset:CURRent:VALue	346
CALCulate<n>:LIMit:MACCuracy:OOFfset:CURRent[:RESult]?	376
CALCulate<n>:LIMit:MACCuracy:OOFfset:MEAN:STATe	343
CALCulate<n>:LIMit:MACCuracy:OOFfset:MEAN:VALue	346
CALCulate<n>:LIMit:MACCuracy:OOFfset:MEAN[:RESult]?	376
CALCulate<n>:LIMit:MACCuracy:OOFfset:PEAK:STATe	343
CALCulate<n>:LIMit:MACCuracy:OOFfset:PEAK:VALue	346
CALCulate<n>:LIMit:MACCuracy:OOFfset:PEAK[:RESult]?	376
CALCulate<n>:LIMit:MACCuracy:PERRor:PCURrent:STATe	343
CALCulate<n>:LIMit:MACCuracy:PERRor:PCURrent:VALue	346
CALCulate<n>:LIMit:MACCuracy:PERRor:PCURrent[:RESult]?	376
CALCulate<n>:LIMit:MACCuracy:PERRor:PMEan:STATe	343
CALCulate<n>:LIMit:MACCuracy:PERRor:PMEan:VALue	346
CALCulate<n>:LIMit:MACCuracy:PERRor:PMEan[:RESult]?	376
CALCulate<n>:LIMit:MACCuracy:PERRor:PPEak:STATe	343
CALCulate<n>:LIMit:MACCuracy:PERRor:PPEak:VALue	346
CALCulate<n>:LIMit:MACCuracy:PERRor:PPEak[:RESult]?	376
CALCulate<n>:LIMit:MACCuracy:PERRor:RCURrent:STATe	343
CALCulate<n>:LIMit:MACCuracy:PERRor:RCURrent:VALue	346
CALCulate<n>:LIMit:MACCuracy:PERRor:RCURrent[:RESult]?	376
CALCulate<n>:LIMit:MACCuracy:PERRor:RMEan:STATe	343
CALCulate<n>:LIMit:MACCuracy:PERRor:RMEan:VALue	346
CALCulate<n>:LIMit:MACCuracy:PERRor:RMEan[:RESult]?	376
CALCulate<n>:LIMit:MACCuracy:PERRor:RPEak:STATe	343
CALCulate<n>:LIMit:MACCuracy:PERRor:RPEak:VALue	346
CALCulate<n>:LIMit:MACCuracy:PERRor:RPEak[:RESult]?	376
CALCulate<n>:LIMit:MACCuracy:RHO:CURRent:STATe	343
CALCulate<n>:LIMit:MACCuracy:RHO:CURRent:VALue	347
CALCulate<n>:LIMit:MACCuracy:RHO:CURRent[:RESult]?	376
CALCulate<n>:LIMit:MACCuracy:RHO:MEAN:STATe	343
CALCulate<n>:LIMit:MACCuracy:RHO:MEAN:VALue	347
CALCulate<n>:LIMit:MACCuracy:RHO:MEAN[:RESult]?	376
CALCulate<n>:LIMit:MACCuracy:RHO:PEAK:STATe	343
CALCulate<n>:LIMit:MACCuracy:RHO:PEAK:VALue	347

CALCulate<n>:LIMit:MACCuracy:RHO:PEAK[:RESult]?	376
CALCulate<n>:MARKer:SEARch	341
CALCulate<n>:MARKer<m>:AOFF	334
CALCulate<n>:MARKer<m>:FUNction:DDEMod:STATistic:ADRoop?	366
CALCulate<n>:MARKer<m>:FUNction:DDEMod:STATistic:ALL?	366
CALCulate<n>:MARKer<m>:FUNction:DDEMod:STATistic:CFERror?	366
CALCulate<n>:MARKer<m>:FUNction:DDEMod:STATistic:EVM?	367
CALCulate<n>:MARKer<m>:FUNction:DDEMod:STATistic:FDERror?	368
CALCulate<n>:MARKer<m>:FUNction:DDEMod:STATistic:FSK:CFDRift?	368
CALCulate<n>:MARKer<m>:FUNction:DDEMod:STATistic:FSK:DERRor?	368
CALCulate<n>:MARKer<m>:FUNction:DDEMod:STATistic:FSK:MDEVIation?	369
CALCulate<n>:MARKer<m>:FUNction:DDEMod:STATistic:FSK:RDEVIation?	370
CALCulate<n>:MARKer<m>:FUNction:DDEMod:STATistic:GIMBalance?	370
CALCulate<n>:MARKer<m>:FUNction:DDEMod:STATistic:IQIMbalance?	370
CALCulate<n>:MARKer<m>:FUNction:DDEMod:STATistic:MERRor?	371
CALCulate<n>:MARKer<m>:FUNction:DDEMod:STATistic:MPOWER?	371
CALCulate<n>:MARKer<m>:FUNction:DDEMod:STATistic:OOFFset?	372
CALCulate<n>:MARKer<m>:FUNction:DDEMod:STATistic:PERRor?	372
CALCulate<n>:MARKer<m>:FUNction:DDEMod:STATistic:QERRor?	373
CALCulate<n>:MARKer<m>:FUNction:DDEMod:STATistic:RHO?	374
CALCulate<n>:MARKer<m>:FUNction:DDEMod:STATistic:SNR?	374
CALCulate<n>:MARKer<m>:FUNction:DDEMod:STATistic:SRERRor?	375
CALCulate<n>:MARKer<m>:LINK	334
CALCulate<n>:MARKer<m>:MAXimum:APEak	339
CALCulate<n>:MARKer<m>:MAXimum:LEFT	339
CALCulate<n>:MARKer<m>:MAXimum:NEXT	339
CALCulate<n>:MARKer<m>:MAXimum:RIGHT	339
CALCulate<n>:MARKer<m>:MAXimum[:PEAK]	340
CALCulate<n>:MARKer<m>:MINimum:LEFT	340
CALCulate<n>:MARKer<m>:MINimum:NEXT	340
CALCulate<n>:MARKer<m>:MINimum:RIGHT	340
CALCulate<n>:MARKer<m>:MINimum[:PEAK]	340
CALCulate<n>:MARKer<m>:TRACe	335
CALCulate<n>:MARKer<m>:X	335
CALCulate<n>:MARKer<m>:Y?	361
CALCulate<n>:MARKer<m>[:STATe]	335
CALCulate<n>:STATistics:CCDF[:STATe]	358
CALCulate<n>:STATistics:MODE	359
CALCulate<n>:STATistics:PRESet	291
CALCulate<n>:STATistics:SCALE:AUTO ONCE	291
CALCulate<n>:STATistics:SCALE:X:BCOunt	291
CALCulate<n>:STATistics:SCALE:Y:LOWer	292
CALCulate<n>:STATistics:SCALE:Y:UNIT	292
CALCulate<n>:STATistics:SCALE:Y:UPPer	292
CALCulate<n>:TRACe<t>:ADJust:ALIGNment:OFFSet	311
CALCulate<n>:TRACe<t>:ADJust:ALIGNment[:DEFault]	310
CALCulate<n>:TRACe<t>:ADJust[:VALue]	311
CALCulate<n>:TRACe<t>[:VALue]	332

CALCulate<n>:UNIT:ANGLE.....	292
CALCulate<n>:X:UNIT:TIME.....	292
DISPlay:FORMat.....	349
DISPlay[:WINDow<n>]:PRATe:AUTO.....	359
DISPlay[:WINDow<n>]:PRATe[:VALue].....	359
DISPlay[:WINDow<n>]:SElect.....	350
DISPlay[:WINDow<n>]:SIZE.....	350
DISPlay[:WINDow<n>]:TRACe:SYMBol.....	360
DISPlay[:WINDow<n>]:TRACe:Y:SPACing.....	294
DISPlay[:WINDow<n>]:TRACe:Y[:SCALe].....	293
DISPlay[:WINDow<n>]:TRACe:Y[:SCALe]:AUTO ONCE.....	324
DISPlay[:WINDow<n>]:TRACe:Y[:SCALe]:MODE.....	360
DISPlay[:WINDow<n>]:TRACe:Y[:SCALe]:PDIVision.....	294
DISPlay[:WINDow<n>]:TRACe:Y[:SCALe]:RLEVel.....	286
DISPlay[:WINDow<n>]:TRACe:Y[:SCALe]:RLEVel:OFFSet.....	287
DISPlay[:WINDow<n>]:TRACe:Y[:SCALe]:RPOSition.....	294
DISPlay[:WINDow<n>]:TRACe:Y[:SCALe]:RVALue.....	294
DISPlay[:WINDow<n>]:TRACe<t>:MODE.....	333
DISPlay[:WINDow<n>]:TRACe<t>:X[:SCALe]:PDIVision.....	293
DISPlay[:WINDow<n>]:TRACe<t>:X[:SCALe]:RPOSition.....	293
DISPlay[:WINDow<n>]:TRACe<t>:X[:SCALe]:RVALue.....	293
DISPlay[:WINDow<n>]:TRACe<t>:X[:SCALe]:START?.....	362
DISPlay[:WINDow<n>]:TRACe<t>:X[:SCALe]:VOFFset.....	312
DISPlay[:WINDow<n>]:TRACe<t>:Y[:SCALe]:AUTO:ALL.....	324
DISPlay[:WINDow<n>]:TRACe<t>[:STATe].....	333
DISPlay[:WINDow<n>]:ZOOM:AREA.....	347
DISPlay[:WINDow<n>]:ZOOM:MULTiple<zoom>:AREA.....	348
DISPlay[:WINDow<n>]:ZOOM:MULTiple<zoom>:STATe.....	349
DISPlay[:WINDow<n>]:ZOOM:STATe.....	348
FORMat:DEXPort:DSEParator.....	362
FORMat:DEXPort:HEADer.....	362
FORMat:DEXPort:MODE.....	362
INITiate:CONMeas.....	327
INITiate:CONTInuous.....	327
INITiate:REFMeas.....	329
INITiate:REFReSh.....	329
INITiate:SEQuencer:ABORT.....	330
INITiate:SEQuencer:IMMediate.....	330
INITiate:SEQuencer:MODE.....	330
INITiate:SEQuencer:REFReSh[:ALL].....	329
INITiate[:IMMediate].....	328
INPut:ATTenuation.....	288
INPut:ATTenuation:AUTO.....	289
INPut:ATTenuation:PROTection:RESet.....	279
INPut:COUPling.....	279
INPut:DIQ:CDEVice.....	282
INPut:DIQ:RANGe:AUTO.....	283
INPut:DIQ:RANGe:COUPling.....	283

INPut:DIQ:RANGe[:UPPer].....	283
INPut:DIQ:RANGe[:UPPer]:UNIT.....	284
INPut:DIQ:SRATe.....	284
INPut:DIQ:SRATe:AUTO.....	284
INPut:EATT.....	289
INPut:EATT:AUTO.....	290
INPut:EATT:STATe.....	290
INPut:FiLTer:HPASs[:STATe].....	280
INPut:FiLTer:YIG[:STATe].....	280
INPut:GAIn:STATe.....	288
INPut:GAIn:VALue].....	287
INPut:SElect.....	280
INSTRument:CREate:REPLace.....	262
INSTRument:CREate[:NEW].....	262
INSTRument:DELeTe.....	263
INSTRument:LIST?.....	263
INSTRument:REName.....	264
INSTRument[:SElect].....	264
LAYout:ADD[:WINDow]?.....	351
LAYout:CATalog[:WINDow]?.....	352
LAYout:IDENtify[:WINDow]?.....	352
LAYout:REMOve[:WINDow].....	352
LAYout:REPLace[:WINDow].....	353
LAYout:SPLitter.....	353
LAYout:WINDow<n>:ADD?.....	355
LAYout:WINDow<n>:IDENtify?.....	355
LAYout:WINDow<n>:REMOve.....	355
LAYout:WINDow<n>:REPLace.....	356
LAYout:WINDow<n>:TYPE?.....	356
MMEMory:LOAD:IQ:STATe.....	377
MMEMory:STORE:IQ:COMMeNt.....	377
MMEMory:STORE:IQ:FORMat?.....	378
MMEMory:STORE:IQ:STATe.....	378
MMEMory:STORE<n>:TRACe.....	363
STATus:QUEStionable:ACPLimit:CONDition?.....	386
STATus:QUEStionable:ACPLimit:ENABLe.....	387
STATus:QUEStionable:ACPLimit:NTRansition.....	387
STATus:QUEStionable:ACPLimit:PTRansition.....	388
STATus:QUEStionable:ACPLimit[:EVENT]?.....	386
STATus:QUEStionable:DIQ:CONDition?.....	386
STATus:QUEStionable:DIQ:ENABLe.....	387
STATus:QUEStionable:DIQ:NTRansition.....	387
STATus:QUEStionable:DIQ:PTRansition.....	388
STATus:QUEStionable:DIQ[:EVENT]?.....	386
STATus:QUEStionable:FREQuency:CONDition?.....	386
STATus:QUEStionable:FREQuency:ENABLe.....	387
STATus:QUEStionable:FREQuency:NTRansition.....	387
STATus:QUEStionable:FREQuency:PTRansition.....	388

STATus:QUESTionable:FREQuency[:EVENT]?	386
STATus:QUESTionable:LIMit<n>:CONDition?	386
STATus:QUESTionable:LIMit<n>:ENABle	387
STATus:QUESTionable:LIMit<n>:NTRansition	387
STATus:QUESTionable:LIMit<n>:PTRansition	388
STATus:QUESTionable:LIMit<n>[:EVENT]?	386
STATus:QUESTionable:LMARgin<n>:CONDition?	386
STATus:QUESTionable:LMARgin<n>:ENABle	387
STATus:QUESTionable:LMARgin<n>:NTRansition	387
STATus:QUESTionable:LMARgin<n>:PTRansition	388
STATus:QUESTionable:LMARgin<n>[:EVENT]?	386
STATus:QUESTionable:MODulation<n>:CFREquency:CONDition?	386
STATus:QUESTionable:MODulation<n>:CFREquency:ENABle	387
STATus:QUESTionable:MODulation<n>:CFREquency:NTRansition	387
STATus:QUESTionable:MODulation<n>:CFREquency:PTRansition	388
STATus:QUESTionable:MODulation<n>:CFREquency[:EVENT]?	386
STATus:QUESTionable:MODulation<n>:CONDition?	386
STATus:QUESTionable:MODulation<n>:ENABle	387
STATus:QUESTionable:MODulation<n>:EVM:CONDition?	386
STATus:QUESTionable:MODulation<n>:EVM:ENABle	387
STATus:QUESTionable:MODulation<n>:EVM:NTRansition	387
STATus:QUESTionable:MODulation<n>:EVM:PTRansition	388
STATus:QUESTionable:MODulation<n>:EVM[:EVENT]?	386
STATus:QUESTionable:MODulation<n>:FSK:CONDition?	386
STATus:QUESTionable:MODulation<n>:FSK:ENABle	387
STATus:QUESTionable:MODulation<n>:FSK:NTRansition	387
STATus:QUESTionable:MODulation<n>:FSK:PTRansition	388
STATus:QUESTionable:MODulation<n>:FSK[:EVENT]?	386
STATus:QUESTionable:MODulation<n>:IQRHo:CONDition?	386
STATus:QUESTionable:MODulation<n>:IQRHo:ENABle	387
STATus:QUESTionable:MODulation<n>:IQRHo:NTRansition	387
STATus:QUESTionable:MODulation<n>:IQRHo:PTRansition	388
STATus:QUESTionable:MODulation<n>:IQRHo[:EVENT]?	386
STATus:QUESTionable:MODulation<n>:MAGNitude:CONDition?	386
STATus:QUESTionable:MODulation<n>:MAGNitude:ENABle	387
STATus:QUESTionable:MODulation<n>:MAGNitude:NTRansition	387
STATus:QUESTionable:MODulation<n>:MAGNitude:PTRansition	388
STATus:QUESTionable:MODulation<n>:MAGNitude[:EVENT]?	386
STATus:QUESTionable:MODulation<n>:NTRansition	387
STATus:QUESTionable:MODulation<n>:PHASe:CONDition?	386
STATus:QUESTionable:MODulation<n>:PHASe:ENABle	387
STATus:QUESTionable:MODulation<n>:PHASe:NTRansition	387
STATus:QUESTionable:MODulation<n>:PHASe:PTRansition	388
STATus:QUESTionable:MODulation<n>:PHASe[:EVENT]?	386
STATus:QUESTionable:MODulation<n>:PTRansition	388
STATus:QUESTionable:MODulation<n>[:EVENT]?	386
STATus:QUESTionable:POWer:CONDition?	386
STATus:QUESTionable:POWer:ENABle	387



STATus:QUEStionable:POWer:NTRansition.....	388
STATus:QUEStionable:POWer:PTRansition.....	388
STATus:QUEStionable:POWer[:EVENT]?.....	386
STATus:QUEStionable:SYNC:CONDition?.....	386
STATus:QUEStionable:SYNC:ENABle.....	387
STATus:QUEStionable:SYNC:NTRansition.....	388
STATus:QUEStionable:SYNC:PTRansition.....	388
STATus:QUEStionable:SYNC[:EVENT]?.....	386
SYSTem:PRESet:CHANnel[:EXECute].....	264
SYSTem:SEQuencer.....	331
TRACe:IQ:WBAND[:STATe].....	297
TRACe<n>[:DATA].....	363
TRIGger[:SEQuence]:BBPower:HOLDoff.....	298
TRIGger[:SEQuence]:DTIME.....	298
TRIGger[:SEQuence]:HOLDoff[:TIME].....	299
TRIGger[:SEQuence]:IFPower:HOLDoff.....	299
TRIGger[:SEQuence]:IFPower:HYSteresis.....	299
TRIGger[:SEQuence]:LEVel:BBPower.....	300
TRIGger[:SEQuence]:LEVel:IFPower.....	300
TRIGger[:SEQuence]:LEVel:IQPower.....	300
TRIGger[:SEQuence]:LEVel[:EXtErnal<port>].....	300
TRIGger[:SEQuence]:SLOPe.....	301
TRIGger[:SEQuence]:SOURce.....	301
[SENSe:]ADJust:CONFigure:DURation.....	324
[SENSe:]ADJust:CONFigure:DURation:MODE.....	324
[SENSe:]ADJust:CONFigure:HYSteresis:LOWer.....	325
[SENSe:]ADJust:CONFigure:HYSteresis:UPPer.....	325
[SENSe:]ADJust:LEVel.....	326
[SENSe:]DDEMod:APSK:NState.....	269
[SENSe:]DDEMod:ASK:NState.....	269
[SENSe:]DDEMod:ECALc:OFFSet.....	313
[SENSe:]DDEMod:ECALc[:MODE].....	313
[SENSe:]DDEMod:EPRate:AUTO.....	314
[SENSe:]DDEMod:EPRate[:VALue].....	314
[SENSe:]DDEMod:EQUalizer:ADAPt.....	390
[SENSe:]DDEMod:EQUalizer:LENGth.....	314
[SENSe:]DDEMod:EQUalizer:LOAD.....	315
[SENSe:]DDEMod:EQUalizer:MODE.....	315
[SENSe:]DDEMod:EQUalizer:RESet.....	316
[SENSe:]DDEMod:EQUalizer:SAVE.....	316
[SENSe:]DDEMod:EQUalizer[:STATe].....	317
[SENSe:]DDEMod:FACTory[:VALue].....	265
[SENSe:]DDEMod:FILTer:ALPHa.....	269
[SENSe:]DDEMod:FILTer[:STATe].....	269
[SENSe:]DDEMod:FORMat.....	270
[SENSe:]DDEMod:FSK:NState.....	270
[SENSe:]DDEMod:FSYnc:AUTO.....	317
[SENSe:]DDEMod:FSYnc:LEVel.....	317

[SENSe:]DDEMod:FSYNc:RESult?	317
[SENSe:]DDEMod:FSYNc[:MODE]	317
[SENSe:]DDEMod:KDATa:STATe	318
[SENSe:]DDEMod:KDATa[:NAME]	318
[SENSe:]DDEMod:MAPPING:CATalog?	271
[SENSe:]DDEMod:MAPPING[:VALue]	271
[SENSe:]DDEMod:MFILter:ALPHa	321
[SENSe:]DDEMod:MFILter:AUTO	321
[SENSe:]DDEMod:MFILter:NAME	321
[SENSe:]DDEMod:MFILter:USER	322
[SENSe:]DDEMod:MFILter[:STATe]	321
[SENSe:]DDEMod:MSK:FORMat	271
[SENSe:]DDEMod:NORMalize:ADRoop	318
[SENSe:]DDEMod:NORMalize:CFDRift	319
[SENSe:]DDEMod:NORMalize:CHANnel	319
[SENSe:]DDEMod:NORMalize:FDERror	319
[SENSe:]DDEMod:NORMalize:IQIMbalance	319
[SENSe:]DDEMod:NORMalize:IQOFset	319
[SENSe:]DDEMod:NORMalize:SRError	320
[SENSe:]DDEMod:NORMalize[:VALue]	390
[SENSe:]DDEMod:PRATe	296
[SENSe:]DDEMod:PRESet:RLEVel	287
[SENSe:]DDEMod:PRESet:RLEVel	326
[SENSe:]DDEMod:PRESet[:STANdard]	265
[SENSe:]DDEMod:PSK:FORMat	272
[SENSe:]DDEMod:PSK:NSTate	272
[SENSe:]DDEMod:QAM:FORMat	272
[SENSe:]DDEMod:QAM:NSTate	273
[SENSe:]DDEMod:QPSK:FORMat	273
[SENSe:]DDEMod:RELENgth:AUTO	296
[SENSe:]DDEMod:RELENgth[:VALue]	296
[SENSe:]DDEMod:SBANd	297
[SENSe:]DDEMod:SEARch:BURSt:AUTO	304
[SENSe:]DDEMod:SEARch:BURSt:CONFIgure:AUTO	304
[SENSe:]DDEMod:SEARch:BURSt:GLENgth[:MINimum]	305
[SENSe:]DDEMod:SEARch:BURSt:LENgth:MAXimum	276
[SENSe:]DDEMod:SEARch:BURSt:LENgth[:MINimum]	276
[SENSe:]DDEMod:SEARch:BURSt:MODE	305
[SENSe:]DDEMod:SEARch:BURSt:SKIP:FALLing	277
[SENSe:]DDEMod:SEARch:BURSt:SKIP:RISing	277
[SENSe:]DDEMod:SEARch:BURSt:STATe	305
[SENSe:]DDEMod:SEARch:BURSt:TOLerance	305
[SENSe:]DDEMod:SEARch:MBURst:CALC	303
[SENSe:]DDEMod:SEARch:PATTerN:CONFIgure:AUTO	306
[SENSe:]DDEMod:SEARch:PATTerN:SYNC:AUTO	320
[SENSe:]DDEMod:SEARch:PATTerN:SYNC[:STATe]	320
[SENSe:]DDEMod:SEARch:SYNC:AUTO	306
[SENSe:]DDEMod:SEARch:SYNC:CATalog	277

[SENSe:]DDEMod:SEARch:SYNC:COMMeNt.....	308
[SENSe:]DDEMod:SEARch:SYNC:COpy.....	308
[SENSe:]DDEMod:SEARch:SYNC:DATA.....	309
[SENSe:]DDEMod:SEARch:SYNC:DELeTe.....	308
[SENSe:]DDEMod:SEARch:SYNC:IQThreShold.....	306
[SENSe:]DDEMod:SEARch:SYNC:MODe.....	307
[SENSe:]DDEMod:SEARch:SYNC:NAme.....	309
[SENSe:]DDEMod:SEARch:SYNC:NStAtE.....	309
[SENSe:]DDEMod:SEARch:SYNC:PATTeRn:ADD.....	310
[SENSe:]DDEMod:SEARch:SYNC:PATTeRn:REMOve.....	310
[SENSe:]DDEMod:SEARch:SYNC:SELeCt.....	307
[SENSe:]DDEMod:SEARch:SYNC:StAtE.....	307
[SENSe:]DDEMod:SEARch:SYNC:TEXT.....	310
[SENSe:]DDEMod:SIGNal:PATTeRn.....	278
[SENSe:]DDEMod:SIGNal[:VALue].....	278
[SENSe:]DDEMod:SRAtE.....	274
[SENSe:]DDEMod:STANdard:COMMeNt.....	266
[SENSe:]DDEMod:STANdard:DELeTe.....	266
[SENSe:]DDEMod:STANdard:PRESet[:VALue].....	266
[SENSe:]DDEMod:STANdard:SAVE.....	267
[SENSe:]DDEMod:STANdard:SYNC:OFFSet:StAtE.....	278
[SENSe:]DDEMod:STANdard:SYNC:OFFSet[:VALue].....	278
[SENSe:]DDEMod:TFILteR:ALPHa.....	274
[SENSe:]DDEMod:TFILteR:NAme.....	275
[SENSe:]DDEMod:TFILteR:USER.....	275
[SENSe:]DDEMod:TFILteR[:StAtE].....	275
[SENSe:]DDEMod:TIME.....	312
[SENSe:]DDEMod:USER:NAme.....	275
[SENSe:]FREQuency:CENTer.....	285
[SENSe:]FREQuency:CENTer:StEP.....	285
[SENSe:]FREQuency:CENTer:StEP:AUTO.....	285
[SENSe:]FREQuency:OFFSet.....	286
[SENSe:]MSRA:CAPTuRe:OFFSet.....	302
[SENSe:]SWEp:COUNt:CURReNt.....	303
[SENSe:]SWEp:COUNt[:VALue].....	303

# Index

## Symbols

4ASK	
Constellation diagram	81
8PSK	
Constellation diagram	66
16APSK	
Constellation diagram	82
95%ile	
Formula	415

## A

Aborting	
Sweep	158, 159
AC/DC coupling	135, 145
Activating	
VSA (remote)	262
Alignment	
Result range	171
Alpha/BT	130, 181
Amplitude	
Configuration (remote)	286
Configuration (softkey)	143
Distortion, effect	103
Settings	143
Amplitude droop	
Compensation	173
Definition	102
Formula	413
Analysis	
Bandwidth, definition	61
Button	185
Analysis interval	
MSRA	152, 295
Analyzing	
Measured data	212
APSK	
Modulation type	127
Symbol mapping	82
ASCII Trace export	406
ASK	
Modulation type	127
Symbol mapping	81
Attenuation	140, 145
Auto	140, 145
Configuration (remote)	288
Electronic	141, 146
Manual	140, 145
Option B25	141, 146
Protective (remote)	279
Auto level	
Hysteresis	184
Reference level	140, 144, 183
Softkey	140, 144, 183
Automatic	
Configuration	183
Configuration (remote)	323
Auto settings	
Meastime Auto (softkey)	183
Meastime Manual (softkey)	183
Averaging	
Measurements	162, 164, 167

## B

Bandwidth	
Coverage, MSRA mode	118
Demodulation	51
depending on sample rate	62
Digital I/Q data	61
Extension	153
Extension options	58, 59
Maximum	153
Maximum usable	58
Relationship to sample rate	59
Signal processing	50
Usable (max.)	58
BB Power	
Trigger (softkey)	156
Bit error rate (BER)	
Result type	42
Burst GSM EDGE	
Measurement example	228
Bursts	
Display	13
Length (min/max)	132
Programming example	392
Reference for result range	170
Run-in	132
Signal structure	132
Useful length	114
Burst search	
Algorithm	88
Auto configuration	162
Configuration	161
Demodulation process	85
Enabling	162
Errors	239
Gap length	162
Parameters	86
Process	86
Remote	304
Robustness	87
Tolerance	162
Burst signal	132

## C

Capture buffer	
Data source	16
Length	111
Navigating	226
Reference for result range	170
Result types	16
Capture Buffer	
Display	116
Capture length	
Data acquisition	152
Display	13
Capture offset	
MSRA applications	158
Remote	302
Softkey	158
Capture oversampling	
see Sample rate	57

- Carrier frequency drift
  - Compensation ..... 174
  - Definition ..... 110
  - Formula ..... 414
- Carrier frequency error
  - Formula ..... 414
- Center frequency ..... 139, 142
  - Softkey ..... 139, 142
  - Step size ..... 142
- Channel bandwidth
  - MSRA mode ..... 118
- Channel Frequency Response Magnitude
  - Result type ..... 47
- Channel Group Delay
  - Result type ..... 48
- Clock rate
  - Definition ..... 61
- Coarse Synchronization ..... 177
- Compatible
  - Patterns ..... 166
- Compensation
  - Demodulation ..... 172, 173
  - Modulation errors ..... 98
  - Remote ..... 312
- Constellation
  - Frequency (result type) ..... 32
- Constellation I/Q
  - Result type ..... 30
  - Rotated, Result type ..... 30
- Constellation points
  - Symbol mapping ..... 63
- Continue single sweep
  - Softkey ..... 159
- Continuous signal ..... 132
- Continuous sweep
  - Softkey ..... 158
- Couple Screens
  - Softkey ..... 191
- Coupling
  - Input (remote) ..... 279
- Customized
  - Measurement, performing ..... 203
- D**
- Data acquisition
  - Capture length ..... 152
  - Configuration ..... 151
  - MSRA ..... 152, 295
  - Sample rate ..... 153
  - Usable I/Q Bandwidth ..... 153
- Data source
  - Capture buffer ..... 16
  - Display ..... 14
  - Equalizer ..... 18
  - Error vector ..... 17
  - Evaluation method ..... 15
  - Meas & Ref ..... 16
  - Modulation accuracy ..... 18
  - Modulation errors ..... 17
  - Result types ..... 19
  - Symbols ..... 17
- Decimal separator
  - Trace export ..... 189
- Default values
  - Preset ..... 120
  - Scaling ..... 149
- Deleting
  - Settings files ..... 123
  - Standards ..... 123
- Delta markers
  - Defining ..... 191
- Demodulation
  - Advanced ..... 175
  - Bandwidth ..... 51
  - Compensation ..... 172, 173
  - Configuration ..... 171
  - Estimation points per symbol ..... 177
  - Known data ..... 117
  - Normalization ..... 176
  - Offset EVM ..... 179
  - Process ..... 84
  - Remote ..... 312
  - Synchronization ..... 175, 177, 178
- Diagram footer information ..... 14
- Differential PSK (DPSK)
  - Symbol mapping ..... 68
- DigiConf
  - Softkey, see also R&S DigiConf ..... 138
- Digital Baseband Interface (B17)
  - Input settings ..... 136
  - Input status (remote) ..... 282
- Digital I/Q
  - Bandwidths ..... 61
  - Input connection information ..... 138
  - Input settings ..... 136
  - Sample rates ..... 61
- Digital input
  - Bandwidths ..... 62
  - Connection information ..... 138
  - Restrictions ..... 62
- Digital output
  - Restrictions ..... 62
- Digital standards
  - Assigned patterns ..... 165
  - Assigning patterns ..... 166
  - Configuration ..... 121
  - Performing measurement according to ..... 201
  - Predefined ..... 398
  - Remote ..... 265
  - Removing assigned patterns ..... 165
  - Saving ..... 123
  - Selecting ..... 122
  - Softkey ..... 122
  - VSA measurements ..... 121
- Display
  - Configuration (softkey) ..... 196
  - Information ..... 12
  - Points per symbol ..... 115, 198, 410, 412
- Drop-out time
  - Trigger ..... 157
- E**
- EDGE
  - Filters, frequency response ..... 418
  - Measurement example ..... 228
- Electronic input attenuation ..... 140, 141, 145, 146
- Equalizer
  - Basics ..... 93
  - Data source ..... 18
  - Loading ..... 175
  - MSRA mode ..... 118

Result types .....	18	High-pass (RF input) .....	135
Storing .....	175	Measurement .....	52, 53, 404
Error log .....	255	Measurement (formulae) .....	418
Error messages		Predefined .....	404
Explanation .....	239	Receive .....	52
Error model		Reference .....	52
FSK .....	107	Signal processing .....	50
PSK, QAM, MSK .....	96	Standard-specific (formulae) .....	417
Error vector		Transmit .....	52, 404
Data source .....	17	Transmit (formulae) .....	417
Definition .....	98	Typical combinations .....	405
Formula .....	410	YIG (remote) .....	280
Result types .....	17	FILTWIZ .....	55
Error Vector Magnitude (EVM)		Fine Synchronization .....	178
Definition .....	98	Folders	
Formula .....	410	Digital standards .....	122
Result type .....	34	Formulae	
RMS, peak (formulae) .....	413	Analytically calculated filters .....	416
Estimation		Evaluation .....	410
Algorithms .....	96	Measurement filters .....	418
FSK .....	109	Parameters .....	410
Points per symbol .....	97, 115, 177	Result Summary parameters .....	413
PSK, QAM, MSK .....	97	Result Summary parameters (FSK) .....	414
Ranges .....	97	Standard-specific filters .....	417
Evaluation		Statistics .....	415
Refreshing .....	159	Trace averaging .....	416
Specific range .....	160	Transmit filters .....	417
Traces .....	187	Free Run	
Evaluation methods		Trigger (softkey) .....	155
Data source .....	15	Frequency	
Remote .....	351	Absolute (result type) .....	24
Evaluation range		Configuration (remote) .....	284
Configuration .....	181	Configuration (softkey) .....	141
Configuration (remote) .....	322	Formula .....	410
Definition .....	114	Relative (result type) .....	25
Display .....	114	Frequency error	
Entire result range .....	182	Absolute (result type) .....	37
Start/stop values .....	182	Formula .....	410
Export format .....	406	Relative (result type) .....	38
Exporting		RMS, peak (formulae) .....	414
I/Q data .....	119	Frequency offset .....	142
I/Q data (remote) .....	377	Frequency response	
Trace data .....	217	Channel (result type) .....	47
External trigger		EDGE filters .....	418
Level (remote) .....	300	Low-ISI filters .....	420
Softkey .....	155	Magnitude (result type) .....	45
Eye diagram		Phase (result type) .....	46
Frequency (result type) .....	29	Frequency shift keying (FSK)	
Imag (Q) (result type) .....	28	Symbol mapping .....	73
Real (I) (result type) .....	27	Frontend	
<b>F</b>		Configuration .....	134
Factory settings		Configuration (remote) .....	279
Restoring .....	121	Settings .....	138
File name		FSK	
Settings .....	122	Calculating errors .....	411
Filter bandwidth (BT)		Compensation .....	411
Measurement filter .....	181	Deviation error (formula) .....	414
Transmit filter .....	130	Error model .....	107
Filters		Estimation .....	109
(De-)Modulation .....	52	Measurement deviation (formula) .....	414
Customized .....	55	Modulation type .....	127
Customized, creating .....	55	Reference deviation .....	129
Customized, selecting .....	204	Signal model .....	106
Formulae .....	416	FSK deviation error	
High-pass (remote) .....	280	Compensation .....	174
		Definition .....	110

- FSK reference deviation
  - Formula ..... 414
- Full scale level
  - Digital I/Q ..... 137
  - Digital I/Q (remote) ..... 283
  - Unit, digital I/Q (remote) ..... 284
- G**
- Gain distortion
  - Effect ..... 103
- Gain imbalance
  - Definition ..... 101
  - Effect ..... 101
  - Formula ..... 413
  - Preconditions for measurement ..... 101
- Gating ..... 226
- Group delay
  - Channel (result type) ..... 48
  - Result type ..... 46
- GSM
  - Programming example ..... 392
- H**
- Hardware settings
  - Displayed ..... 13
- High-pass filter
  - Remote ..... 280
  - RF input ..... 135
- Hysteresis
  - Lower (Auto level) ..... 184
  - Trigger ..... 157
  - Upper (Auto level) ..... 184
- I**
- I/Q bandwidth
  - Usable ..... 51, 153
- I/Q correlation threshold
  - Pattern search ..... 164
- I/Q data
  - Exporting ..... 119
  - Exporting (remote) ..... 377
  - Importing ..... 119
  - Importing (remote) ..... 377
  - Maximum bandwidth ..... 58
  - Sample rate ..... 58
- I/Q imbalance
  - Compensation ..... 173
  - Definition ..... 102
  - Formula ..... 413
- I/Q offset
  - (Origin Offset) Definition ..... 100
  - Compensating ..... 100
  - Compensation ..... 173
  - Formula ..... 413
- I/Q pattern search
  - see Pattern search ..... 88
- I/Q Power
  - Trigger (softkey) ..... 156
  - Trigger level (remote) ..... 300
- IF Power
  - Trigger (softkey) ..... 156
  - Trigger level (remote) ..... 300
- IF WIDE OUTPUT
  - Connector ..... 153
- Importing
  - I/Q data ..... 119
  - I/Q data (remote) ..... 377
- Impulse response
  - Magnitude (result type) ..... 44
  - Phase (result type) ..... 44
  - Real/Imag (result type) ..... 45
- Input
  - Configuration ..... 134
  - Configuration (remote) ..... 279
  - Coupling ..... 135, 145
  - Coupling (remote) ..... 279
  - Digital Baseband Interface (B17) settings ..... 136
  - Overload (remote) ..... 279
  - RF ..... 135
  - Settings ..... 134, 145
  - Source, digital I/Q ..... 137
  - Source Configuration (softkey) ..... 134
  - Source Configuration (Softkey) ..... 134
- Input/Frontend
  - Softkey ..... 134
- Input sample rate (ISR)
  - Definition ..... 61
  - Digital I/Q ..... 137
- Input sources
  - Radio frequency ..... 134
- Installation ..... 11
- Intersymbol interference (ISI) ..... 52
  - Filter ..... 52
- ISI-free system ..... 53
- K**
- Keys
  - BW (not used) ..... 119
  - MKR -> ..... 193
  - MKR FUNCT (not used) ..... 119
  - Peak Search ..... 193
  - RUN CONT ..... 158
  - RUN SINGLE ..... 159
  - SPAN (not used) ..... 119
- Known data ..... 133
  - Creating files ..... 209
  - Dependencies, restrictions ..... 116
  - Enabling ..... 134
  - Files ..... 208
  - File syntax ..... 408
  - Fine synchronization ..... 178, 179
  - Loading ..... 134
  - Recording tool ..... 209
  - Symbol decisions ..... 90
  - Working with ..... 208
- L**
- Limit lines
  - Current/mean/peak values ..... 195
  - Default ..... 195
  - Enabling ..... 195
  - Modulation accuracy ..... 194
  - Peak search ..... 193
  - Values ..... 195
  - Values, checking ..... 196
- Limits
  - Configuring ..... 216
  - Defining (remote) ..... 343

- Modulation Accuracy ..... 216
- Retrieving check results (remote) ..... 375
- Linear average
  - Formula ..... 416
- Lines
  - Limit checking ..... 194
- Loading
  - Settings files ..... 122
- Lower Level Hysteresis
  - Softkey ..... 184
- Low-ISI filters
  - Frequency response ..... 420
- M**
- Magnitude
  - Formula ..... 410
- Magnitude absolute
  - Result type ..... 21
- Magnitude Absolute
  - Result type ..... 21
- Magnitude error
  - Definition ..... 99
  - Formula ..... 410
  - Result type ..... 35, 36
  - RMS, peak (formulae) ..... 413, 414
- Magnitude Relative
  - Result type ..... 22
- Mapping
  - see Symbol mapping ..... 63
- Mapping wizard (mapwiz) ..... 83
- Markers
  - Absolute peak ..... 193
  - Assigned trace ..... 191
  - Configuring ..... 189
  - Configuring (softkey) ..... 189
  - Coupling ..... 191
  - Deactivating ..... 191
  - Delta markers ..... 191
  - General settings (remote) ..... 337
  - Minimum ..... 193
  - Next minimum ..... 194
  - Next peak ..... 193
  - Peak ..... 193
  - Positioning ..... 193
  - Querying position (remote) ..... 361
  - Retrieving values (remote) ..... 361
  - Search settings ..... 191
  - Settings (remote) ..... 334
  - State ..... 190
  - Stimulus ..... 190
  - Type ..... 191
  - X-value ..... 190
- Marker to Trace
  - Softkey ..... 191
- Matched filter ..... 52
- Maximizing
  - Windows (remote) ..... 350
- Max Peak
  - Softkey ..... 193
- Mean
  - Formula ..... 415
- Meas & Ref
  - Data source ..... 16
  - Result types ..... 16
- MEAS filter ..... 52
- Meas only if burst was found ..... 162
- Measurement bandwidth ..... 51
- Measurement channel
  - Creating (remote) ..... 262
  - Deleting (remote) ..... 263
  - Querying (remote) ..... 263
  - Renaming (remote) ..... 264
  - Replacing (remote) ..... 262
- Measurement example
  - Burst GSM EDGE Signals ..... 228
  - Continuous QPSK ..... 220
- Measurement examples
  - Burst GSM EDGE signal (remote) ..... 392
  - Continuous QPSK signal (remote) ..... 391
- Measurement filter ..... 53
  - Alpha/BT ..... 181
  - Configuration ..... 179
  - Configuration (remote) ..... 320
  - Demodulation process ..... 86
  - Enabling ..... 180
  - Loading ..... 181
  - Predefined ..... 180, 404, 405
  - Type ..... 180
  - User-defined ..... 181
- Measurement ranges
  - Comparison ..... 111
  - Definition ..... 111
- Measurement signal
  - Evaluating ..... 187
- Measurement time
  - Auto settings ..... 183
- Min/max values
  - Y-axis ..... 148
- Min Gap Length
  - Bursts ..... 162
- Minimum
  - Marker positioning ..... 193
  - Next ..... 194
  - Softkey ..... 193
- Minimum shift keying (MSK)
  - Symbol mapping ..... 75
- MKR ->
  - Key ..... 193
- ModAcc Limits
  - Softkey ..... 195
- Modulation
  - Configuration ..... 126
  - Display ..... 13
  - Errors, FSK ..... 110
  - Mapping ..... 129
  - Order ..... 128
  - Remote ..... 268
  - Symbol Rate ..... 129
  - Type ..... 127
  - User-defined ..... 83
- Modulation accuracy
  - Data source ..... 18
  - Limit checking ..... 194
  - Limit checking, enabling ..... 195
  - Limit lines (remote) ..... 342
  - Limits ..... 216
  - Result types ..... 18
- Modulation Error Ratio (MER)
  - Definition ..... 99
- Modulation errors ..... 96, 98
  - Data source ..... 17
  - Formula ..... 413



PSK, QAM, MSK .....	96
Result types .....	17
Modulation order	
Known data .....	117
Pattern symbols .....	169
Modulation type	
FSK .....	106
MSK	
Error model .....	96
Modulation type .....	127
MSRA	
Analysis interval .....	152, 295
Operating mode .....	118
Trigger .....	155, 298
MSRA applications	
Capture offset .....	158
Capture offset (remote) .....	302
Multiple	
Measurement channels .....	12
Multiple zoom .....	200
<b>N</b>	
Next Minimum	
Marker positioning .....	194
Softkey .....	194
Next Peak	
Marker positioning .....	193
Softkey .....	193
Noise	
Effect .....	105
Normalization	
Demodulation .....	176
<b>O</b>	
Offset	
Analysis interval .....	158
EVM .....	179
Frequency .....	142
Pattern .....	133
QPSK .....	71
QPSK, symbol mapping .....	71
Reference level .....	140, 144
Result range .....	171
On Off Keying (OOK)	
Constellation diagram .....	81
OOK	
Symbol mapping .....	81
Options	
B13 .....	135, 280
B160 .....	153
B25 .....	141, 146
Bandwidth extension .....	58, 59, 153
U160 .....	153
OQPSK	
Constellation diagram .....	72
Output	
Configuration .....	134
Sample rate, definition .....	61
Overload	
RF input (remote) .....	279
Oversampling	
Statistics .....	198
Overview	
Configuration .....	123

**P**

Parameters	
Description .....	48, 49
FSK .....	49
PSK, QAM, MSK .....	48
Retrieving results (remote) .....	365
SCPI parameters .....	48, 49
Patterns	132
Adding to standard .....	166
Assigning to standard .....	205
Available .....	166
Coarse synchronization .....	177
Compatible .....	166
Configuration .....	132, 164
Copying .....	166
Creating .....	166
Definition .....	167
Definition (remote) .....	307
Deleting .....	167
Details .....	167
Displaying .....	166
Editing .....	166
Enabling .....	164, 167
Fine synchronization .....	178
Managing .....	207
Name .....	132, 168
Offset .....	133
Prefix .....	166
Reference for result range .....	170
Removing from standard .....	165
Restoring .....	121
Standard .....	165
Symbol check .....	92
Symbol check (demodulation process) .....	85
Symbol format .....	169
Symbols .....	169
Working with .....	204
Pattern search	
Configuration .....	163
Demodulation process .....	85
Display .....	13
Enabling .....	163, 167
Errors .....	239
Found pattern .....	164
I/Q correlation threshold .....	164
Performing .....	204
Process .....	88
Remote .....	306
Selected pattern .....	164
Peaks	
Absolute .....	193
Formula .....	415
Marker positioning .....	193
Next .....	193
Softkey .....	193
Peak search	
Key .....	193
Limits .....	193
Mode .....	192
Phase	
Distortion, effect .....	104
Formula .....	410
Wrap (result type) .....	22
Phase error	
Definition .....	99
Formula .....	410

- Result type ..... 36
- RMS, peak (formulae) ..... 413
- Phase Error
  - Result type ..... 37
- Phase shift keying
  - see PSK ..... 64
- Phase unwrap
  - Unwrap (result type) ..... 23
- Preamplifier
  - Setting ..... 136, 145
  - Softkey ..... 136, 145
- Prefix
  - Patterns ..... 166
- Presetting
  - Channels ..... 125
  - Default values ..... 120
- Pre-trigger ..... 157
- Programming examples
  - Burst GSM EDGE signal ..... 392
  - Continuous QPSK signal ..... 391
- Protection
  - RF input (remote) ..... 279
- PSK
  - Differential ..... 68
  - Error model ..... 96
  - Mixed forms ..... 70
  - Modulation type ..... 127
  - Rotating ..... 67
  - Rotating differential ..... 70
  - Symbol mapping ..... 64
- Q**
- QAM
  - Error model ..... 96
  - Modulation type ..... 127
  - Symbol mapping ..... 76
- QPSK
  - Continuous ..... 220
  - Measurement example ..... 220
  - Offset ..... 71
  - Offset, symbol mapping ..... 71
  - Programming example ..... 391
- Quadrature Amplitude Modulation
  - see QAM ..... 76
- Quadrature error
  - Definition ..... 102
  - Effect ..... 102
  - Formula ..... 413
  - Preconditions for measurement ..... 101
- Quick Config
  - Traces ..... 187
- R**
- R&S DigiConf ..... 138
- R&S EX-IQ-BOX
  - DigiConf ..... 138
- Range
  - X-axis ..... 149
- Range per division
  - Y-axis ..... 148
- Raw data
  - Exporting ..... 188
- Real/Imag (I/Q)
  - Result type ..... 26
- Receive filter ..... 52
- Recording tool
  - Known data ..... 209
- Reference
  - Result range ..... 170
- Reference deviation
  - Definition ..... 107
  - FSK ..... 129
- Reference filter ..... 52
- Reference level
  - Auto level ..... 140, 144, 183
  - Digital I/Q ..... 138
  - Offset ..... 140, 144
  - Offset (softkey) ..... 140, 144
  - Softkey ..... 139, 144
  - Unit ..... 139, 144
  - Value ..... 139, 144
- Reference position
  - X-axis ..... 149
  - Y-axis ..... 148
- Reference signal ..... 97
  - Demodulation process ..... 86
  - Evaluating ..... 187
  - Generating ..... 86
- Reference value
  - X-axis ..... 149
  - Y-axis ..... 148
- Refresh
  - Softkey ..... 159
- Refreshing
  - MSRA applications ..... 160
  - MSRA applications (remote) ..... 329
  - Softkey ..... 160
- Remote commands
  - Basics on syntax ..... 257
  - Boolean values ..... 260
  - Capitalization ..... 258
  - Character data ..... 261
  - Data blocks ..... 261
  - Numeric values ..... 260
  - Optional keywords ..... 259
  - Parameters ..... 259
  - Strings ..... 261
  - Suffixes ..... 258
- Resetting
  - RF input protection ..... 279
- Restoring
  - Channel settings ..... 125
  - Factory Settings (softkey) ..... 121
  - Pattern files ..... 121
  - Standard files ..... 121, 123
- Result display
  - Configuration (remote) ..... 349
  - Troubleshooting ..... 248
- Result displays
  - Data sources ..... 15
- Result length
  - Display ..... 13
  - Known data ..... 117
  - QAM modulation ..... 76
  - Ranges ..... 170
- Result range
  - Alignment ..... 113, 171
  - Alignment (known data) ..... 117
  - Configuration ..... 169
  - Defining ..... 211
  - Definition ..... 112
  - Demodulation process ..... 85

- Display ..... 112
- Evaluating ..... 182
- Length ..... 113, 170
- Offset ..... 171
- Overlapping ..... 248
- Reference ..... 170
- Remote ..... 310
- Run-In/out ..... 114
- Selecting ..... 160
- Results
  - Retrieving (remote) ..... 360
  - Updating the display ..... 160
  - Updating the display (remote) ..... 329
- Result Summary
  - Display points per symbol ..... 116
  - Evaluations ..... 412
  - Formulae ..... 413
  - Formulae (FSK) ..... 414
  - Result type ..... 39
- Result type
  - Display ..... 14
  - Transformation ..... 197
  - Window configuration ..... 197
- Result types
  - Bit error rate (BER) ..... 42
  - Capture buffer ..... 16
  - Channel Frequency Response Magnitude ..... 47
  - Channel Group Delay ..... 48
  - Constellation Frequency ..... 32
  - Constellation I/Q ..... 30
  - Constellation I/Q (Rotated) ..... 30
  - Equalizer ..... 18
  - Error vector ..... 17
  - Error Vector Magnitude (EVM) ..... 34
  - Eye Diagram Frequency ..... 29
  - Eye Diagram Imag (Q) ..... 28
  - Eye Diagram Real (I) ..... 27
  - Frequency Absolute ..... 24
  - Frequency Error Absolute ..... 37
  - Frequency Error Relative ..... 38
  - Frequency Relative ..... 25
  - Frequency Response Magnitude ..... 45
  - Frequency Response Phase ..... 46
  - Group Delay ..... 46
  - Impulse Response Magnitude ..... 44
  - Impulse Response Phase ..... 44
  - Impulse Response Real/Imag ..... 45
  - Magnitude Absolute ..... 21
  - Magnitude Error ..... 35
  - Magnitude Relative ..... 22
  - Meas & Ref ..... 16
  - Modulation accuracy ..... 18
  - Modulation errors ..... 17
  - Overview ..... 19
  - Phase Error ..... 36
  - Phase Unwrap ..... 23
  - Phase Wrap ..... 22
  - Real/Imag (I/Q) ..... 26
  - Result Summary ..... 39
  - SCPI parameters ..... 19
  - Symbols ..... 17
  - Symbol Table ..... 33
  - Vector Frequency ..... 33
  - Vector I/Q ..... 31
- RF attenuation
  - Auto (softkey) ..... 140, 145
  - Manual (softkey) ..... 140, 145
- RF input ..... 134
  - Overload protection (remote) ..... 279
  - Remote ..... 279, 280
- RHO
  - Formula ..... 413
- RMS average
  - Formula ..... 416
- Roll-off factor (Alpha)
  - Measurement filter ..... 181
  - Transmit filter ..... 130
- Rotating Differential PSK
  - Symbol mapping ..... 70
- Rotating PSK
  - Symbol mapping ..... 67
- RRC filter ..... 52
- RUN CONT
  - Key ..... 158
- Run-in
  - Bursts ..... 132
- RUN SINGLE
  - Key ..... 159
- S**
  - Sample rate ..... 51, 115
    - Basics ..... 50
    - Definition ..... 57, 61
    - Digital I/Q ..... 137
    - Digital I/Q (remote) ..... 284
    - Digital I/Q data ..... 61
    - Max. usable I/Q bandwidth ..... 58
    - Maximum ..... 58
    - Relationship to bandwidth ..... 59
    - Relationship to symbol rate ..... 58
    - Remote ..... 296
    - Setting ..... 153
  - Saving
    - Settings ..... 123
    - Settings as standard ..... 123
  - Scaling
    - Automatically ..... 148, 184
    - Diagrams, changing ..... 213
    - X-axis ..... 146, 214
    - X-axis, y-axis (default) ..... 149
    - X-axis (automatically) ..... 149
    - Y-axis ..... 146, 213, 214
    - Y-axis (remote control) ..... 294
    - Y-axis (statistics) ..... 148
  - Search
    - Direction (Real or Imag) ..... 192
    - Tolerance (Burst Search) ..... 162
  - Search limits
    - Activating ..... 193
  - Select Result Rng
    - Softkey ..... 160
  - Sequencer ..... 12
    - Aborting (remote) ..... 330
    - Activating (remote) ..... 330
    - Mode (remote) ..... 330
    - Remote ..... 327
  - Settings
    - File name ..... 122
    - Restoring files ..... 121, 123
    - Saving ..... 123
    - Storage location ..... 122

- Settings files
  - Deleting ..... 123
  - Loading ..... 122
  - Saving ..... 123
- Sidebands
  - Inverting ..... 153
- Signal capture
  - Remote control ..... 295
  - Softkey ..... 151
- Signal description
  - Configuration ..... 126
  - Configuration (remote) ..... 267
  - Pattern ..... 132
  - Softkey ..... 126
- Signal model ..... 96
  - FSK ..... 106
- Signal source
  - Remote ..... 280
- Signal structure
  - Burst settings ..... 132
  - Configuration ..... 130
  - Remote ..... 276
- Signal type
  - Continuous/Burst Signal ..... 132
- Single sweep
  - Softkey ..... 159
- Single zoom ..... 200
- Slope
  - Trigger ..... 157, 301
- Slow/I/Q ..... 62
- Softkeys
  - Amplitude Config ..... 143
  - Auto Level ..... 140, 144, 183
  - BB Power ..... 156
  - Capture Offset ..... 158
  - Center ..... 139, 142
  - Continue Single Sweep ..... 159
  - Continuous Sweep ..... 158
  - DigiConf ..... 138
  - Display configuration ..... 196
  - External ..... 155
  - Free Run ..... 155
  - Frequency Config ..... 141
  - I/Q Power ..... 156
  - IF Power ..... 156
  - Input/Frontend ..... 134
  - Input Source Config ..... 134
  - Lower Level Hysteresis ..... 184
  - Marker Config ..... 189
  - Marker to Trace ..... 191
  - Meastime Auto ..... 183
  - Meastime Manual ..... 183
  - Min ..... 193
  - ModAcc Limits ..... 195
  - Next Min ..... 194
  - Next Peak ..... 193
  - Norm/Delta ..... 191
  - Peak ..... 193
  - Preamp ..... 136, 145
  - Ref Level ..... 139, 144
  - Ref Level Offset ..... 140, 144
  - Refresh ..... 160
  - RF Atten Auto ..... 140, 145
  - RF Atten Manual ..... 140, 145
  - Signal Capture ..... 151
  - Signal Description ..... 126
  - Single Sweep ..... 159
  - Trace 1/2/3/4 ..... 187
  - Trace Config ..... 185
  - Trigger/Gate Config ..... 154
  - Trigger Offset ..... 157
  - Upper Level Hysteresis ..... 184
  - Window configuration ..... 196
- Specifics for
  - Configuration ..... 125
- Spectrum
  - Result type transformation ..... 197
- SR
  - see Symbol rate ..... 13
- Standards
  - see Digital standards ..... 121
- Statistic count ..... 159
  - Display ..... 13
- Statistics
  - Formulae ..... 415
  - Oversampling ..... 198
  - Result type transformation ..... 197
- Status registers
  - Description ..... 379
  - Querying ..... 384
  - STAT:QUES:POW ..... 279
- Status reporting system ..... 378
- StdDev
  - Formula ..... 415
- Stimulus
  - Marker ..... 190
- Storage location
  - Settings ..... 122
- Suffixes
  - Remote commands ..... 258
- Support ..... 255
- Swap I/Q ..... 153
- Sweep
  - Aborting ..... 158, 159
  - Configuration (remote) ..... 303, 326
  - Count, see Statistic count ..... 159
  - Settings ..... 158
- Symbol check
  - Algorithm ..... 92
  - Demodulation ..... 92
  - Patterns ..... 92
- Symbol decisions
  - Algorithm ..... 89
  - Demodulation ..... 89
  - Demodulation process ..... 85
  - Known data ..... 90
- Symbol error rate (SER)
  - Fine synchronization ..... 179
- Symbol mapping ..... 63, 129
  - APSK ..... 82
  - ASK ..... 81
  - Differential PSK ..... 68
  - FSK ..... 73
  - MSK ..... 75
  - Offset QPSK ..... 71
  - OOK ..... 81
  - PSK ..... 64
  - QAM ..... 76
  - Rotating differentialPSK ..... 70
  - Rotating PSK ..... 67
  - User-defined ..... 83
  - Wizard (mapwiz) ..... 83
- Symbol number
  - Result range start ..... 171

- Symbol rate ..... 115, 129
  - Basics ..... 50
  - Display ..... 13
  - MSRA mode ..... 118
  - Relationship to sample rate ..... 58
  - Remote ..... 274
- Symbol Rate Error ..... 173
- Symbols
  - Data source ..... 17
  - Format, patterns ..... 169
  - Highlighting ..... 198
  - Patterns ..... 169
  - Result types ..... 17
  - Window Configuration ..... 198
- Symbol tables
  - Result type ..... 33
- Synchronization ..... 97
  - Coarse ..... 177
  - Demodulation ..... 175
  - Demodulation process ..... 86
  - Fine ..... 178
  - Known data ..... 178, 179
  - Patterns ..... 177, 178
  - Remote ..... 312
  - Symbol error rate (SER) ..... 179
- Syntax
  - Known data files ..... 408
- T**
- Trace Export
  - Configuration ..... 188
  - Data mode ..... 188
  - Header information ..... 188
  - Storage location ..... 189
- Traces
  - Averaging, formulae ..... 416
  - Configuration (Softkey) ..... 185
  - Configuring (remote control) ..... 332
  - Evaluation ..... 187
  - Export format ..... 189
  - Exporting ..... 189
  - Exporting data ..... 217
  - Measurement signal ..... 187
  - Mode ..... 186
  - Mode (remote) ..... 333
  - Reference signal ..... 187
  - Retrieving data (remote) ..... 361
  - Selecting ..... 186
  - Settings, predefined ..... 187
  - Settings (remote control) ..... 332
  - Softkeys ..... 187
  - Troubleshooting ..... 248
- Transmit filter ..... 52
  - Alpha/BT ..... 130
  - Predefined ..... 404
  - Type ..... 130
  - User-defined ..... 130
  - Using as measurement filter ..... 180
- Trigger
  - Configuration (Softkey) ..... 154
  - Drop-out time ..... 157
  - External (remote) ..... 301
  - Holdoff ..... 158
  - Hysteresis ..... 157
  - Level ..... 156
  - Offset (softkey) ..... 157
  - Remote control ..... 297
  - Slope ..... 157, 301
  - Trigger level
    - External trigger (remote) ..... 300
    - I/Q Power (remote) ..... 300
    - IF Power (remote) ..... 300
  - Triggers
    - MSRA ..... 155, 298
  - Trigger source ..... 155
    - BB Power ..... 156
    - External ..... 155
    - Free Run ..... 155
    - I/Q Power ..... 156
    - IF Power ..... 156
- Troubleshooting
  - Burst search ..... 239
  - Flow chart ..... 237
  - Frequently asked questions ..... 248
  - Input overload ..... 279
  - Pattern search ..... 239
  - Result display ..... 248
  - Traces ..... 248
- U**
- Units
  - Reference level ..... 139, 144
  - X-axis ..... 150
  - X-axis, y-axis ..... 150
  - Y-axis ..... 151
- Updating
  - Result display ..... 160
  - Result display (remote) ..... 329
- Upper Level Hysteresis
  - Softkey ..... 184
- Usable I/Q bandwidth
  - Definition ..... 61
  - Result display ..... 15, 153
- Useful length
  - Bursts ..... 114
- User filters
  - Loading ..... 130
- User manuals ..... 8
- User QAM
  - Modulation type ..... 127
- User sample rate
  - Definition ..... 61
- V**
- Vector frequency
  - Result type ..... 33
- Vector I/Q
  - Result type ..... 31
- W**
- Window configuration
  - Data source ..... 197
  - Remote ..... 356
  - Result type ..... 197
  - Result type transformation ..... 197
  - Softkey ..... 196, 197
- Windows
  - Adding (remote) ..... 351
  - Closing (remote) ..... 352
  - Configuring ..... 125

Layout (remote) .....	353
Maximizing (remote) .....	350
Querying (remote) .....	352
Replacing (remote) .....	353
Splitting (remote) .....	350
Types (remote) .....	351
Window title bar information .....	14

**X**

## X-axis

Quantize .....	149
Range .....	149
Reference position .....	149, 215
Reference value .....	149, 215
Scaling .....	146
Scaling, auto (softkey) .....	148, 184
Scaling, auto all windows (softkey) .....	184
Scaling (default) .....	149
Scaling automatically .....	149
Units .....	150

**Y**

## Y-axis

Mix, max values .....	148
Range .....	216
Range per division .....	148
Reference position .....	148, 214
Reference value .....	148, 214
Scaling .....	146
Scaling, auto .....	214, 216
Scaling, auto (softkey) .....	148, 184
Scaling, auto all windows (softkey) .....	184
Scaling (statistics) .....	148
Units .....	151
YIG-preselector	
Activating/Deactivating .....	136
Activating/Deactivating (remote) .....	280

**Z**

## Zooming

Activating (remote) .....	348
Area (Multiple mode, remote) .....	348
Area (remote) .....	347
Deactivating .....	200
Multiple mode .....	200
Multiple mode (remote) .....	348, 349
Remote .....	347
Restoring original display .....	200
Single mode .....	200
Single mode (remote) .....	347